



Ibiza

Owner's manual

Vehicle identification data

Model:
Vehicle Registration:
Vehicle identification number:
Date of vehicle registration or vehicle delivery:
SEAT Official Service:
Service advisor:
Telephone:

Confirmation of receipt of documentation and vehicle keys

The following items were delivered with the vehicle:	YES	NO
On-board documentation	<input type="checkbox"/>	<input type="checkbox"/>
First key	<input type="checkbox"/>	<input type="checkbox"/>
Second key	<input type="checkbox"/>	<input type="checkbox"/>
Correct working order of all keys was checked	<input type="checkbox"/>	<input type="checkbox"/>
Location:		
Date:		
Signature of owner:		

Introduction

Thank you for your trust choosing a SEAT vehicle.

With your new SEAT, you will be able to enjoy a vehicle with state-of-the-art technology and top quality features.

We recommend reading this Instruction Manual carefully to learn more about your vehicle so you can enjoy all its benefits in your daily driving.

Information about handling is complemented with instructions regarding the operation and maintenance of the vehicle in order to ensure its safety and maintain its value. Moreover, we want to give you valuable advice and tips to drive your vehicle efficiently and respecting the environment.

We wish you safe and enjoyable motoring.

SEAT, S.A.

WARNING

Read and always observe safety information concerning the passenger's front airbag »» page 30, Fitting and using child seats.

About this manual

This manual describes the **features** of the vehicle at the time of drafting this text. Some of the features described below will be introduced in the future or will only be available in certain markets.

Some of the features described here are not included in all the types or variations of the model and they can be varied or modified based on technical or marketing requirements without it being considered misleading advertising.

Some details on the **drawings** may vary from its vehicle and must be interpreted as a standard representation.

The **direction indicators** (left, right, forwards, backwards) in this manual refer to the travel direction of the vehicle unless otherwise stated.

The **audiovisual material** is only meant to help the users better understand some features of the car. It is not a replacement for the instruction manual. Access the instruction manual to see the complete information and warnings.

★ The **features marked with an asterisk** are included by default only in certain versions of the model, supplied as optional only for certain versions or only offered in certain countries.

- Ⓢ **Trademarks** are marked with ®. The absence of this symbol does not guarantee that the term is not a trademark.
- » It indicates that the section continues on the next page.

You can access the information in this manual using:

- Thematic table of contents that follows the manual's general chapter structure.
- Visual table of contents that uses graphics to indicate the pages containing "essential" information, which is detailed in the corresponding chapters.
- Alphabetical index with many terms and synonyms to help you find information.

WARNING

Texts after this symbol contain information about safety and warn you about possible accident or injury risks.

CAUTION

Texts after this symbol indicate possible damage to the vehicle.

For the sake of the environment

Texts after this symbol contain information about the protection of the environment.

Note

Texts after this symbol contain additional information.

Digital instruction manual

The digital version of the manual can be found on SEAT's official website:



- scan the QR code »» Fig. 1
- **OR** enter the following address in the navigator website:

<http://www.seat.com/owners/your-seat/manuals-offline.html>

and select your vehicle.

Related videos

The operation of some of the vehicle's features can be shown as an instruction video:



- scan the QR code »» Fig. 2
- **OR** enter the following address in the navigator website:

<http://www.seat.com/owners/your-seat/manuals-offline.html>

choose your vehicle and then "Multimedia".

Note

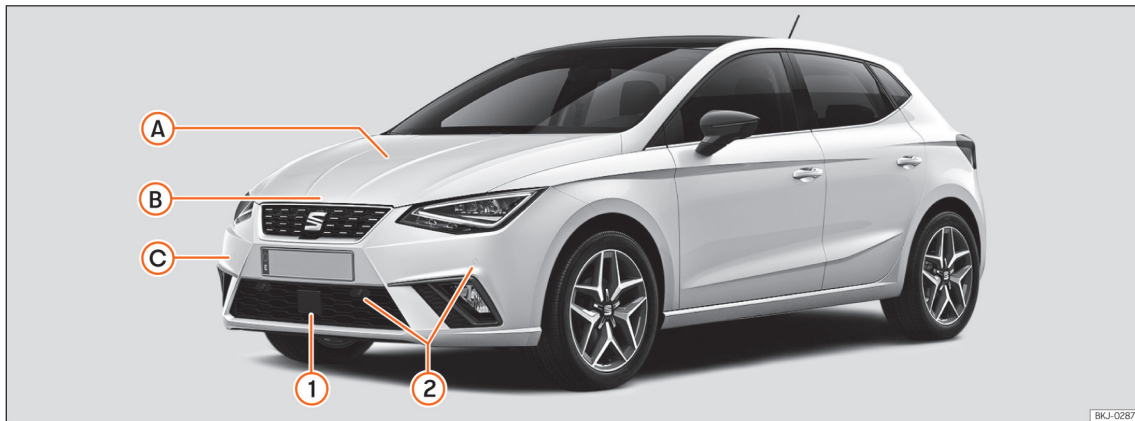
Video instructions are only available in certain languages.

Table of Contents

General views of the vehicle	7	Jump start	49	Seats and headrests	126
Exterior view	7	Tow start and towing	51	Adjusting seats	126
Exterior view	8	Fuses and bulbs	55	Headrest	127
Overview (left hand drive)	9	Fuses	55	Seat functions	128
Overview (right hand drive)	10	Changing bulbs	59	Transport and practical equipment	131
Interior view	11	Operation	67	Storing objects	131
Safety	12	Controls and displays	67	Luggage compartment	132
Safe driving	12	Interior view	67	Roof carrier*	134
Advice about driving	12	Instruments and warning/control lamps	68	Storage compartment	136
Correct sitting position of vehicle occupants	13	Instrument panel	68	Drink holder	138
Pedal area	15	Using the instrument panel	82	Power sockets	139
Seat belts	16	Control lamps	84	Air conditioning	140
The whys and wherefores of seat belts	16	Infotainment system	86	Heating, ventilation and cooling	140
How to properly adjust your seat belt	19	Multifunction steering wheel*	91	Infotainment system	146
Seat belt tensioners	21	Opening and closing	96	Introduction	146
Airbag system	22	Set of vehicle keys	96	First steps	146
Brief introduction	22	Central locking	98	Overview and controls	150
Operation of the airbags	24	Anti-theft alarm system*	105	General instructions for use	151
Transporting children safely	29	Doors	107	Data transfer	157
Safety for children	29	Rear lid	109	SEAT CONNECT	157
Emergencies	38	Window controls	110	Full Link	162
Self-help	38	Sunroof*	112	WLAN access point*	166
Information, assistance and emergency call service*	38	Lights	115	Infotainment operation	169
Emergency equipment	39	Vehicle lighting	115	voice control*	169
Tyre repairs	40	Interior lights	121	Radio/Multimedia	171
Changing a wheel	43	Visibility	122	Navigation*	178
Changing the windscreen wiper blades	48	Windscreen wiper and rear window wiper systems	122	Telephone interface	185
		Mirrors	124	Multimedia	190
		Sun protection	126	Driving	191
				Start and driving	191
				Starting and stopping the engine	191
				Start-Stop system*	196
				Manual gearbox	198

Automatic gearbox/DSG automatic gearbox*	199	Engine management and emissions control system	262
Gear-change recommendation	205	Engine compartment	264
Steering	206	Engine oil	266
SEAT Drive Profiles*	207	Cooling system	269
Driving tips	208	Brake fluid	271
Driver assistance systems	211	Windscreen washer reservoir	272
General notes	211	12-volt battery	273
Drive assist sensors and cameras	212	Wheels	276
Cruise control system (CCS)*	213	Wheels and tyres	276
Speed limiter	216	Tyre pressure loss indicator*	282
Emergency brake assistance system (Front Assist)*	219	Spare wheel	284
ACC - Adaptive Cruise Control*	222	Maintenance	286
Braking and parking	228	SEAT Maintenance Programme	286
Braking system	228	Service intervals	286
Stabilisation and brake assistance systems	231	Additional service offers	288
Parking	233	Warranty	289
Help with parking and manoeuvring	234	Vehicle maintenance	289
Parking aid parking and manoeuvring (ParkPilot)*	234	Maintenance and cleaning	289
Parking System Plus*	236	Accessories and modifications to the vehicle	294
Rear parking aid*	238	Accessories, spare parts and repair work	294
Reverse Assist (Rear View Camera)*	239	Information for the user	297
Towing bracket device*	241	Information for the user	297
Trailer mode	241	Information stored by the control units	297
Towing bracket device*	248	Other important information	297
Retrofitting a towing bracket	253	Information about the EU Directive 2014/53/EU	298
Practical tips	255	Technical data	302
Checking and refilling levels	255	Indications about the technical data	302
Refuelling	255	Important information	302
Fuel types	257	Index	307
AdBlue®	260		

Exterior view



BKJ-Q287

A Levels control

- Oil »» page 266
- Brake fluid »» page 271
- Battery »» page 273

B Bonnet

- Unlocking lever »» page 265
- Open/close »» page 265

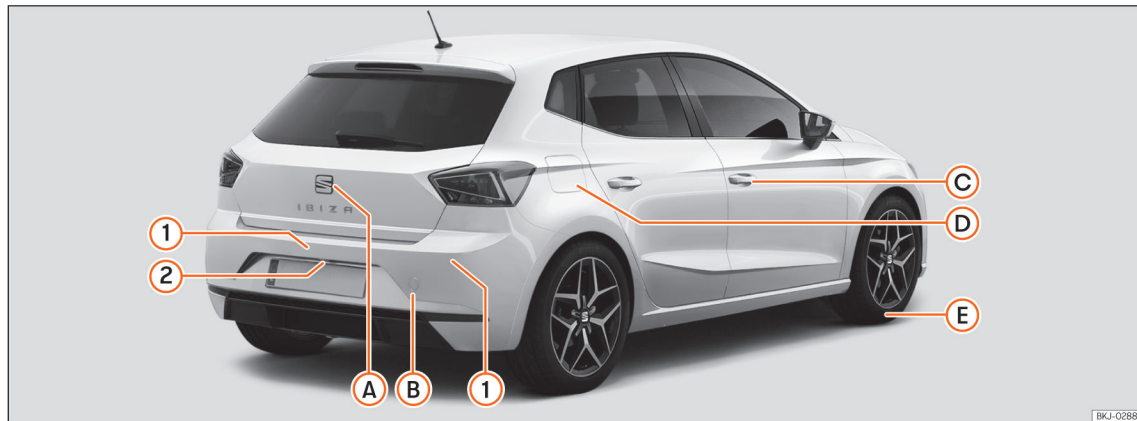
C Towing the vehicle

- Towline anchorage »» page 54
- Tow-start »» page 52

Driving assistance sensors »» page 211

- ① Front radar
- ② Parking aid sensors

Exterior view



A Rear lid

- Opening from outside »» page 110
- Emergency opening »» page 110

B Towing the vehicle

- Towline anchorage »» page 54
- Tow-start »» page 52

C Opening and closing

- Doors »» page 107
- Central locking »» page 98
- Emergency lock »» page 108

D Fuel tank

- Fuel capacity »» page 302
- Open/Close cap »» page 255

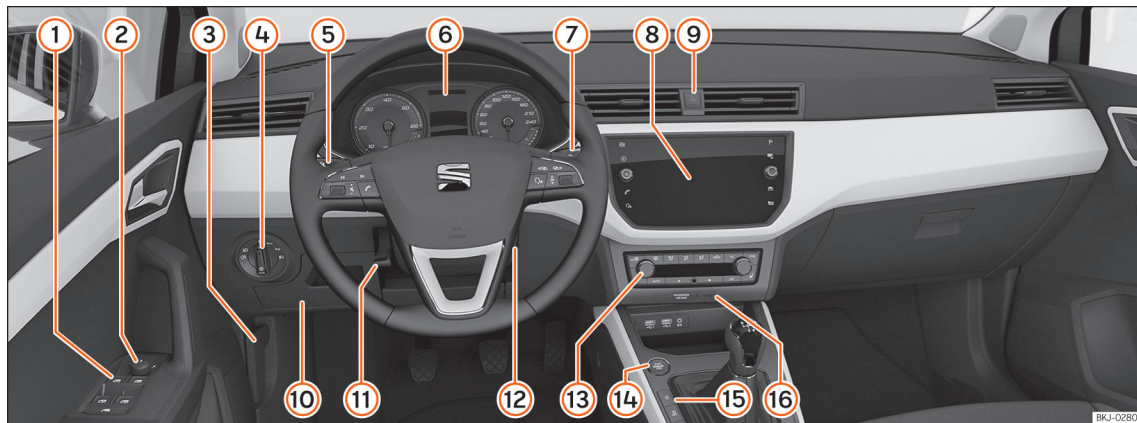
E Action in the event of a puncture

- Anti-puncture kit »» page 40
- Wheel change »» page 43

Driving assistance sensors »» page 211

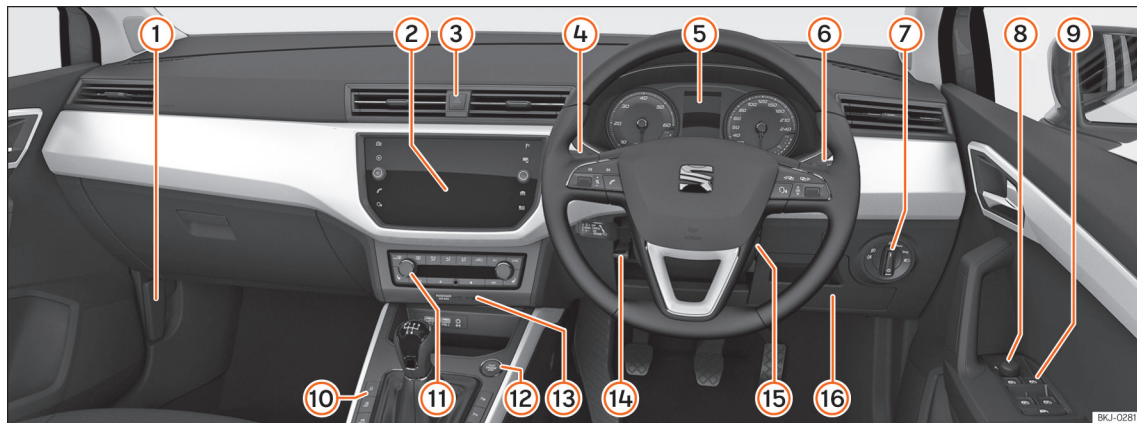
- 1** Parking aid sensors
- 2** Rear view camera

Overview (left hand drive)



- | | | |
|---|--|---|
| ① Electric windows »» page 110 | Driver information system »» page 82 | ⑬ Front passenger airbag disconnection display »» page 26 |
| ② Exterior mirror adjustment »» page 124 | ⑧ Easy Connect »» page 86 | |
| ③ Open bonnet lever »» page 265 | ⑨ Hazard warning lights »» page 119 | |
| ④ Headlight switch »» page 115 | ⑩ Fuses »» page 55 | |
| ⑤ Turn signal and main beam lever »» page 117 | ⑪ Steering wheel adjustment »» page 15 | |
| Cruise control »» page 213 | ⑫ Ignition lock »» page 191 | |
| ⑥ Warning lamps »» page 84 | ⑬ Air conditioning »» page 140 | |
| ⑦ Wipers and rear window wiper »» page 122 | ⑭ Starter button »» page 192 | |
| | ⑮ Central locking »» page 98 | |

Overview (right hand drive)



① Open bonnet lever »» page 265

② Easy Connect »» page 86

③ Hazard warning lights »» page 119

④ Turn signal and main beam lever
»» page 117

Cruise control »» page 213

⑤ Warning lamps »» page 84

⑥ Wipers and rear window wiper
»» page 122

Driver information system »» page 82

⑦ Headlight switch »» page 115

⑧ Exterior mirror adjustment »» page 124

⑨ Electric windows »» page 110

⑩ Central locking »» page 98

⑪ Air conditioning »» page 140

⑫ Starter button »» page 192

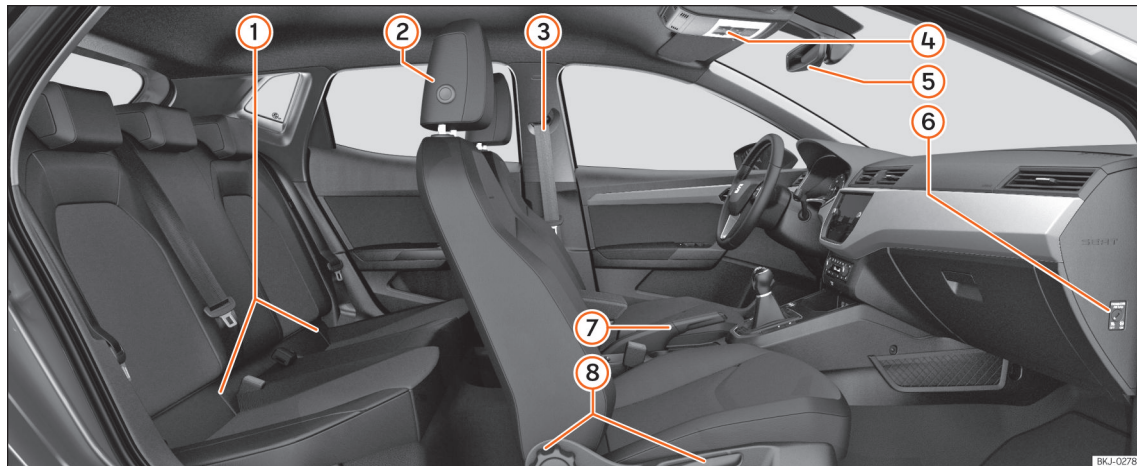
⑬ Front passenger airbag disconnection
display »» page 26

⑭ Steering wheel adjustment »» page 15

⑮ Ignition lock »» page 191

⑯ Fuses »» page 55

Interior view



① Isofix anchors »»» page 32

② Headrest adjustment »»» page 127

③ Seat belts »»» page 16

④ Panoramic roof »»» page 112

⑤ Interior mirror »»» page 124

⑥ Disconnecting the front passenger front airbag »»» page 26

⑦ Handbrake »»» page 230

⑧ Seat adjustment »»» page 126

Safety

Safe driving

Advice about driving

Safety first!

WARNING

- This manual contains important information about the operation of the vehicle, both for the driver and the passengers. The other sections of the on-board documentation also contain further information that you should be aware of for your own safety and for the safety of your passengers.
- Ensure that the on-board documentation is kept in the vehicle at all times. This is especially important when lending or selling the vehicle to another person.

Before driving

For your own safety and the safety of your passengers, always note the following points before every trip:

- Make sure that the vehicle's lights and turn signals are working properly.
- Check tyre pressure.

- Ensure that all windows provide a clear and good view of the surroundings.
- Make sure all luggage is secured »» page 131.
- Make sure that no objects can interfere with the pedals.
- Adjust front seat, headrest and mirrors properly according to your size.
- Ensure that the passengers in the rear seats always have the headrests in the in-use position »» page 127.
- Instruct passengers to adjust the headrests according to their height.
- Protect children with appropriate child seats and properly applied seat belts »» page 29.
- Assume the correct sitting position. Instruct your passengers also to assume a proper sitting position »» page 13.
- Fasten your seat belt securely. Instruct your passengers also to fasten their seat belts properly »» page 16.

Factors influencing safety

As a driver, you are responsible for yourself and your passengers.

- Always pay attention to traffic and do not get distracted by passengers or telephone calls.
- Never drive when your driving ability is impaired (e.g. by medication, alcohol, drugs).
- Observe traffic laws and speed limits.
- Always reduce your speed as appropriate for road, traffic and weather conditions.
- When travelling long distances, take breaks regularly - at least every two hours.
- If possible, avoid driving when you are tired or stressed.

WARNING

Driving under the influence of alcohol, drugs, medication or narcotics may result in severe accidents and even loss of life.

- Alcohol, drugs, medication and narcotics may significantly alter perception, affect reaction times and safety while driving, which could result in the loss of control of the vehicle.

Safety equipment

Never put your safety or the safety of your passengers in danger. In the event of an accident, the safety equipment may reduce the

risk of injury. The following points cover part of the safety equipment in your SEAT¹⁾:

- three-point seat belts,
- belt tension limiters for the front and rear side seats,
- belt tensioners for the front and rear side seats*,
- front airbags,
- side airbags in the front seat backrests,
- head-protection airbags,
- "ISOFIX" anchor points for child seats on the rear side seats with the "ISOFIX" system,
- height-adjustable front headrests,
- rear headrests with in-use position and non-use position,
- adjustable steering column.

The safety equipment mentioned above works together to provide you and your passengers with the best possible protection in the event of an accident. However, these safety systems can only be effective if you and your passengers are sitting in a correct position and use this equipment properly.

Safety is everyone's business!

Correct sitting position of vehicle occupants

Correct position on the seat

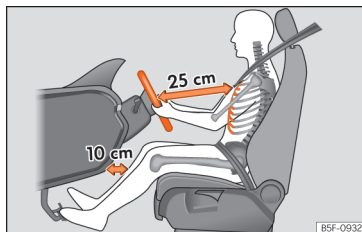


Fig. 3 The correct distance between the driver and the steering wheel must be at least 25 cm [10 inches].

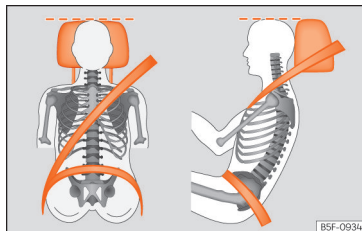


Fig. 4 Correct belt web and headrest positions

The correct sitting positions for the driver and passengers are shown below.

If your physical constitution prevents you from maintaining the correct sitting position, contact a specialised workshop for help with any special devices. The seat belt and airbag can only provide optimum protection if a correct sitting position is adopted. SEAT recommends taking your car in for technical service.

For your own safety and to reduce the risk of injury in the event of an accident or sudden braking or manoeuvre, SEAT recommend the following positions:

Valid for all vehicle occupants:

- Adjust the headrest so that its upper edge is at the same level as the top of your head, or as close as possible to the same level as the top of your head and under no circumstances below eye level. Keep the back of your neck as close as possible to the headrest »» **Fig. 4.**
- Short people must lower the headrest completely, even if your head is below its upper edge.
- Tall people must raise the headrest completely.
- Always keep your feet in the footwell while the vehicle is in motion. »»

¹⁾ Depending on the version/market.

- Adjust and fasten your seat belt correctly
»» page 19.

The following also applies to the driver:

- Move the seat backrest to an almost upright position so that your back rests completely against it.
- Move the steering wheel so it is at least 25 cm (10 inches) away from the sternum
»» Fig. 3 and you can hold it with both hands on both sides, on the outer part, with your arms slightly bent.
- The steering wheel must always point towards the chest and never towards the face.
- Move the seat in such a way that you can step on the pedals with your knees slightly bent and with a distance between the knees and the dashboard of at least 10 cm (4 inches) »» Fig. 3.
- Adjust the height of the seat so that you can reach the top of the steering wheel.
- Always keep both feet in the footwell so that you have the vehicle under control at all times.

For the passenger, the following applies:

- Move the seat backrest to an almost upright position so that your back rests completely against it.
- Move the seat as far back as possible (minimum 25 cm between the chest and the dash-

board check translation). If you are sitting closer than 25 cm, the airbag system cannot protect you properly.

Number of seats

The vehicle has **5** seats, 2 in the front and 3 in the rear. All seats are equipped with a safety belt.

WARNING

Sitting in an incorrect position may increase the risk of severe or lethal injuries in the event of sudden braking or manoeuvring, in case of collision or accident and if the airbags deploy.

- Before starting the car, all passengers must be sitting in a correct position and stay like that for the entire journey. This also applies to a correct use of the seat belt.
- The maximum amount of people in the vehicle is the same as the amount of seats with seat belts.
- For children, always use a certified protection system, certified and suited for their weight and height »» page 29.
- While driving, always keep your feet in the footwell. Never place them over the seat or the dashboard, for example, or outside the window. Otherwise the airbag and seat belt may offer insufficient protection

and also increase the risk of injury in the event of an accident.

Risks of sitting in an incorrect position

If seat belts are worn incorrectly or not at all, the risk of severe or lethal injuries increases. Seat belts can provide optimal protection only if the belt web is properly worn. Incorrect sitting positions substantially reduce the protective function of seat belts and, therefore, increase the risk of severe or even lethal injuries. The risk of severe or fatal injuries is especially heightened when a deploying airbag strikes a vehicle occupant who has assumed an incorrect sitting position. The driver is responsible for all people, particularly children, inside the vehicle.

The following list contains examples of incorrect sitting positions that could be dangerous for all vehicle occupants.

When the vehicle is in motion:

- Never stand in the vehicle.
- Never stand on the seats.
- Never kneel on the seats.
- Never tilt your seat backrest too far to the rear.
- Never lean against the dash panel.

- Never lie on the rear seats.
- Never sit on the front edge of a seat.
- Never sit sideways.
- Never lean out of a window.
- Never put your feet out of a window.
- Never put your feet on the dash panel.
- Never place your feet on the bench or on the backrest of the seat.
- Never travel in a footwell.
- Never sit on the armrests.
- Never travel without wearing the seat belt.
- Never travel in the luggage compartment.

⚠ WARNING

Sitting in an incorrect position increases the risk of severe or fatal injuries in the event of accidents and sudden braking or manoeuvres.

- All occupants must sit correctly during the journey and wear the seat belt correctly.
- Occupants of the vehicle that are not sitting correctly, not wearing the seat belt or are not at a proper distance of the airbag risk suffering very serious or lethal injuries, especially if the airbags deploy and strike them.

Steering wheel position adjustment

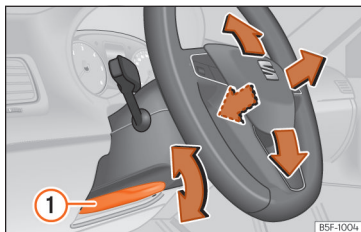


Fig. 5 Lever in the lower left side of the steering column.

Adjust the steering wheel before your trip and only when the vehicle is stationary.

- Pull the »» Fig. 5 ① lever down, move the steering wheel to the desired position and lift the lever back up until it locks.

⚠ WARNING

Incorrect use of the steering wheel adjustment function and an incorrect adjustment of the steering wheel can result in severe or fatal injury.

- After adjusting the steering column, push the lever »» Fig. 5 ① firmly upwards to ensure the steering wheel does not accidentally change position while driving.


- Never adjust the steering wheel while the vehicle is in motion. If you need to adjust the steering wheel while the vehicle is in motion, stop safely and make the proper adjustment.
- The adjusted steering wheel should be facing your chest and not your face so as not to hinder the driver's front airbag protection in the event of an accident.
- When driving, always hold the steering wheel with both hands on the outside of the ring at the 9 o'clock and 3 o'clock positions to reduce injuries when the driver's front airbag deploys.
- Never hold the steering wheel at the 12 o'clock position or in any other manner (e.g. in the centre of the steering wheel). In such cases, if the driver's airbag deploys, you may sustain injuries to your arms, hands and head.

Pedal area

Pedals

- Ensure that you can always press the accelerator, brake and clutch pedals unimpeded to the floor.
- Ensure that the pedals can return unimpeded to their initial positions.

»

- Ensure that the floor mats are securely fastened during the trip and do not obstruct the pedals »» » .

Only use floor mats which leave the pedals clear and which are secured to prevent them from slipping. You can obtain suitable floor mats from a specialised dealership. Fasteners* for floor mats are fitted in the footwells.

If a brake circuit fails, the brake pedal must be pressed down thoroughly in order to stop the vehicle.

Wear suitable footwear

Always wear shoes which support your feet properly and give you a good feeling for the pedals.

WARNING

- Restricting pedal operation can lead to critical situations while driving.
- Never lay or fit floor mats or other floor coverings over the original floor mats. This would reduce the pedal area and could obstruct the pedals. Risk of accident.
- Never place objects in the driver footwell. An object could move into the pedal area and impair pedal operation.

Seat belts


The whys and wherefores of seat belts

Control lamps




It lights up red


Driver or passenger has not fastened seat belt.

The control lamp  lights up to remind the driver to fasten their seat belt.

Before starting the vehicle:

- Fasten your seat belt securely.
- Instruct your passengers to fasten their seat belts properly before driving off.
- Protect children by using a child seat according to the child's height and weight »» page 29.

When starting to drive, if the vehicle's speed exceeds approx. 25 km/h [15 mph] and the seat belts are not fastened or are unfastened while driving, a warning sound will be heard for a few seconds. The warning light will also flash .

The lamp  goes out when the driver and passenger seat belts are fastened with the ignition switched on.

Rear seat belts fastened display*



Fig. 6 Instrument panel: left rear seat occupied and corresponding seat belt fastened display.

Depending on the model version, when the ignition is switched on, the seat belt status display »» Fig. 6 on the instrument panel informs the driver whether the passengers in the rear seats have fastened their seat belts.



It indicates that the corresponding seat is empty.



Indicates that the seat is occupied and the occupant is wearing the seat belt.

The seat belt status flashes for a maximum of 30 seconds when a seat belt in the rear seats is unfastened while the vehicle is in motion. An audible warning will also be heard if the vehicle is travelling at over 25 km/h [15 mph].

If a seat belt is fastened or unfastened while driving in some of the rear seats, the seat belt

status is displayed for approximately 30 seconds. The indication can be hidden by pressing the **0.0/SET** button on the dash panel.

The protective function of seat belts



Fig. 7 Drivers with properly worn seat belts will not be thrown forward in the event of sudden braking.

Properly worn seat belts hold the occupants in the proper position. They also help prevent uncontrolled movements that may result in serious injury and reduce the risk of being thrown out of the vehicle in case of an accident.

Vehicle occupants wearing their seat belts correctly benefit greatly from the ability of the belts to absorb kinetic energy. In addition, the front part of your vehicle and other passive safety features (such as the airbag sys-

tem) are designed to absorb the kinetic energy released in a collision. Taken together, all these features reduce the releasing kinetic energy and consequently, the risk of injury. This is why it is so important to fasten seat belts before every trip, even when "just driving around the corner".

Ensure that your passengers wear their seat belts as well. Accident statistics have shown that wearing seat belts is an effective means of substantially reducing the risk of injury and improving the chances of survival when involved in a serious accident. Furthermore, properly worn seat belts improve the protection provided by airbags in the event of an accident. For this reason, wearing a seat belt is required by law in most countries.

Although your vehicle is equipped with airbags, the seat belts must be fastened and worn. The front airbags, for example, are only triggered in some cases of head-on collision. The front airbags will not be triggered during minor frontal or side collisions, rear-end collisions, overturns or accidents in which the airbag trigger threshold value in the control unit is not exceeded.

Important safety instructions for the use of seat belts

– Always wear the seat belt as described in this section.

– Ensure that the seat belts can be fastened at all times and are not damaged.

⚠ WARNING

- If seat belts are worn incorrectly or not at all, the risk of severe injuries increases. The optimal protection from seat belts can be achieved only if you use them properly.
- Never allow two passengers (even children) to share the same seat belt.
- Never unbuckle a seat belt while the vehicle is in motion. Risk of fatal injury.
- The seat belt should never lie on hard or fragile objects (such as glasses or pens, etc.) because this can cause injuries.
- Do not allow the seat belt to be damaged or jammed, or to rub on any sharp edges.
- Never wear the seat belt under the arm or in any other incorrect position.
- Bulky and unfastened clothing (such as an overcoat over a sweater) impairs the proper fit and function of the seat belts, reducing their capacity to protect.
- The slot in the seat belt buckle must not be blocked with paper or other objects, as this can prevent the latch plate from engaging securely.
- Never use seat belt clips, fastening rings or similar items to alter the position of the belt webbing.
- Frayed or torn seat belts or damage to the connections, belt retractors or parts of

»

the buckle could cause severe injuries in the event of an accident. Therefore, you must check the condition of all seat belts at regular intervals.

- Seat belts which have been worn in an accident and have been stretched must be replaced by a specialised workshop. Renewal may be necessary even if there is no apparent damage. The belt anchorage should also be checked.
- Do not attempt to repair a damaged seat belt yourself. The seat belts must not be removed or modified in any way.
- The belts must be kept clean, otherwise the retractors may not work properly.

Head-on collisions and the laws of physics



Fig. 8 A driver not wearing a seat belt is thrown forward violently.



Fig. 9 The unbelted passenger in the rear seat is thrown forward violently, hitting the driver who is wearing a seat belt.

The effects of the laws of physics in the case of a head-on collision are easy to explain: the moment a vehicle starts moving, a type of energy called “kinetic energy” starts acting on both the vehicle and its passengers.

The amount of “kinetic energy” depends on the speed of the vehicle and on the weight of the vehicle and of its passengers. The higher they are, the more energy there is to be “absorbed” in the event of an accident.

The most significant factor, however, is the speed of the vehicle. If the speed doubles from 25 km/h (15 mph) to 50 km/h (30 mph), for example, the corresponding kinetic energy is multiplied by four.

Given that the passengers of the vehicle in our example do not have their seat belts fastened, in the event of a collision the entire

amount of the passengers' kinetic energy will be only absorbed by the mentioned impact.

Even at speeds of 30 km/h (19 mph) to 50 km/h (30 mph), the forces acting on bodies in a collision can easily exceed one tonne (1000 kg). At greater speed these forces are even higher.

Vehicle occupants not wearing seat belts are not “attached” to the vehicle. In a head-on collision, they will move forward at the same speed their vehicle was travelling just before the impact. This example applies not only to head-on collisions, but to all accidents and collisions.

Even at low speeds the forces acting on the body in a collision are so great that it is not possible to brace oneself with one's hands. In a frontal collision, unbelted passengers are thrown forward and will make violent contact with the steering wheel, dash panel, windscreen or whatever else is in the way

»» Fig. 8.

It is also important for rear passengers to wear seat belts properly, as they could otherwise be thrown forward violently through the vehicle interior in an accident. Passengers in the rear seats who do not use seat belts endanger not only themselves but also the front occupants »» Fig. 9.

How to properly adjust your seat belt

Fastening and unfastening the seat belt

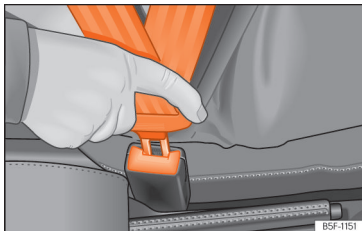


Fig. 10 Insert the latch plate of the seat belt into the buckle.

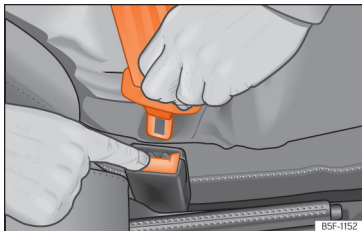


Fig. 11 Release the seat belt's buckle.

Properly worn seat belts hold the vehicle occupants in the position that most protects them in the event of an accident or sudden braking »»» ⚠.

Fastening the seat belt

Fasten your seat belt before each trip.

- Adjust the front seat and headrest correctly »»» page 13.
- Engage the seat backrest of the rear seat in an upright position »»» ⚠.
- Pull the latch plate and place the belt webbing evenly across your chest and lap. Do **not** twist the seat belt when doing so »»» ⚠.
- Engage the latch plate in the buckle of the corresponding seat »»» Fig. 10.
- Pull the belt to ensure that the latch plate is securely engaged in the buckle.

Releasing the seat belt

Only unfasten the seat belt when the vehicle has come to a standstill »»» ⚠.

- Press the red button on the buckle »»» Fig. 11. The latch plate is released from the buckle.
- Guide the belt back by hand so that it rolls up easily and the trim will not be damaged.

⚠ WARNING

- The seat belt cannot offer its full protection unless the seat backrest is in an upright position and the seat belt is worn correctly, according to your size.
- Unbuckling your seat belt while the vehicle is in motion can cause severe or fatal injuries in the event of an accident or sudden braking.
- The seat belt itself, or a loose seat belt, can cause severe injuries if the belt moves from hard areas of the body to soft areas (e.g. the stomach).

Correct seat belt position

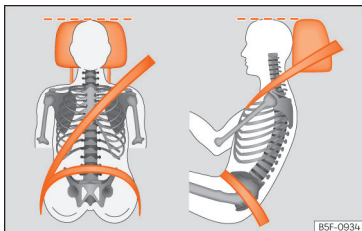


Fig. 12 Correct seat belt and headrest positions, viewed from front and the side.



Fig. 13 Position of seat belt during pregnancy.

Seat belts offer their maximum protection in the event of an accident and reduce the risk of sustaining severe or fatal injuries only when they are properly positioned. Furthermore, if the webbing is correctly positioned, the seat

belt will hold the vehicle occupants in the optimum position to ensure the airbag provides the maximum protection. The seat belt must therefore always be worn and the webbing correctly positioned.

Incorrectly worn seat belts can cause severe or even fatal injuries »» page 13, **Correct sitting position of vehicle occupants.**

- The shoulder part of the seat belt must lie on the centre of the shoulder, never across the neck or the arm, under the arm or behind the shoulder.
- The lap part of the seat belt must lie across the pelvis, never across the stomach.
- The seat belt must lie flat and fit comfortably. Pull the belt tight if necessary to take up any slack.

In the case of **pregnant women**, the seat belt must lie evenly across the chest and as low as possible over the pelvis, never across the stomach and must be worn properly at all times during the pregnancy »» **Fig. 13.**

Adapting the position of the belt webbing to your size

The position of the seat belt can be adapted by adjusting the height of the front seats.

⚠ WARNING

An incorrectly worn seat belt web can cause severe or fatal injuries in the event of an accident.

- The shoulder part of the seat belt must lie on the centre of the shoulder, never across the neck or the arm.
- The seat belt must lie flat and fit comfortably on the torso
- The lap part of the seat belt must lie across the pelvis, never across the stomach. The seat belt must lie flat and fit comfortably on the pelvis Pull the belt tight if necessary to take up any slack.
- For pregnant women, the lap part of the seat belt must lie as low as possible over the pelvis and always lie flat, "surrounding" the stomach»» **Fig. 13.**
- Do not twist the seat belt while it is fastened.
- Once the seat belt is positioned correctly, don't pull it away from your body with your hand.
- Do not lie the seat belt across rigid or fragile objects, e.g. glasses, pens or keys.
- Never use seat belt clips, retaining rings or similar instruments to alter the position of the belt webbing.

i Note

If your physical constitution prevents you from maintaining the correct position of the

belt webbing, contact a specialised workshop for help with any special devices to ensure the optimum protection of the seat belt and airbag. SEAT recommends taking your car in for technical service.

Seat belt tensioners

How the seat belt tensioner works

The seat belts for the front seats and the side rear seats¹⁾ are equipped with belt tensioners.

The belt tensioners are activated by sensors, although only in severe head-on, lateral and rear-end collisions. This retracts and tightens the seat belts, reducing the forward motion of the occupants.

The belt pre-tensioners work in combination with the airbag system. In case of overturn, the pre-tensioners do not activate unless the head airbags are deployed.

Note

- If the seat belt tensioners are triggered, a fine dust is produced. This is normal and it is not an indication of fire in the vehicle.
- The relevant safety requirements must be observed when the vehicle or components

of the system are scrapped. Specialised workshops are familiar with these regulations, which are also available to you.

Maintenance and disposal of seat belt tensioners

The belt tensioners are components of the seat belts that are installed in the seats of your vehicle. If you work on the belt tensioners or remove and install parts of the system when performing other repair work, the seat belt may be damaged. The consequence may be that, in the event of an accident, the belt tensioners function incorrectly or may not function at all.

So that the effectiveness of the seat belt tensioner is not reduced and that removed parts do not cause any injuries or environmental pollution, regulations, which are known to the specialised workshops, must be observed.

WARNING

- Improper use or repairs not carried out by qualified mechanics increase the risk of severe or fatal injuries. The belt tensioners may fail to trigger or may trigger in the wrong circumstances.

- The seat belt tensioner, seat belt and automatic retractor cannot be repaired.
- Any work on the belt tensioners and seat belts, including the removal and refitting of system parts in conjunction with other repair work, must be performed by a specialised workshop only.
- The belt tensioners will only provide protection for one accident and must be changed if they have been activated.

For the sake of the environment

Airbag modules and belt tensioners may contain perchlorate. Observe the legal requirements for their disposal.

¹⁾ Depending on version/market.

Airbag system

Brief introduction

Why is it so important to wear a seat belt and to sit correctly?

For the inflating airbags to achieve the best protection, the seat belt must always be worn properly and the correct sitting position must be assumed.

The airbag system is not a substitute for seat belts, but it is an integral part of the vehicle's overall passive safety system. Please bear in mind that the airbag system can only work effectively when the vehicle occupants are wearing their seat belts correctly and have adjusted the headrests properly. Therefore, it is most important to properly wear the seat belts at all times, not only because this is required by law in most countries, but also for your safety »» page 16, **The whys and wherefores of seat belts.**

The airbag inflates in a matter of seconds, so if you are not properly seated when the airbag is triggered, you may sustain fatal injuries. Therefore, it is essential that all vehicle occupants assume a correct sitting position while travelling.

Sharp braking before an accident may cause a passenger not wearing a seat belt to be

thrown forward into the area of the deploying airbag. In this case, the inflating airbag may inflict critical or fatal injuries on the occupant. This also applies to children.

Always maintain the greatest possible distance between yourself and the front airbag. This way, the front airbags can completely deploy when triggered, providing their maximum protection.

The most important factors for triggering the airbag are the type of accident, the angle of impact and the vehicle speed.

Whether or not the airbags are triggered depends primarily on the vehicle deceleration rate resulting from the collision and detected by the control unit. If the vehicle deceleration occurring during the collision and measured by the control unit remains below the specified reference values, the front, side and/or head-protection airbags will not be triggered. Take into account that the visible damage in a vehicle involved in an accident, no matter how serious, is not a determining factor for the airbags to have been triggered.

WARNING

- **Wearing the seat belt incorrectly or assuming an incorrect sitting position can lead to critical or fatal injuries.**
- **All vehicle occupants, including children, who are not properly belted can sustain critical or fatal injuries if the airbag is trig-**


gered. Children up to 12 years old should always travel on the rear seat. Never transport children in the vehicle if they are not restrained or the restraint system is not appropriate for their age, size or weight.

- **To reduce the risk of injury from an inflating airbag, always wear the seat belt properly »» page 16.**

Description of the airbag system

The airbag system offers additional protection for the occupants in combination with the seat belts.

The airbag system comprises the following modules (as per vehicle equipment):

- Electronic control unit
- Front airbags for driver and passenger
- Side airbags
- Head airbag
- Airbag control lamp  on the instrument panel »» page 24
- Key-operated switch for front passenger airbag
- Control lamp for disabled/enabled status of the front passenger airbag.

The airbag system operation is monitored electronically. The airbag control lamp will illuminate for a few seconds every time the ignition is switched on (self-diagnosis).

There is a fault in the system if the control lamp :

- does not light up when the ignition is switched on »» page 24,
- turns off after 4 seconds after the ignition is switched on,
- turns off and then lights up again after the ignition is switched on,
- illuminates or flashes while the vehicle is moving.

The airbag system is not triggered if:

- the ignition is switched off
- there is a minor frontal collision
- there is a minor side collision
- there is a rear-end collision
- the vehicle turns over.

WARNING

- **The seat belts and airbags can only provide maximum protection if the occupants are seated correctly »» page 13.**
- **If a fault has occurred in the airbag system, have the system checked immediately by a specialised workshop. Otherwise there is a danger that during a collision, the**

system may fail to trigger, or not trigger correctly.

Airbag activation

The airbags deploy extremely rapidly, within thousands of a second, to provide additional protection in the event of an accident. A fine dust may develop when the airbag deploys. This is normal and it is not an indication of fire in the vehicle.

The airbag system is only ready to function when the ignition is on.

In special accidents instances, several airbags may activate at the same time.

In the event of minor head-on and side collisions, rear-end collisions, overturning or roll-over of the vehicle, airbags **do not activate**.

Activation factors

The conditions that lead to the airbag system activating in each situation cannot be generalised. Some factors play an important role, such as the properties of the object the vehicle hits (hard/soft), angle of impact, vehicle speed, etc.

Deceleration trajectory is key for airbag activation.

The control unit analyses the collision trajectory and activates the respective restraint system.

If the deceleration rate is below the predefined reference value in the control unit the airbags will not be triggered, even though the accident may cause extensive damage to the car.

The following airbags are triggered in serious head-on collisions:

- Driver airbag.
- Front passenger front airbag

The following airbags are triggered in serious side-on collisions:

- Front side airbag on the side of the accident.
- Curtain (head) airbag on the side of the accident.

In an accident with airbag activation:

- the interior lights switch on (if the interior light switch is in the courtesy light position);
- the hazard warning lights switch on;
- all doors are unlocked;
- the fuel supply to the engine is cut.
- an emergency call is started* »» page 38.

Operation of the airbags

Airbag system control lamps



It lights up on the combi-instrument

Fault in the airbag system and seat belt tensioners. Have the system checked immediately by a specialised workshop.



It lights up on the dash panel

Fault in the airbag system. Have the system checked immediately by a specialised workshop.



Front passenger front airbag deactivated. Check if the airbag should be kept deactivated







It lights up on the dash panel

Front passenger front airbag activated. The control lamp turns off automatically 60 seconds after the ignition is switched on

Several warning and control lamps light up for a few seconds when the ignition is switched on, signalling that the function is being verified. They will switch off after a few seconds.

If the airbag and seat belt tensioner system control lamp  remains on or flashes, it indicates a malfunction in the airbag and seat belt tensioner system . Have the system

checked immediately by a specialised workshop.

If the front passenger airbag is deactivated, the warning lamp **PASSENGER AIR BAG OFF**  remains lit on the dash panel to remind you that the airbag is deactivated. If, with the front passenger airbag deactivated, this lamp **does not remain lit** or if it is lit along with the control lamp  on the instrument panel, there is a fault in the airbag system . If the control lamp is flashing, there is a fault in the disabling of the airbag system . Have the system checked immediately by a specialised workshop.

WARNING

In the event of a fault in the airbag and seat belt tensioner system, the airbags and seat belts may not trigger correctly, may fail to trigger or may even trigger unexpectedly.

- The vehicle occupants run the risk of sustaining severe or fatal injuries. Have the system checked immediately by a specialised workshop.
- Do not mount a child seat in the front passenger seat or remove the mounted child seat! The front passenger front airbag may deploy during an accident in spite of the fault.

CAUTION

Always pay attention to any lit control lamps and to the corresponding descrip-

tions and instructions to avoid damage to the vehicle or harm to the occupants.

Front airbags

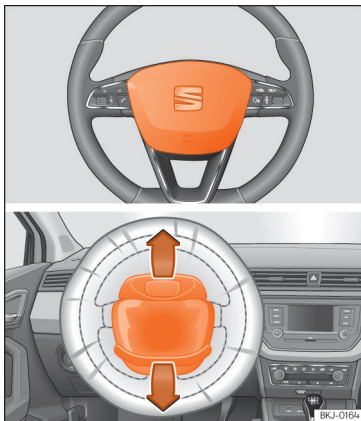


Fig. 14 Driver airbag located in steering wheel.

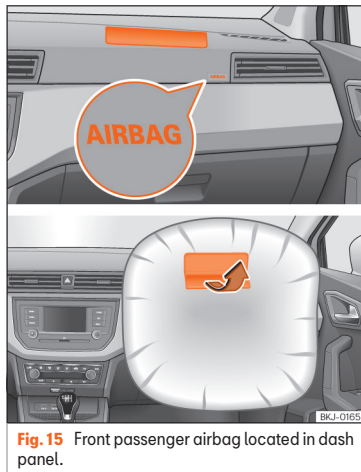


Fig. 15 Front passenger airbag located in dash panel.

The front airbag for the driver is located in the steering wheel »» Fig. 14 and the airbag for the front passenger is located in the dash panel »» Fig. 15. Airbags are identified by the word "AIRBAG".

When the driver and front passenger airbags are deployed, the covers remain attached to the steering wheel and dashboard, respectively »» Fig. 14 »» Fig. 15.

In conjunction with the seat belts, the front airbag system gives the front occupants ad-

ditional protection for the head and chest in the event of a severe frontal collision »» ⚠.

Their special design allows the controlled escape of the propellant gas when an occupant puts pressure on the bag. Thus, the head and chest are protected by the airbag. After the collision, the airbag deflates sufficiently to allow visibility.

⚠ WARNING

- The deployment space between the front passengers and the airbags must not in any case be occupied by other passenger, pets and objects.
- The airbags provide protection for just one accident; replace them once they have deployed.
- It is also important not to attach any objects such as cup holders or telephone mountings to the surfaces covering the airbag units.

Activate and deactivate front passenger front airbag*



Fig. 16 Switch for activating and deactivating the front passenger airbag.






Fig. 17 Central part of the dashboard: control lamp for the deactivation of the front passenger front airbag.

Deactivate the front passenger front airbag only if you have to use a rear-facing child seat in the front passenger seat.

SEAT recommends fitting the child seat in the rear seat to avoid having to deactivate the front passenger airbag.

When the front passenger airbag is **deactivated**, this means that only the front passenger front airbag is deactivated. All the other airbags in the vehicle remain activated.

Deactivate and activate the front passenger front airbag

- Switch the ignition off.
- Open the door on the front passenger side.
- Insert the key into the slot of the switch for deactivating the front passenger airbag
»» **Fig. 16**. About 3/4 of the key should enter; this is as far as it will go.
- Turn the key gently to change its position to **OFF** (deactivate) or to **ON** (activate). If you have difficulty, ensure that you have inserted the key as far as it will go.
- Close the front passenger door.
- When deactivating the airbag, switch the ignition on and check that the control lamp **OFF** , with the lettering **PASSENGER AIR BAG** remains lit in the middle of the dash panel
»» **Fig. 17**.
- When reactivating the airbag, check that when the ignition is switched on, the **OFF**  control lamp does not light up and the **ON**  lamp lights up or 60 seconds and then turns off.

⚠ WARNING

- The driver of the vehicle is responsible for disabling or switching on the airbag.
- Always switch off the ignition before disabling the front passenger airbag! Failure to do so could result in a fault in the airbag deactivation system.
- Never leave the key in the airbag disabling switch as it could get damaged or enable or disable the airbag during driving.
- If for any reason an airbag is deactivated, reactivate it as soon as possible so that it can fulfil its protective function.

Side airbags*

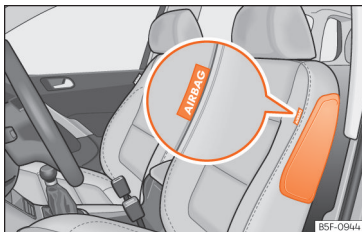


Fig. 18 Side airbag in driver's seat.

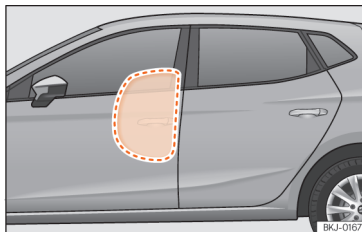


Fig. 19 Illustration of completely inflated side airbag on left side of vehicle.

The side airbags are located in the driver's seat and front passenger seat backrests
» Fig. 18.

The locations are identified by the text "AIR-BAG" in the upper region of the backrests.

In conjunction with the seat belts, the side airbag system provides additional protection for the upper body in the event of a severe side collision »» ⚠.

In a side collision, the side airbags reduce the risk of injury to passengers to the areas of the body facing the impact. In addition to their normal protection, the seat belts also hold the passengers in the event of a side collision; this is how these airbags provide maximum protection.

⚠ **WARNING**

- If you do not wear a seat belt, if you lean forward, or are not seated correctly while the vehicle is in motion, you are at a greater risk of injury if the side airbag system is triggered in an accident.
- In order for the side airbags to provide their maximum protection, the prescribed sitting position must always be maintained with seat belts fastened while travelling.
- In a side-on collision the side airbags will not work if the sensors do not correctly measure the pressure increase on the interior of the doors, due to air escaping through the areas with holes or openings in the door panel.
- Never drive if the interior door panels have been removed or if the panels have not been correctly fitted.
- Never drive the vehicle if the loudspeakers in the door panels have been removed,

unless the holes left by the loudspeakers have been closed properly.

- Always check that the openings are closed or covered if loudspeakers or other equipment are fitted inside the door panels.
- Occupants of the outer seats must never carry any objects or pets in the deployment space between them and the airbags, or allow children or other passengers to travel in this position. It is also important not to attach any accessories (such as cup holders) to the doors. This would impair the protection offered by the side airbags.
- The built-in coat hooks should be used only for lightweight clothing. Do not leave any heavy or sharp-edged objects in the pockets.
- Great forces, such as hard blows or kicks, must not be exerted upon the backrest bolster because the system may be damaged. In this case, the side airbags would not be triggered.
- Under no circumstances should protective covers be fitted over seats with side airbags unless the covers have been approved for use in your vehicle. Because the airbag deploys from the side of the backrest, the use of conventional seat covers would obstruct the side airbag, seriously reducing the airbag's effectiveness.
- Any damage to the original seat upholstery or around the seams of the side airbag »»

units must be repaired immediately by a specialised workshop.

- The airbags provide protection for just one accident; replace them once they have deployed.
- Any work on the side airbag system or removal and installation of the airbag components for other repairs (such as removal of the front seat) should only be performed by a specialised workshop. Otherwise, faults may occur during the airbag system operation.

head-protection airbags*

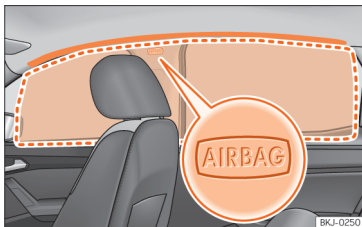


Fig. 20 Location and deployment area of the head-protection airbag.

The head-protection airbags are located on both sides in the interior above the doors » **Fig. 20** and are identified with the text "AIRBAG".

In conjunction with the seat belts, the head-protection airbag system gives the vehicle occupants additional protection for the head and upper body in the event of a severe side collision » **△**.

The area framed in red is covered by the head-protection airbag when it is deployed » **Fig. 20** (deployment area). Therefore, objects should never be placed or mounted in this area » **△**.

In the event of a side collision the head-protection airbag is triggered on the impact side of the vehicle.

The head-protection airbags reduce the risk of injury to passengers in the front and rear side seats facing the impact.

△ WARNING

- In order for the head-protection airbags to provide their maximum protection, the prescribed sitting position must always be maintained with seat belts fastened while travelling.
- For safety reasons, the head-protection airbag must be disabled in those vehicles fitted with a screen dividing the interior of the vehicle. See your technical service to make this adjustment.
- There must be no other persons, animals or objects between the occupants of the outer seats and the deployment space of the head-protection airbags so that the

head-protection airbag can deploy completely without restriction and provide the greatest possible protection. Therefore, sun blinds which have not been expressly approved for use in your vehicle may not be attached to the side windows

- The built-in coat hooks should be used only for lightweight clothing. Do not leave any heavy or sharp-edged objects in the pockets. Please, do not hang the clothes on coat hangers.
- The airbags provide protection for just one accident; replace them once they have deployed.
- Any work on the head-protection airbag system or removal and installation of the airbag components for other repairs (such as removal of the roof lining) should only be performed by a specialised workshop. Otherwise, faults may occur during the airbag system operation.
- The side and head airbags are managed through sensors located in the interior of the front doors. To ensure the correct operation of the side and head-protection airbags neither the doors nor the door panels should be modified in any way (e.g. fitting loudspeakers). If the front door is damaged, the airbag system may not work correctly. All work carried out on the front door must be done in a specialised workshop.

Transporting children safely

Safety for children

Introduction

For safety reasons, as we have learned from accident statistics, we recommend that children under 12 years of age travel in the rear seats. Depending on their age, height and weight, children travelling in rear seats must use a child seat or a seat belt. For safety reasons, the child seat should be installed in the rear seat, behind the front passenger seat or in the centre back seat.

The physical laws involved and the forces acting in a collision apply also to children »» page 18. But unlike adults, children do not have fully developed muscle and bone structures. This means that children are subject to a greater risk of injury.

To reduce the risk of injuries, children must always use special child restraint systems when travelling in the vehicle.

We recommend the use of child safety products from the SEAT Original Accessories Programme, which includes systems for all ages made by "Peke" (not for all countries) [see www.seat.com].

These systems have been especially designed and approved, complying with the ECE-R44. regulation.

SEAT recommends securing the child seats shown on the website as described below:

- Child seats in the opposite direction of travel (group 0+): ISOFIX and support bracket (Peke GO Plus + ISOFIX Base (RWF)).
- Child seats in the direction of travel (group 1): ISOFIX and Top Tether (Peke G1 ISOFIX DUO Plus).
- Child seats directed towards the front of the vehicle for group 2: safety belt and ISOFIX (RÖMER KIDFIX XP®).
- Child seats directed towards the front of the vehicle for group 3: safety belt and ISOFIX (TATAKI MAXI PLUS®).

Follow the manufacturer's instructions and observe any statutory requirements when installing and using child seats. Always read and note »» page 30.

We recommend you always carry the manufacturer's Child Seat Instruction Manual together with the on-board documentation.

Child seats group classification



Fig. 21 Examples of child seats.

Use only child seats that are officially approved and suitable for the child.

These seats are subject to the ECE-R44 or ECE-R129 standards. ECE-R stands for: Economic Commission for Europe Regulation.

Child seats by weight group

The child seats are grouped into 5 categories:

Age group	Weight of the child
Group 0	Up to 10 kg
Group 0+	Up to 13 kg
Group 1	From 9 to 18 kg
Group 2	From 15 to 25 kg
Group 3	From 22 to 36 kg

»

Child seats that have been tested and approved under the ECE R44 or ECE-R129 standards bear the ECE-R44 or ECE-R129 test marks on the seat (the letter E in a circle with the test number below it).

Follow the manufacturer's instructions and observe any statutory requirements when installing and using child seats.

We recommend you to always include the manufacturer's Child Seat Instruction Manual together with the on-board documentation.

SEAT recommends you use child seats from the **Original Accessories Catalogue**. These child seats have been designed and tested for use in SEAT vehicles. You can find the right child seat for your model and age group at SEAT dealers.

Child seats by approval category

Child seats may have the approval category of universal, semi-universal, vehicle specific (all according to the ECE-R44 standard) or i-Size (according to the ECE-R129 standard).

- **Universal:** child seats with universal approval can be installed in all vehicles. There is no need to consult any list of models. In the case of universal approval for ISOFIX, the child seat is additionally provided with a Top Tether belt.
- **Semi-universal:** semi-universal approval, in addition to the standard requirements of

universal approval, requires safety devices to lock the child seat, which require additional testing. Child seats with semi-universal approval include a list of vehicle models for which they can be installed.

- **Vehicle-specific:** vehicle-specific approval requires a dynamic test of the child seat for each vehicle model separately. Child seats with vehicle-specific approval also include a list of vehicle models for which they can be installed.
- **i-Size:** child seats with i-Size approval must meet the requirements set out in the ECE-R129 standard in relation to installation and safety. Child seat manufacturers can tell you which seats have i-Size approval for this vehicle.

Fitting and using child seats



Fig. 22 Airbag sticker: on the passenger's sun visor



Fig. 23 Airbag sticker: on the rear frame of the passenger side door

Warnings about fitting a child seat

Take the following general warnings into account if you are going to fit a child seat. They are valid for all child seats regardless of their attachment system.

- Please read and follow the child seat manufacturer's operating instructions.
- The child seat should preferably be fitted to the rear seat behind the front passenger seat so that the child can exit the vehicle on the pavement side.
- Set the height of the seat belt such that it adapts to the child seat naturally, without twisting. The lowest position of the seat belt height regulator must be used with rear-facing child seats.

- To correctly use a child seat in the back, the front backrest must be adjusted so that there is no contact with the child seat in the back in the case that it goes opposite to the direction of the car. In the case of front facing restraint systems, the front backrest must be adjusted so that there is no contact with the child's feet.
- If a semi-universal type chair is to be installed, in which the method of attachment to the car is through the seat belt and support bracket, it should never be installed in the central rear seat as the ground clearance is lower than in other places and the support bracket will not allow the seat to remain sufficiently stable.
- When fitting a child seat on the front passenger seat, the seat must be moved backwards as far as possible and placed in the highest position. The backrest must also be put in a vertical position¹⁾.

Important information about the front passenger front airbag

A sticker with important information about the passenger airbag is located on the passenger's sun visor and/or on the passenger side door frame »» Fig. 22.

¹⁾ Compliance with current national legislation and the manufacturer's instructions is required when using or installing child seats.

Read and always observe the safety information included in the following chapters:

- Safety distance with respect to the passenger airbag »» page 22.
- Objects between the passenger and the passenger side airbag »» ⚠ in Front airbags on page 25.

The passenger side front airbag, when enabled, is a serious risk for a child that is facing backward since the airbag can strike the seat with such force that it can cause serious or fatal injuries. Children up to 12 years old should always travel on the rear seat.

Therefore we strongly recommend you to transport children on the rear seats. This is the safest location in the vehicle. Alternatively, the front passenger airbag can be disabled with a key-operated switch »» page 26. When transporting children, use a child seat suitable for the age and size of each child »» page 29.

⚠ WARNING

- **If a child seat is secured to the front passenger seat, the risk to the child of sustaining critical or fatal injuries in the event of an accident increases.**

- **An inflating front passenger airbag can strike the rear-facing child seat and project it with great force against the door, the roof or the backrest.**
- **Never install a child seat facing backwards on the front passenger seat unless the front passenger front airbag has been disabled. Risk of potentially fatal injuries to the child! However, if necessary, the front passenger front airbag must be deactivated »» page 26. If the passenger seat has a height adjustment option, move it to the highest, most upright position. If you have a fixed seat, do not install any child restraint system in this location.**
- **For those vehicles that do not include a key lock switch to deactivate the airbag, the vehicle must be taken to a technical service. Do not forget to reconnect the airbag when an adult wants to sit in the front passenger seat.**
- **Never allow a child to be transported in a vehicle without being properly secured, or to stand up or kneel on a seat while travelling. In an accident, the child could be flung through the vehicle, causing possibly fatal injuries to themselves and to the other vehicle occupants.**
- **Never leave a child alone in the child seat or in the vehicle.** »»

- **Children who are less than 1.5 metres tall must not wear a normal seat belt without a child seat, as this could cause injuries to the abdominal and neck areas during a sudden braking manoeuvre or in an accident.**
- **When a child seat is mounted in the rear seats, the door child-proof lock should be activated »» page 109.**

Attachment systems

Depending on the country, different attachment systems are used for safely installing child seats.

Attachment systems overview

- **ISOFIX:** ISOFIX is a standardised attachment system allowing quick and safe attachment of child seats in the vehicle. ISOFIX attachment establishes a rigid connection between the child seat and the car body.


The child seat has two rigid attachment clips, called connectors. These connectors are fit-

ted into the ISOFIX attachment rings found between the seat cushion and the backrest of the vehicle's back seat (on the sides). ISOFIX attachment systems are used mainly in Europe »» page 33. If necessary, ISOFIX attachment may have to be supplemented with a Top Tether belt or a support bracket.

- **Automatic three-point seat belt.** Whenever possible, it is preferable to attach the child seats with the ISOFIX system rather than attaching them with an automatic three-point seat belt »» page 36.

Additional attachment:

- **Top Tether:** the Top Tether belt is guided over the back of the rear seat and attached to an anchor point with a hook. Anchor points are located at the back of the rear seat backrest on the boot side »» page 35. The rings for retaining the Top Tether belt are marked with an anchor symbol.
- **Support bracket:** some child seats rest on the floor of the vehicle with a support bracket. The support bracket prevents the child seat from tipping forward in the event of impact.

Child seats fitted with a support bracket should only be used in the passenger seat and side rear seats »» . For the assembly of this type of seat you should also consult the list of approved vehicles for this assembly, available in the instructions for child restraint systems.

Recommended systems for attaching child seats

SEAT recommends attaching child seats as follows:

- **Baby carriers or child seats in the opposite direction of travel:** ISOFIX and support bracket or i-Size.
- **Child seats in the direction of travel:** ISOFIX and Top Tether.

WARNING

Incorrect use of the support bracket can cause serious or fatal injury.

- **Make sure the support bracket is correctly and safely installed.**

Fit a child seat with the ISOFIX / i-Size and Top Tether* system

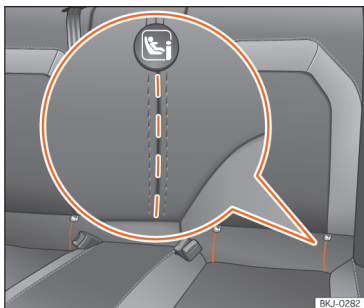


Fig. 24 Rear seat: slots die cut to access the ISOFIX / iSize securing rings.

Child seats can be secured quickly, easily and safely on the rear side seats with the "ISOFIX" and Top Tether* system.

Two "ISOFIX" retaining rings are fitted on each rear side seat. In some vehicles, the rings are

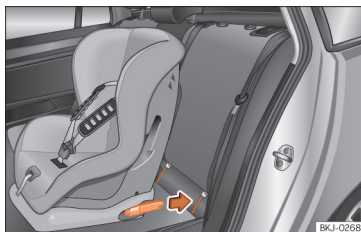


Fig. 25 Rear seats: fitting a child seat with the ISOFIX system.

secured to the seat frame and, in others, they are secured to the rear floor. The "ISOFIX" rings are located between the rear seat backrest and the seat cushioning » **Fig. 24**. The Top Tether* rings are located on the rear part of the backrests of the rear seats (be-

hind the seat backrest or in the boot) » **page 35**.

To understand the compatibility of the "ISOFIX" systems in the vehicle, check the table below.

Age group	Height classification	Front passenger seat	Side rear seats	Middle rear bench seat
Group 0: up to 10 kg	E	X	IL-SU	X
Group 0+: up to 13 kg	E	X	IL-SU	X
	D	X		X
	C	X		X

»

Safety

Age group	Height classification	Front passenger seat	Side rear seats	Middle rear bench seat
Group 1: from 9 to 18 kg	D	X	IL-SU, IUF	X
	C	X		X
	B	X		X
	B1	X		X
	A	X		X
Group 2: from 15 to 25 kg	–	X	IL-SU	X
Group 3: from 22 to 36 kg	–	X	IL-SU	X
i-Size child restraint system	–	X	i-U	X

Height classification: The height classification indication is equivalent to the authorised bodyweight for the child seat. In the case of child seats with universal or semi-universal approval, the height classification is shown on the ECE approval label. The height classification is specified on each child seat.

X: Vehicle seat unsuitable for fitting this group of child seat.

IL-SU: Vehicle seat suitable for fitting an ISOFIX child seat with semi-universal approval. The vehicle list provided by the child seat manufacturer must be consulted.

IUF: Vehicle seat suitable for fitting an ISOFIX child seat with universal approval.

i-U: Vehicle seat suitable for fitting a forward- or rear-facing i-Size child seat with universal approval.

Vehicle seat suitable for fitting a forward- or rear-facing i-Size child seat with universal approval. Vehicle seat suitable for fitting a forward-facing i-Size child seat with universal approval.

Securing the child seat with the “ISOFIX/i-Size” system

You are obliged to follow the seat manufacturer's instructions.

- Open the cut-out section behind the marked grooves to access the retaining rings
»» Fig. 24.
- Press the child seat onto the “ISOFIX/iSize” retaining rings until the child seat is heard to engage securely »» Fig. 25. If the child seat is

equipped with Top Tether* anchor points, secure it to the correspondent ring
»» page 35. Observe the manufacturer's instructions.

- Pull on both sides of the child seat to ensure that it is properly anchored.

Child seats with the “ISOFIX” and Top Tether* attachment system are available from Technical Services.

WARNING

The retaining rings are designed only for use with “ISOFIX” and Top Tether* system child seats.

- Never secure other child seats that do not have the “ISOFIX” or Top Tether* system, or retaining belts or objects to the fastening rings - this can result in potentially fatal injuries to the child.

- Ensure that the child seat is secured correctly using the "ISOFIX" and Top Tether* securing rings.

Top Tether* securing belts

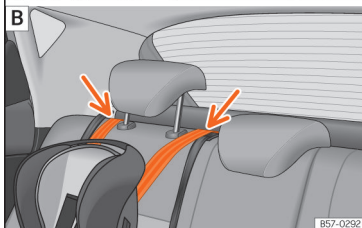
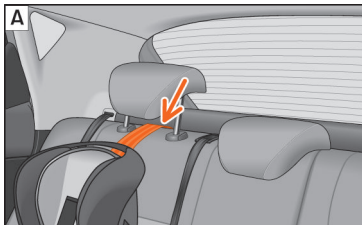


Fig. 26 Rear seats: adjustment and assembly according to the Top Tether belt.

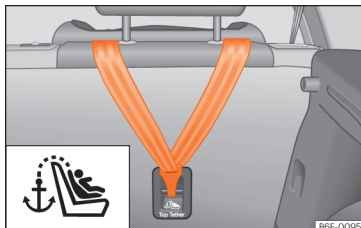


Fig. 27 Back of the rear seats: Top Tether securing rings.

Child seats with the Top Tether system come with a strap for securing the seat to the vehicle anchor point, located at the back of the rear seat backrest and provide greater restraint.

The objective of this strap is to reduce forward movements of the child seat in a crash, to reduce the risk of injuries to the head from hitting the inside of the vehicle.

Using the Top Tether in rear-facing mounted seats

Currently, there are very few rear-facing child safety seats that have Top Tether. Please carefully read and follow the seat manufacturer instructions to learn the proper way to install the Top Tether strap.

Securing the retainer strap

- Follow the manufacturer's instructions to deploy the child seat Top Tether retaining strap.
- Place the belt under the headrest of the back seat »» Fig. 26 (depending on the instructions of the chair itself, lift or remove the headrest if necessary).
- Slide the strap and secure it properly with the anchorage of the backrest »» Fig. 27.
- Firmly tighten the strap following the manufacturer's instructions.

Releasing the retaining strap

- Loosen the strap following the manufacturer's instructions.
- Push the lock and release it from the anchoring support.

⚠ WARNING

An undue installation of the safety seat will increase the risk of injury in the event of a crash.

- Never tie the retainer strap to a hook in the luggage compartment.
- Never secure or tie luggage or other items to the lower anchorages (ISOFIX) or the upper ones (Top Tether).

Fitting a child seat using the seat belt

If you want to fit a universal approval category (U) child seat in your vehicle, you must check that the seat is approved for your vehi-

cle. You will find any necessary information on the child seat's orange ECE approval la-

bel. The following table shows the different fitting options.

Age group		Weight of the child	Front passenger seat		Rear seats
			Front passenger air-bag activated	Front passenger air-bag deactivated	
Group 0		Up to 10 kg	X	U	U
Group 0+		Up to 13 kg	X	U	U
Group 1	Rear-facing	From 9 to 18 kg	X	U	U
	Forward-facing	From 9 to 18 kg	U	X	U
Group 2		From 15 to 25 kg	U	X	U
Group 3		From 22 to 36 kg	U	X	U

U: universal.

X: vehicle seat unsuitable for fitting this group of child seat.

Fitting a child seat using the seat belt

- Set the height of the seat belt such that it adapts to the child seat naturally, without twisting. The lowest position of the seat belt height regulator must be used with rear-facing child seats.
- Put the seat belt in place and pass it through the child seat according to the instructions of the child seat manufacturer.
- Make sure that the seat belt is not twisted.

- Insert the latch plate into the seat's buckle until you hear the engagement click.

WARNING

When travelling, children must be secured in the vehicle with a restraint system suitable for age, weight and size.

- **Read and always observe information and warnings concerning the use of child seats»» page 30.**

Fitting a child seat to the middle seat of the rear bench using the seat belt

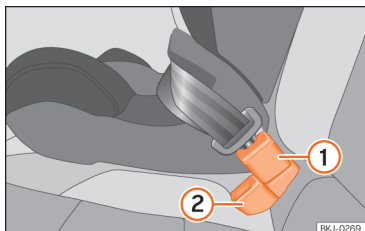


Fig. 28 Position of the belt buckle on the rear seat

- ① Belt buckle for the middle seat
- ② Belt buckle for the side seat

Child seats must always be fitted in the middle of a vehicle seat. Take into account these instructions to ensure that this is possible on the middle seat of the rear bench:

- Place the middle seat's belt buckle
»» **Fig. 28** ① behind the side seat's belt buckle »» **Fig. 28** ②.
- Plug the middle seat's seat belt into the middle seat's belt buckle »» **Fig. 28** ① and make sure it clicks in place.
- For seat belts to be correctly fitted, the buckles must not be twisted »» **Fig. 28**.

Emergencies

Self-help

Information, assistance and emergency call service*

How it works

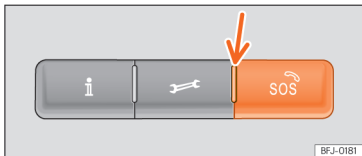


Fig. 29 On the roof console: voice service controls

Depending on the equipment, there is a control on the roof console.

By pressing the buttons **i**, **🔧** and **SOS** **»» Fig. 29**, you can run the following voice services:

- information call
- assistance call
- emergency call service.

A built-in control unit establishes the connection.

When a voice service is activated, a connection is established with a phone line.

Control lamp

The control has a warning lamp **»» Fig. 29** (arrow). It shows the following statuses:

- **Off**: the eCall service is not available.
- **Flashes red, approx. 20 seconds after switching on the ignition**: the eCall service is off.
- **Lights up red**: system failure. The eCall service is available with certain restrictions. SEAT suggests going to a specialised workshop.
- **Lights up green**: the eCall service is available. The system works correctly.
- **Flashes green**: There is an ongoing voice connection.

i Information call¹⁾

With the information call, a call is made to SEAT, S.A. customer service.

🔧 Breakdown call¹⁾

With the assistance call you can directly request specialised help in the event of a breakdown.

Parallel to the voice call, some vehicle data is transmitted, e.g. your current location.

SOS Emergency call service¹⁾

If an emergency call is conducted manually or activated automatically in the event of an accident with an airbag triggering, information relevant to the emergency is broadcast, e.g. the current location of the vehicle **»» page 297**.

If the call is public, the person on the other end of the line uses the language of the country in which you are located.

If the call is private, the person on the other end of the line will assist you in the language you have configured in the Infotainment system. If the configured language is not available, English will be used.

Diversion to 112 emergency number

In some situations where the emergency call service is limited or cannot be carried out, an emergency call is made to 112.

¹⁾ Only available in certain countries.

The following conditions may cause the emergency call service to function in a limited manner or the call to be diverted to the 112 emergency number:

- The emergency call is made from an area with weak or no mobile and GPS signal, as well as e.g. tunnels, between very tall buildings, garages, underground walkways, mountains and valleys.
- In areas with sufficient mobile telephone and GPS coverage, the mobile telephone network of the telecommunications operator in question may not be available.
- In some countries, the emergency call service may not be available due to legal reasons. There is no valid license for the use of the emergency call service.
- The components of the vehicle required for the emergency phone call are damaged or do not get enough power.
- In some countries, the emergency call service may not be available and depending on the location of the vehicle, the control lamp LEDs, and even the operation of the different types of calls, could have a specific behaviour.

Note

Breakdown service and information calls can incur an additional cost on your telephone bill.

Emergency equipment

First aid kit, warning triangle and fire extinguishers*

Warning triangle

The use of reflective warning triangles is obligatory in emergencies in some countries. As are the first aid kit and a set of spare light bulbs.

The warning triangle is under the storage compartment which is located under the luggage compartment floor.

First aid kit

The first-aid kit can go in the storage compartment which is located under the luggage compartment floor.

The first aid kit must comply with legal requirements. Check the expiry date of the contents of the first aid kit.

Fire extinguisher

The fire extinguisher* is attached to the luggage compartment carpet with Velcro.

The fire extinguisher must conform to legal requirements, be ready for use and be checked regularly. Check the certification seal on the extinguisher.

WARNING

Loose objects in the vehicle interior can be violently thrown in case of a sudden manoeuvre or braking and especially in accidents causing serious injury.

- Secure or store fire extinguishers, first aid kit, reflective vests and warning triangle securely in the vehicle.

Note

- The first aid kit, warning triangle, reflective vests and fire extinguishers are not part of the vehicle's standard equipment.
- The warning triangle should meet legal requirements.
- Before acquiring accessories and emergency equipment see the instructions in "Accessories and spares" »» page 294.

Vehicle tool kit

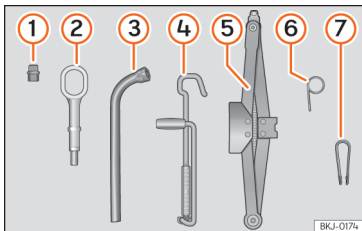


Fig. 30 Underneath the floor panel of the luggage compartment: vehicle tool kit.

The vehicle tool kit is located under the floor panel in the luggage compartment. To access the vehicle tools » page 132.

The tool kit includes:

- ① Adapter for the anti-theft bolt*
- ② Towing eye, removable
- ③ Wheel spanner*
- ④ Crank handle for jack
- ⑤ Jack*
- ⑥ Hook for extracting the central wheel trims*
- ⑦ Clip for removing the wheel bolt caps

Some of the items listed are only provided in certain model versions, or are optional extras.

⚠ WARNING

When the vehicle tool kit, tyre mobility set and spare wheel are loose in the interior they can be violently thrown in case of a sudden manoeuvre or braking and especially in accidents, causing serious injury.

- Ensure that the vehicle tool kit, the tyre mobility set and the spare wheel or temporary spare wheel are safely secured in the luggage compartment.

⚠ WARNING

Unsuitable or damaged vehicle tools can cause injury or accidents.

- Never work with inappropriate or damaged tools.

i Note

The jack does not generally require any maintenance. If required, it should be greased using universal type grease.

Tyre repairs

TMS (Tyre Mobility System)*

The Anti-puncture kit* (Tyre Mobility System) will reliably seal punctures caused by the penetration of a foreign body of up to about

4 mm in diameter. **Do not remove foreign objects, e.g. screws or nails, from the tyre.**

After inserting the sealant residue in the tyre, you must again check the tyre pressure about 10 minutes after starting the engine.

You should only use the tyre mobility set if the vehicle is parked in a safe place, you are familiar with the procedure and you have the necessary tyre mobility set! Otherwise, you should seek professional assistance.

Do not use the tyre sealant in the following cases:

- If the wheel rim has been damaged.
- In outside temperatures below -20°C [-4°F].
- In the event of cuts or perforations in the tyre greater than 4 mm.
- If you have been driving with very low pressure or a completely flat tyre.
- If the sealant bottle has passed its use by date.

⚠ WARNING

Using the tyre mobility system can be dangerous, especially when filling the tyre at the roadside. Please observe the following rules to minimise the risk of injury:

- Stop the vehicle safely as soon as possible. Park it at a safe distance from surrounding traffic to fill the tyre.

- Ensure the ground on which you park is flat and solid.
- All passengers and particularly children must keep a safe distance from the work area.
- Turn on the hazard warning lights to warn other road users.
- Use the tyre mobility system only if you are familiar with the necessary procedures. Otherwise, you should seek professional assistance.
- The tyre mobility set is intended for temporary emergency use only until you can reach the nearest specialised workshop.
- Replace the repaired tyre with the tyre mobility set as soon as possible.
- The sealant is a health hazard and must be cleaned immediately if it comes into contact with the skin.
- Always keep the tyre mobility set out of the reach of small children.
- Always stop the engine, apply the hand brake and put it in gear when using a manual gearbox, in order to reduce the risk of involuntary movement of the vehicle.

⚠ WARNING

A tyre filled with sealant does not have the same performance properties as a conventional tyre.

- Never drive faster than 80 km/h (50 mph).

- Avoid heavy acceleration, hard braking and fast cornering.
- Drive for only 10 minutes at a maximum speed of 80 km/h (50 mph) and then check the tyre.

♻ For the sake of the environment

Dispose of used or expired sealant observing any legal requirements.

📄 Note

A new bottle of sealant can be purchased at SEAT dealerships.

📄 Note

Take into account the separate instruction manual of the tyre mobility set* manufacturer.

Anti-puncture kit contents*

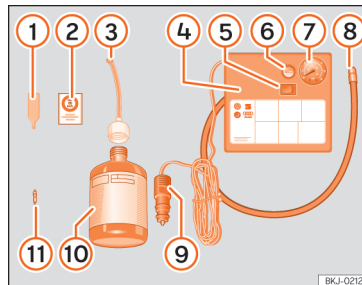


Fig. 31 Standard representation: anti-puncture kit contents.

The anti-puncture kit is located underneath the floor covering in the luggage compartment. It includes the following components

» **Fig. 31:**

- ① Valve insert remover
- ② A sticker to be adhered to the instrument cluster, within the driver's visual field, to remind that the maximum advisable speed "max. 80 km/h" or "max. 50 mph"
- ③ Filler tube with cap
- ④ Air compressor
- ⑤ ON/OFF switch
- ⑥ Air bleed screw [it can also be integrated in the inflator tube].

»

- 7 Warning provided by tyre pressure monitoring system (it can also be integrated in the inflator tube).
- 8 Tube for inflating tyres
- 9 12 volt connector
- 10 Bottle of sealant
- 11 Spare tyre valve

The **valve insert remover** ① has a gap at the lower end for a valve insert. The valve insert can only be screwed or unscrewed in this way. This also applies to its replacement part ⑪.

Sealing and inflating a tyre

Sealing the tyre

- Unscrew the tyre valve cap and insert. Use the »» Fig. 31 ① tool to remove the insert. Place it on a clean surface.
- Shake the tyre sealant bottle vigorously »» Fig. 31 ⑩.
- Screw the inflator tube »» Fig. 31 ③ into the sealant bottle. The bottle's seal will break automatically.
- Remove the lid from the filling tube »» Fig. 31 ③ and screw the open end of the tube into the tyre valve.
- With the bottle upside down, empty **all** of the contents into the tyre.

- Remove the bottle from the valve.
- Place the insert back into the tyre valve using the tool »» Fig. 31 ①.

Inflating the tyre

- Screw the compressor tyre inflator tube »» Fig. 31 ⑧ into the tyre valve.
- Check that the air bleed screw is closed »» Fig. 31 ⑥.
- Start the engine and leave it running.
- Insert the connector »» Fig. 31 ⑨ into the vehicle's 12-volt socket »» page 139.
- Turn the air compressor on with the ON/OFF switch »» Fig. 31 ⑤.
- Keep the air compressor running until it reaches 2.0 to 2.5 bar (29-36 psi/200-250 kPa). **A maximum of 8 minutes.**
- Disconnect the air compressor.
- If it does not reach the pressure indicated, unscrew the tyre inflator tube from the valve.
- Move the vehicle 10m so that the sealant is distributed throughout the tyre.
- Screw the compressor tyre inflator into the valve.
- Repeat the inflation process.
- If the indicated pressure still cannot be reached, the tyre is too badly damaged. Stop and request assistance from an authorised technician.

- Disconnect the air compressor. Unscrew the tyre inflator tube from the tyre valve.
- When the tyre pressure is between 2.5 and 2.0 bars, continue driving without exceeding 80 km/h (50 mph).
- Attach the sticker »» Fig. 31 ② to the instrument cluster, within the driver's visual field.
- Check the pressure again after 10 minutes »» page 43.

WARNING

When inflating the wheel, the air compressor and the inflator tube may become hot.

- **Protect hands and skin from hot parts.**
- **Do not place the hot flexible inflator tube or hot air compressor on flammable material.**
- **Allow them to cool before storing the device.**
- **If it is not possible to inflate the tyre to at least 2.0 bars (29 psi / 200 kPa), the tyre is too badly damaged. The sealant is not in a good condition to seal the tyre. Do not continue driving. Seek specialist assistance.**

CAUTION

Switch off the air compressor after a maximum of 8 operational minutes to avoid overheating! Before switching on the air compressor again, let it cool for several minutes.

Check after 10 minutes of driving

Screw the inflator tube »» Fig. 31 ⑤ again and check the pressure on the gauge ⑥.

1.3 bar (19 psi / 130 kPa) and lower:

- **Stop the vehicle!** The tyre cannot be sealed sufficiently with the tyre mobility set.
- You should obtain professional assistance »» ⚠.

1.4 bar (20 psi / 140 kPa) and higher:

- Set the tyre pressure to the correct value again.
- Carefully resume your journey until you reach the nearest specialised workshop without exceeding 80 km/h (50 mph).
- Have the damaged tyre replaced.

⚠ WARNING

Driving with an unsealed tyre is dangerous and can cause accidents and serious injury.

- Do not continue driving if the tyre pressure is 1.3 bar (19 psi / 130 kPa) and lower.
- Seek specialist assistance.

Changing a wheel

What to do first

- Park the vehicle on a horizontal surface and in a safe place as far away from traffic as possible.
- Apply the handbrake.
- Switch on the hazard warning lights.
- *Manual transmission:* select the 1st gear.
- *Automatic transmission:* Move the selector lever to position **P**.
- If you are towing a trailer, unhitch it from your vehicle.
- Have the vehicle tool kit »» page 40 and the spare wheel* ready »» page 284.
- Observe the applicable legislation for each country (reflective vest, warning triangles, etc.).
- All occupants should leave the vehicle and wait in a safe place (for instance behind the roadside crash barrier).

⚠ WARNING

- Always observe the above steps and protect yourself and other road users.
- If you change the wheel on a slope, block the wheel on the opposite side of the car with a stone or similar to prevent the vehicle from moving.

Wheel central trim*

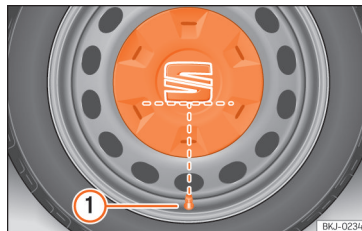


Fig. 32 Correct positioning of the central wheel trim for steel rims.

The central trims must be removed for access to the wheel nuts.

Removing

- Attach the wire hook (vehicle tools »» page 40) to one of the recesses of the central wheel trim and remove it.

Fitting

- Fit the central wheel trim onto the rim. The bottom of the "S" of the SEAT badge should align with the inflation valve »» Fig. 32 ①.
- Press the central trim firmly until it locks in with an audible click. »»

i Note

There is also a valve mark on the back of the central wheel trim that indicates the correct alignment.

Integral wheel trim

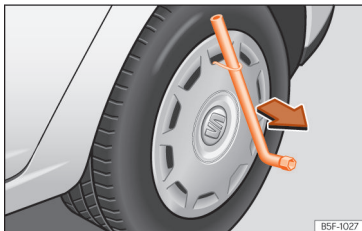


Fig. 33 Remove the wheel cover.

The wheel covers must be removed for access to the wheel nuts.

Removing

- Take the wheel brace and the wire hook from the vehicle tool kit »» page 40.
- Hook the wire through one of the grooves of the trim.
- Insert the box spanner through the hook, rest it on the tyre and remove the wheel trim »» Fig. 33.

Fitting

- Press the trim against the wheel so that the hole for the valve fits over the tyre valve.
- Make sure that the trim is correctly fitted all the way around the wheel. If you are using an anti-theft wheel lock, screw it in the opposite position to the valve.

Wheel bolt caps*



Fig. 34 Wheel: wheel nuts with caps.

Removal

- Fit the plastic clip (vehicle tools »» Fig. 30) over the cap until it clicks into place »» Fig. 34.
- Remove the cap with the plastic clip.

The caps protect the wheel nuts and should be remounted after changing the tyre.

The **anti-theft wheel locking bolt** has a special cap. This only fits on anti-theft locking bolts and is not for use with standard wheel nuts.

Anti-theft wheel nuts

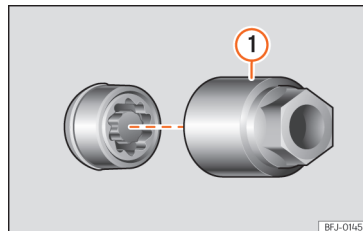


Fig. 35 Anti-theft wheel bolt with cap and adapter.

Loosening the anti-theft wheel bolt

- Remove the wheel cover* or the cap*.
- Insert the special adapter »» Fig. 35 ① (vehicle tools »» page 40) onto the anti-theft wheel bolt and push it on as far as it will go.
- Insert the wheel brace (vehicle tools) onto the adapter as far as it will go.
- Remove the wheel bolt »» page 45.

Note

Make a note of the code number of the anti-theft wheel bolt and keep it in a safe place, but not in your vehicle. If you need a new adapter, you can obtain it from the SEAT Official Service, indicating the code number.

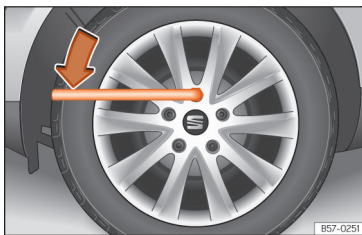
Loosening wheel nuts

Fig. 36 Wheel change: loosen the wheel nuts.

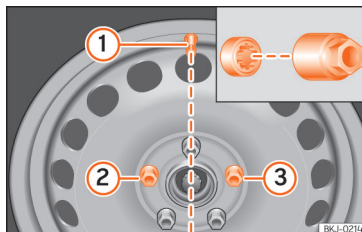


Fig. 37 Wheel change: tyre valve ① and the correct position for the anti-theft wheel locking bolt ② or ③.

Use only the wheel wrench belonging to the car to loosen the wheel nuts.

Loosen the wheel nuts only about one turn before raising the vehicle with the jack.

If the wheel bolt is very tight, carefully push on the end of the wheel wrench with your foot. Hold on to the vehicle for support and take care not to slip during this operation.

Loosening wheel nuts

- Fit the wheel wrench on as far as it will go »» **Fig. 36**.
- Hold the wrench at the end and rotate the bolt approximately one turn anticlockwise »» ⚠.

Important information about wheel nuts

Factory-fitted rims and wheel nuts are specially matched during construction. Therefore, if different rims are fitted, the correct wheel nuts with the right length and heads must be used. This ensures that wheels are fitted securely and that the brake system functions correctly.

In certain circumstances, you should not even use wheel nuts from vehicles of the same model.

In wheels with full hubcaps, the anti-theft locking bolt must be threaded onto positions »» **Fig. 37** ② or ③, taking the tyre valve's position as reference ①. Otherwise it will not be possible to mount the hubcap.

⚠ WARNING

If the wheel nuts are not properly tightened, they could come loose while driving and cause an accident, serious injury and loss of vehicle control.

- Use only wheel nuts which correspond to the rim in question.
- Never use different wheel nuts.
- Wheel nuts and threads should be clean, free of oil and grease, and it should be possible to screw them easily.
- To loosen and tighten wheel nuts, only use the wheel wrench that came with the car from the factory. »»

- The wheel nuts should only be loosened slightly (about one turn) before raising the vehicle with the jack. Risk of accident!
- Never apply grease or oil to wheel nuts or to the wheel hub threads. Even if the bolts have been tightened to the prescribed torque, they could come loose while driving.
- Never loosen the screwed joints of wheel rims with bolted ring trims.
- If wheel nuts are tightened below the prescribed torque, the bolts and rims could come loose while driving. If tightening torque is too high, the wheel nuts or threads can be damaged.

Raise the vehicle

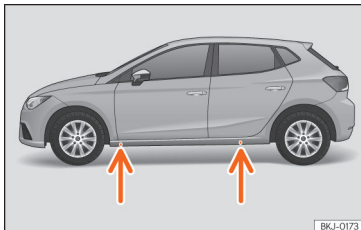


Fig. 38 Jack position points.

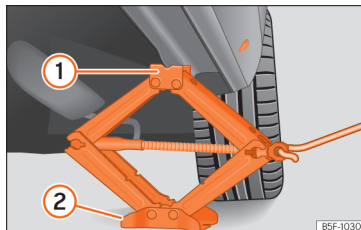


Fig. 39 Cross member: positioning the jack on the vehicle.

- Place the jack* (vehicle tools) on firm ground. If necessary use a large, strong slippery (for example tiles) place the jack on a rubber mat or similar to prevent it from slipping >>> ⚠.
- Find the support point on the strut (sunken area) closest to the wheel to be changed >>> **Fig. 38**.
- Turn the jack* crank handle, located below the strut support point, to raise it until the tab ① >>> **Fig. 39** is below the housing provided.
- Align the jack* so that tab ① "grips" onto the housing provided on the strut and the mobile base ② is resting on the ground. The base plate ② should fall vertically with respect to the support point ①.
- Continue turning the jack* until the wheel is slightly lifted off the ground.

⚠ WARNING

The factory-supplied jack* is only designed for changing wheels on this model. On no account attempt to use it for lifting heavier vehicles or other loads. Risk of injury.

- Make sure that the jack* remains stable. If the surface is slippery or soft, the jack* could slip or sink, respectively, with the resultant risk of injury.
- Only raise the vehicle with the jack* supplied by the manufacturer. Other jacks, even those approved for other SEAT models could slip, with the consequent risk of injury.
- Only mount the jack* on the support points designed for this purpose on the strut, and always align the jack correctly. If you do not, the jack* could slip as it does not have an adequate grip on the vehicle: risk of injury!
- You should never place a body limb such as an arm or leg under a raised vehicle that is solely supported by the jack.
- If you have to work underneath the vehicle, you must use suitable stands additionally to support the vehicle, there is a risk of accident!.
- Never raise the vehicle if it is tilting to one side or the engine is running.
- Never start the engine when the vehicle is raised. The vehicle may come loose from the jack due to the engine vibrations.

ⓘ CAUTION

The vehicle must not be raised on the crossbar. Only place the jack* on the points designed for this purpose on the strut. Otherwise, the vehicle may be damaged.

Removing and installing a wheel

Change the wheel after loosening the wheel nuts and raising the vehicle with the jack.

When removing/fitting the wheel, the rim may hit and damage the brake disc. For this reason, please take care and get a second person to assist you.

Taking off the wheel

- Unscrew the wheel nuts using the box spanner and place them on a clean surface.
- Take off the wheel.

Putting on the spare wheel

Check the direction of rotation of the tyre » page 47.

- Place the spare wheel or temporary spare wheel into position.
- Screw on the wheel nuts in position and tighten them loosely with a box spanner.

- To tighten the anti-theft locking wheel nuts use the corresponding adaptor.
- Carefully lower the vehicle using the jack*.
- Use the wheel spanner to tighten all of the wheel nuts clockwise. Tighten the bolts in diagonal pairs (not in a circle).
- Put the caps, trim or full hubcap back on » page 44.

The wheel nuts should be clean and turn easily. Before fitting the spare wheel, inspect the wheel condition and hub mounting surfaces. These surfaces must be clean before fitting the wheel.

Tightening torque of the wheel nuts

The recommended tightening torque for wheel nuts for steel and alloy wheels is **120 Nm**. After changing a wheel, have the tightening torque checked immediately with a torque wrench that is working perfectly.

Before checking tightening torque, have any rusty wheel nuts that are difficult to screw replaced and clean the wheel hub threads.

Never apply grease or oil to wheel nuts or to the wheel hub threads. Even if the bolts have been tightened to the prescribed torque, they could come loose while driving.

Tyres with directional tread pattern

Tyres with directional tread pattern have been designed to operate best when rotating in only one direction. An arrow on the tyre sidewall indicates the direction of rotation on tyres with directional tread. Always observe the indicated direction of rotation in order to guarantee optimum grip and help avoid aquaplaning, excessive noise and wear.

If the tyre is mounted in the opposite direction of rotation, drive with extreme caution, as the tyre is no longer being used correctly. This is of particular importance when the road surface is wet. Change the tyre as soon as possible or remount it with the correct direction of rotation.

Works after changing a wheel

- *Alloy wheels*: replace the wheel bolt caps.
- *Plate wheels*: replace the wheel hubcap .
- Return all tools to their proper storing location.
- If the replaced wheel does not fit in the spare wheel housing, store it safely in the luggage compartment » page 131.
- Check the tyre pressure of the newly mounted tyre as soon as possible. »

- In vehicles fitted with a tyre pressure indicator, adjust the pressure and store it in memory » page 282.
- Have the tightening torque of the wheel nuts checked as soon as possible with a torque wrench » page 47. Meanwhile, drive carefully.
- Have the flat tyre replaced as quickly as possible.

Changing the windscreen wiper blades

Wiper service position

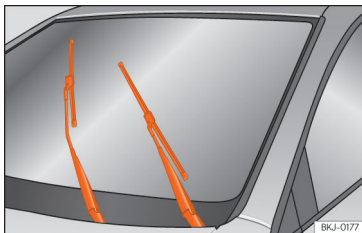


Fig. 40 Wipers in service position.

Ensure that the wiper blades are not frozen.

The wiper arms can be raised when the wipers are in service position » **Fig. 40**.

- Close the bonnet » page 264.
- Switch the ignition on and off.
- Press the windscreen wiper lever downwards briefly » page 122 (4).

Before driving, always lower the wiper arms. Using the windscreen wiper lever, the windscreen wiper arms return to their initial position.

i Note

- The windscreen wiper arms can be moved to the service position only when the bonnet is properly closed.
- You can also use the service position, for example, if you want to fix a cover over the windscreen in the winter to keep it clear of ice.

Changing the wiper rear wiper blades

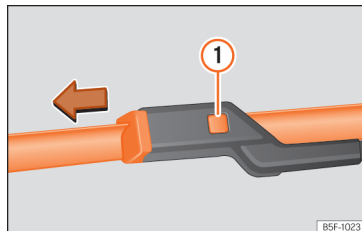


Fig. 41 Changing the windscreen wiper blades

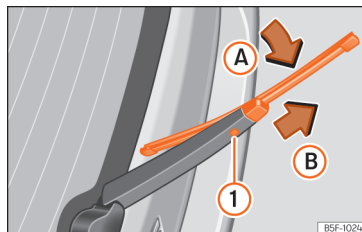


Fig. 42 Changing the rear wiper blade

The windscreen wiper blades are supplied as standard with a layer of graphite. This layer is responsible for ensuring that the wipe is silent. If the graphite layer is damaged, the noise of the water as it is wiped across the windscreen will be louder.

Check the condition of the wiper blades regularly. **If the wipers scrape across the glass**, they should be changed if they are damaged, or cleaned if they are dirty »» ①.

If this does not produce the desired results, the setting angle of the windscreen wiper arms might be incorrect. They should be checked by a specialised workshop and corrected if necessary.

Damaged windscreen wiper blades should be replaced immediately. These are available from qualified workshops.

Raising and lowering windscreen wiper arms

- Place the windscreen wipers in the service position »» page 48.
- Grip the wiper arms **only** by the blade's fastening point.

Cleaning windscreen wiper blades

- Raise the wiper arms.
- Use a soft cloth to remove dust and dirt from the windscreen wiper blades.
- If the blades are very dirty, a sponge or damp cloth may be used »» ①.

Changing the windscreen wiper blades

- Lift and unfold the wiper arms.

- Press and hold release button »» Fig. 41 ① and pull gently on the wiper blade in the direction of the arrow.
- Fit a new wiper blade of the **same length and design** on to the wiper arm and hook it into place.
- Rest the wiper arms back onto the windscreen.

Changing the rear wiper blade

- Lift and fold the wiper arm.
- Turn the blade slightly »» Fig. 42 (arrow A).
- Hold down the release button ① while gently pulling the blade in the direction of arrow B.
- Insert a new blade of the **same length and type** in the rear wiper arm in the opposite direction to the arrow B and hook into place button ①.
- Replace the wiper arm on the rear window.

⚠ WARNING

Worn or dirty windscreen wiper blades reduce visibility and increase the risk of accident and serious injury.

- Always replace damaged or worn windscreen wiper blades or blades that no longer clean the windscreen properly.

ⓘ CAUTION

- Damaged or dirty windscreen wipers could scratch the glass.
- If products containing solvents, rough sponges or sharp objects are used to clean the blades, the graphite layer will be damaged.
- Never use fuel, nail varnish remover, paint thinner or similar products to clean the windows.
- In icy conditions, always check that the wiper blades are not frozen to the glass before using the wipers. In cold weather, it may help to leave the vehicle parked with the wipers in service position »» page 48.

ⓘ CAUTION

- To prevent damage to the bonnet and the wiper arms, **only** leave them in the service position.
- Before driving, always lower the wiper arms.

Jump start

Jump leads

The jump lead must have a sufficient wire cross section. »

If the engine fails to start because of a discharged battery, the battery can be connected to the battery of another vehicle to start the engine.

Jump leads must comply with standard **DIN 72553** [see cable manufacturer's instructions]. The wire cross section must be at least 25 mm² for petrol engines and at least 35 mm² for diesel engines.

i Note

- The vehicles must not touch each other, otherwise electricity could flow as soon as the positive terminals are connected.
- The discharged battery must be properly connected to the on-board network.

Jump start: description

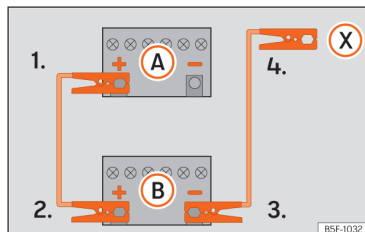


Fig. 43 Diagram of connections for vehicles without Start Stop system

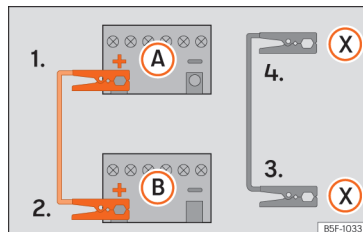


Fig. 44 Diagram of connections for vehicles with Start Stop system

Jump lead terminal connections

1. Switch off the ignition of both vehicles » » » ⚠.
2. Connect one end of the red jump lead to the positive (+) terminal of the vehicle with the flat battery (A) » » » Fig. 43.
3. Connect the other end of the red jump lead to the positive terminal (+) in the vehicle providing assistance (B).
- 3a. *In vehicles without a Start-Stop system:* connect one end of the black jump lead to the negative terminal (-) of the vehicle providing the current (B) » » » Fig. 43.
- 3b. *In vehicles with a Start-stop system:* connect one end of the black jump lead (X) to a suitable ground terminal, to a solid piece of metal in the engine block, or to the engine block itself » » » Fig. 44.

5. Connect the other end of the black jump lead (X) to a solid metal component bolted to the engine block or to the engine block itself of the vehicle with the flat battery. Do not connect it to a point near the battery (A).
6. Position the leads in such a way that they cannot come into contact with any moving parts in the engine compartment.

Starting

7. Start the engine of the vehicle with the boosting battery and let it run at idling speed.
8. Start the engine of the vehicle with the flat battery and wait for 2 or 3 minutes until the engine is running.

Removing the jump leads

9. Before you remove the jump leads, switch off the dipped beam headlights if they are switched on.
10. Turn on the heater blower and heated rear window in the vehicle with the flat battery. This helps minimise voltage peaks which are generated when the leads are disconnected.
11. When the engine is running, disconnect the leads in reverse order to the details given above.

Make sure the battery clamps have sufficient metal-to-metal contact with the battery terminals.

If the engine fails to start after about 10 seconds, switch off the starter and try again after about 1 minute.

WARNING

- Please note the safety warnings referring to working in the engine compartment »» page 264.
- The battery providing assistance must have the same voltage as the flat battery (12V) and approximately the same capacity (see imprint on battery). Failure to comply could result in an explosion.
- Never use jump leads when one of the batteries is frozen. Danger of explosion! Even after the battery has thawed, battery acid could leak and cause chemical burns. If a battery freezes, it should be replaced.
- Keep sparks, flames and lighted cigarettes away from batteries, danger of explosion. Failure to comply could result in an explosion.
- Observe the instructions provided by the manufacturer of the jump leads.
- Do not connect the negative cable from the other vehicle directly to the negative terminal of the flat battery. The gas emitted from the battery could be ignited by sparks. Danger of explosion.

- Never attach the negative cable to fuel system components or the brake lines in the other vehicle.
- The non-insulated parts of the battery clamps must not be allowed to touch. The jump lead attached to the positive battery terminal must not touch metal parts of the vehicle, this can cause a short circuit.
- Position the leads in such a way that they cannot come into contact with any moving parts in the engine compartment.
- Do not lean on the batteries. This could result in chemical burns.

Note

The vehicles must not touch each other, otherwise electricity could flow as soon as the positive terminals are connected.

Tow start and towing

Introduction


Tow-starting means starting the engine of the vehicle while another pulls it.

Towing means one vehicle pulling another that is not roadworthy.

Always consider the legal provisions relating to tow-starting and towing.

For technical reasons, towing a vehicle with a discharged battery is not allowed. The jump start should be used instead »» page 49.

If the vehicle comes with the Keyless Access system, towing is only allowed with the ignition on!

The vehicle battery drains if the vehicle is towed with the engine switched off and the ignition connected. Depending on the battery charge status, the drop in voltage may be so large, even after just a few minutes, that no electrical device in the vehicle may work e.g. the hazard warning lights. In vehicles with the Keyless Access system, the steering wheel could lock »» .

WARNING

A vehicle with no power should never be towed.

- When towing, never remove the ignition key or disconnect the ignition with the start button. Otherwise, the electronic lock of the steering column could suddenly become blocked and it would be impossible to steer the vehicle. This could cause an accident, serious injury and loss of control of the vehicle.
- If during towing the vehicle runs out of power, stop towing immediately and request the assistance of specialist personnel. »

WARNING

Vehicle handling and braking capacity change considerably during towing. Please observe the following instructions to minimise the risk of serious accidents and injury:

- As the driver of the vehicle being towed:
 - You should depress the brake much harder as the brake servo does not operate. Pay the utmost attention to avoid crashing into the towing vehicle.
 - More strength is required at the steering wheel as the power steering does not operate when the engine is switched off.
- As the driver of the towing vehicle:
 - Accelerate with particular care and caution.
 - Avoid sudden braking and manoeuvres.
 - Brake earlier than usual and more smoothly.

CAUTION

- To avoid damaging the vehicle, for example the paint, remove and replace the lid and towing eye carefully.
- Unburnt fuel could enter the catalytic converter and damage it during towing.

Instructions for tow-starting

Vehicle's should not generally be tow-started. The jump start should be used instead »» page 49.

For technical reasons, towing the following vehicles is **not** allowed:

- Vehicles with an automatic gearbox.
- If the vehicle battery is discharged, because in vehicles with the Keyless Access locking and ignition system the steering remains locked and the electronic parking brake cannot be deactivated nor can the electronic lock of the steering column be released if they are activated.
- If the battery is flat, it is possible that the engine control units may not operate correctly.

However, if the vehicle must absolutely be tow-started (in the case of manual gearboxes):

- Engage the 2nd or 3rd gear.
- Keep the clutch pressed down.
- Switch on the ignition and the hazard warning lights of both vehicles.
- Once both vehicles are moving, release the clutch.
- Once the engine starts, press the clutch and disengage the gear to avoid colliding with the towing vehicle.

CAUTION

- When tow-starting, unburnt fuel could enter the catalytic converter and damage it.
- Do not tow a vehicle for more than 50 m in attempt to start it. There is risk of damage to the catalytic converter.

Towing instructions

Towing requires some expertise and experience, especially when using a tow rope. Both drivers should be familiar with the difficulties involved in towing. For this reason, inexperienced drivers should abstain from towing.

During towing, it should be ensured that no impermissible tractive forces or shocks are generated. When towing on an unpaved road, there is always a risk of overloading and damaging the anchorage points.

During towing, the towing vehicle can signal the change of direction even with the hazard warning lights turned on. To do so, at the same time, the turn signal lever must be operated with ignition switched on. Meanwhile, the hazard warning lights will go off. When the turn signal lever is returned to the rest position, the hazard warning lights will be automatically reactivated.

Notes for the driver of the towed vehicle

- Leave the ignition on, so that the steering is not blocked, and the electronic parking brake may be deactivated and the turn signals and wash/wipe operated.
- More strength is required at the steering wheel as the power steering does not operate when the engine is switched off.
- You should depress the brake much harder as the brake servo does not operate. Avoid hitting the towing vehicle.
- Bear in mind the information and instructions in the manual of the vehicle to be towed.

Notes for the driver of the towing vehicle

- Accelerate with particular care and caution. Avoid sharp manoeuvres.
- Brake earlier than usual and smoothly.
- Bear in mind the information and instructions in the manual of the towed vehicle.

Tow rope or tow bar

It is safer for the vehicle to be towed using a tow bar, avoiding damage to the vehicle. A tow rope should only be used if a tow bar is not available.

A tow rope should be slightly elastic to avoid damage to both vehicles. It is advisable to use a tow rope made of synthetic fibre or similarly elastic material.

Only attach the tow rope or the tow bar to the towing eyes provided or a towing bracket.

If the vehicle has a **factory-fitted towing device**, towing with a tow bar is **only** permitted if it has been specially designed to be installed on a tow hitch »» **page 241**.

When the vehicle has to be towed:

Check whether the vehicle may be towed »» **page 53, Cases where towing the vehicle is not permitted**.

The vehicle can be towed using a tow bar or tow rope in the normal way, with all four wheels on the road; it can also be towed with either the front or rear wheels lifted off the road.

- Switch the ignition on.
- Put the gearbox lever in neutral or the selector lever in the **N** »» **page 198** position.
- Do not allow the vehicle to be towed at speeds of over 50 km/h (30 mph).
- The vehicle must not be towed further than 50 km (30 miles).
- If a breakdown lorry is used, vehicles with automatic transmission are only allowed to be towed with the front wheels suspended.

Cases where towing the vehicle is not permitted

- If, due to a fault, the gearbox is out of lubricant.
- If the battery is flat and the steering cannot be unlocked as a result, the electronic steering lock and electronic parking brake cannot be disengaged.
- If a distance above 50 km needs to be travelled.
- When, for example, after an accident, the smooth rotation of the wheels or the steering operation cannot be guaranteed.

When the vehicle is to tow another vehicle:

- Observe legal requirements.
- Keep in mind the instructions in the manual on towing vehicles.

CAUTION

If there is no oil in the gearbox or no lubricant in the automatic transmission the car may only be towed with the driven wheels lifted clear of the road, or transported on a special car transporter or trailer.

Note

The vehicle can only be towed if the steering lock electronic gearbox lock is deactivated. If the vehicle has no power supply or there is an electric system fault, the engine »

must be started using jump leads to deactivate the steering column electronic gear-box lock.

Front towline anchorage

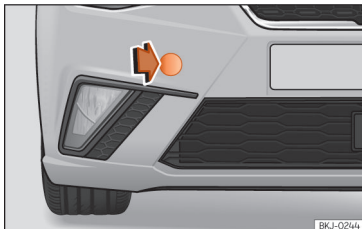


Fig. 45 Right side of the front bumper: remove the cover.

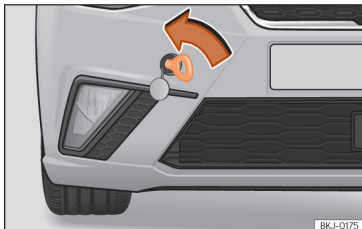


Fig. 46 Right side of the front bumper: towline anchorage in position.

The housing of the removable towline anchorage is on the right side of the front bumper underneath a cover »» Fig. 45.

The towing eye should always be kept in the vehicle.

Bear in mind the instructions for towing »» page 52.

Fitting the towline anchorage

- Remove the towing eye from the vehicle tool kit in the luggage compartment »» page 40.
- Remove the cover by pressing down on its left-hand side and leave it hanging from the vehicle »» Fig. 45.
- Screw the towing eye in the housing by turning it as far as it will go **anticlockwise** »» Fig. 46 »» ⚠. Use a suitable object that can completely and securely tighten the towing eye in its housing.
- After towing, unscrew the towing eye **clockwise** with a suitable object.
- Replace the cover and tighten on its right side until the tab snaps into the bumper.
- Clean the towing eye if necessary and then store it in the luggage compartment along with the other vehicle tools.

⚠ CAUTION

The towing eye must always be completely and firmly tightened. Otherwise, it could be released while towing and tow-starting.

Rear towline anchorage

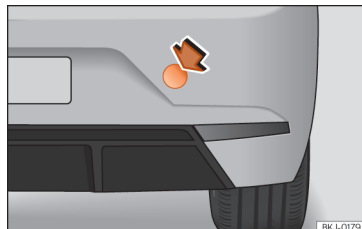


Fig. 47 On the right side of the rear bumper: remove the cover.

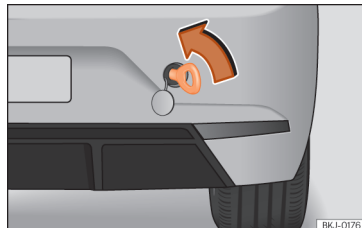



Fig. 48 Right side of the rear bumper: towline anchorage in position.

The housing of the screw towing eye is on the right side of the rear bumper behind a lid »» Fig. 47.

Bear in mind the instructions for towing »» page 52.

Fitting the rear towline anchorage

- Remove the towing eye from the vehicle tool kit in the luggage compartment »» page 40.
- Press the top right hand side of the cover »» Fig. 47 to unclip it.
- Remove the lid and let it hang from the vehicle.
- Screw the towline anchorage into the housing by turning it as far as it will go **anticlockwise** »» Fig. 48 »» . Use a suitable object that can completely and securely tighten the towing eye in its housing.
- After towing, unscrew the towing eye **clockwise** with a suitable object.
- Clean the towing eye if necessary and then store it in the luggage compartment along with the other vehicle tools.

CAUTION

The towing eye must always be completely and firmly tightened. Otherwise, it could be released while towing and tow-starting.

Fuses and bulbs

Fuses

Introduction

In general, a fuse can be assigned to various electrical components. Likewise, an electrical component can be protected by several fuses.

Only replace fuses when the cause of the problem has been solved. If a newly inserted fuse blows after a short time, you must have the electrical system checked by a specialised workshop as soon as possible.

WARNING

The high voltages in the electrical system can give serious electrical shocks, causing burns and even death!

- Never touch the electrical wiring of the ignition system.
- Take care not to cause short circuits in the electrical system.

WARNING

Using unsuitable fuses, repairing fuses or bridging a current circuit without fuses can cause a fire and serious injury.

- Never use a fuse with a higher value. Only replace fuses with a fuse of the same am-

perage (same colour and markings) and size.

- Never replace a fuse by a metal strip, staple or similar.

CAUTION

- To prevent damage to the vehicle's electric system, before replacing a fuse always turn off the ignition, the lights and all electrical elements and remove the key from the ignition.
- Protect the fuse boxes when open to prevent the entry of dust or humidity as they can damage the electrical system.

Note

- One component may have more than one fuse.
- Several components may run on a single fuse.
- In the vehicle, there are more fuses than those indicated in this chapter.

Fuses inside the vehicle

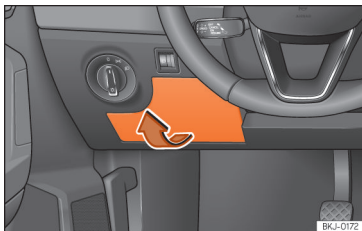


Fig. 49 On the driver's side dashboard: fuse box cover.

Opening and closing the fuse box situated below the dash panel

- Open: remove the fuse box cover in the direction indicated »» Fig. 49.
- Close: click the cover back into place.

Identifying fuses below the dashboard by colours

Colour	Amp rating
Black	1
Purple	3
Light brown	5
Brown	7.5
Red	10

Colour	Amp rating
Blue	15
Yellow	20
White or transparent	25
Green	30
Orange	40

ⓘ CAUTION

- Always carefully remove the fuse box covers and refit them correctly to avoid problems with your vehicle.
- Protect the fuse boxes when open to avoid the entry of dust or humidity. Dirt and humidity inside fuse boxes can cause damage to the electrical system.

Fuses in the engine compartment

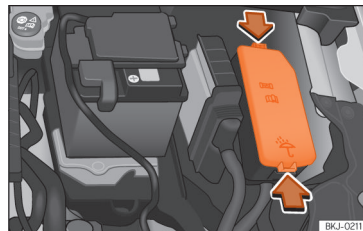


Fig. 50 In the engine compartment: fuse box cover.

To open the engine compartment fuse box

- Open the bonnet ⚠ »» page 264.
- Press the locking tabs to release the fuse box cover »» Fig. 50.
- Then lift the cover out.
- To fit the cover, place it on the fuse box. Push the locking tabs down until they click audibly into place.

Replace a blown fuse

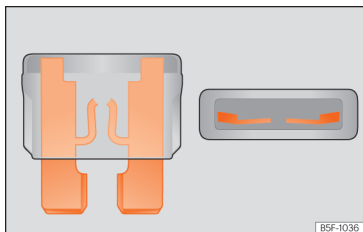


Fig. 51 Image of a blown fuse.

Preparations

- Switch off the ignition, lights and all electrical equipment.
- Open the corresponding fuse box
» page 56, » page 56.

Recognise a blown fuse

A fuse is blown if its metal strip is ruptured
» **Fig. 51**.

- Point a lamp at the fuse to see if it has blown.

To replace a fuse

- Remove the fuse.
- Replace the blown fuse by one with an identical amperage rating (same colour and markings) and identical size.

- Replace the cover again or close the fuse box lid.

Fuse placement

Only replace fuses with a fuse of the same amperage (same colour and markings) and size.

Fuses in the vehicle interior

No.	Consumer/Amps	
1	Tow hook	20
3	Sound amplifier	30
4	Cigarette lighter/12V power point	20
5	Panoramic roof	30
6	Central locking	40
8	Heating fan/Climatronic	30
10	Tow hook	25
11	CNG Gauge	7.5
13	Lights switch, steering column LSS and SMLS, diagnostic port, rain/light sensor	7.5
14	Steering Column LSS: wiper control	10
15	Kombi, Emergency call (+ NZ4)	7.5
16	Right lights power supply	40
17	Right Door Window Control	30

No.	Consumer/Amps	
18	Windscreen wipers	30
19	Radio, Multimedia System	25
20	Heated rear window	30
21	SCR Control Unit	30
23	Rear View Camera	7.5
24	Connectivity Box, connection for external audio sources (Double USB), MIB display	5
25	Steering column electronics (MFL)	7.5
26	Gateway	7.5
27	Active suspension control unit	7.5
28	DWA Sensor	7.5
29	DWA Horn	7.5
31	9AA/9AB climate control unit	7.5
	9AK Climatronic control unit	15
32	Steering Column LSS, without Kessy	7.5
33	Left Door Window Control	30
35	Left lights power supply	40
36	Signal Horn	20
37	Heated seats control unit	30
38	BCM Power C63	30
39	BSD, PDC, MRR, PLA	10

»

Emergencies

No.	Consumer/Amps	
40	Light switch, diagnosis input, head-lamp range regulator, LSS steering column: lamps, halogen lamps, switch, reverse gear, electrochromic mirror, RKA without radio.	7.5
41	Regulation of unfolded exterior mirrors,	7.5
42	Clutch pedal, ignition relays, CNG relay coil, AC pressure sensor	7.5
43	DWP relay coil, rear window wiper motor	15
44	Airbag	7.5
45	Left full LED headlight	7.5
46	Right full LED headlight	7.5
48	Steering column lock, Kessy Control Unit	7.5
49	SCR relay	7.5
53	Automatic gearbox lever, ZSS	7.5
58	Windscreen washer pump	7.5
59	Heated rear view mirrors	10
60	Tow hook	30
61	Tow hook	30

Fuse arrangement in engine compartment

No.	Consumer/Amps	
1	MPI Engine Injection Module	10
	TSI Engine Injection Module	15
	Diesel Engine Injection Module	30
2	Fuel metering valve (TJ4/T6P/TJ7), Low temperature coolant pump (TJ4/T6P/TJ7); Oil pressure regulating valve (TJ1), AGR coolant valve (TJ1), High and low pressure water pumps (TJ1), SCR relay coil, cylinder head water valve	7.5
	Lambda probes	15
4	Engine petrol pump relay (MPI), Gauge control unit (TSI and diesel)	15
5	Electric fan (EC), LDR valve, canister and variable distribution valve, oil pressure regulating valve, cylinder disconnection valves, WIV sensor and CNG pressure regulator	10
6	Spark plugs (MPI and TSI)	20
	Glow plug relay, Suction hose resistor (diesel)	7.5
7	Vacuum pump (TSI, CNG)	15
8	Injectors and EKP relay coil (MPI), Fuel metering valve (diesel)	10
9	Servo sensor	7.5

No.	Consumer/Amps	
10	Vref Battery: Gateway, BDM and BCM	7.5
12	Detachable compressor	10
14	ESC/ABS, PTC diesel relay and engine controller (TJ1/TJ4/TH4/T5I/TJ7/TC5/Y5Y)	7.5
15	Automatic gearbox DQ200 and AQ160	30
17	50 Diag	7.5
18	BDM starter motor	30
20	ESC (Pump)	60
	ABS (Pump)	40
21	ESC/ABS (Valves)	25
24	TH4 Electric fan without A/C for moderate climate countries	30
25	TH4 fan with A/C or T5I for moderate climate countries	20
	PTC1	40
26	TJ1/TJ4/TJ7/T6P or TH4/T5I Electric fan for warm climate countries	50
27	TH4 fan with A/C or T5I for moderate climate countries	30
	PTC2	40
28	PTC3	40

i Note

- In the vehicle, there are more fuses than those indicated in this chapter. These should only be changed by a specialised workshop.
- Positions not containing a fuse do not appear in the following tables.
- Some of the equipment listed in the tables below pertain only to certain versions of the model or are optional extras.
- Please note that the above lists, while correct at the time of printing, are subject to change.

Changing bulbs

Introduction

Changing bulbs requires a certain degree of practical skill. If you are unsure, SEAT recommends that you consult a technical service or request assistance from a specialist. In general a specialist is needed if, in addition to the bulbs, other vehicle components require removal.

If you choose to change the engine compartment lamps yourself, remember that it is a dangerous area » » **⚠ in Working in the engine compartment on page 264.**

Always use identical bulbs with the same designation. The name can be found on the base of the bulb holder.

Depending on how equipped the vehicle is, there are different sets of headlights and tail lights:

- Halogen headlights.
- Full-LED main headlights*
- Halogen headlights with LED daytime running lights*
- Rear bulb light
- LED rear light*

Full-LED headlight system*

Full-LED headlights handle all light functions (daylight, side light, turn signal, dipped beam and route light) with light emitting diodes (LEDs) as a light source.

Full-LED headlights are designed to last the lifetime of the car and light bulbs cannot be replaced. In case of headlight failure, go to an authorised workshop to have it replaced.

Bulbs (12 V)

Depending on the level of equipment fitted in the vehicle, LEDs may be used for part or all of the interior and/or exterior lighting. LEDs have an estimated life that exceeds that of the vehicle. If an LED light fails, go to an authorised workshop for its replacement.

Light source used for each function

Halogen headlights.	Type
Dipped beam headlights	H7
Main beam headlights	H7
Side light/DRL (daytime running light)	W21W
Turn signal	PY 21W

Halogen headlight with LED DRL	Type
Dipped beam headlights	H7
Main beam headlights	H7
Turn signal	PY 21W
Side light/DRL (daytime running light)	LED ^{a)}

^{a)} In case of a LED failure, go to an authorised workshop to have it replaced.

Full-LED main headlights	Type
No bulbs may be replaced. All functions are with LEDs. In case of a LED failure, go to an authorised workshop to have it replaced.	

»

Bulb light	Left	Right
Brake lights	2 x P21WLL	2 x P21WLL
Side lights		
Retro fog light	W21W	-
Reverse light	-	W16W
Turn signal	PY 21W NA LL	PY 21W NA LL

Light with LEDs	Left	Right
Brake lights	LED	LED
Side lights	LED	LED
Retro fog light	LED	-
Reverse light	-	W16W
Turn signal	PY 21W NA LL	PY 21W NA LL

⚠ WARNING

- Take particular care when working on components in the engine compartment if the engine is warm. Risk of burns.
- Bulbs are highly sensitive to pressure. The glass can break when you touch the bulb, causing injury.
- When changing bulbs, please take care not to injure yourself on sharp edges, in particular on the headlight housing.

⚠ CAUTION

- Remove the ignition key before working on the electric system. Otherwise, a short circuit could occur.
- Switch off the lights and the parking light before changing a bulb.
- Take good care to avoid damaging any components.

♻ For the sake of the environment

Please ask your specialist retailer how to dispose of used bulbs in the proper manner.

i Note

- Depending on weather conditions (cold or wet), the front lights, the fog lights, the tail lights and the turn signals may be temporarily misted. This has no influence on the useful life of the lighting system. By switching on the lights, the area through which the beam of light is projected will quickly be demisted. However, the edges may continue to be misted.
- Please check at regular intervals that all lighting (especially the exterior lighting) on your vehicle is functioning properly. This is not only in the interest of your own safety, but also that of all other road users.
- Before changing a bulb, make sure you have the correct new bulb.
- Do not touch the glass part of the bulb with your bare hands, use a cloth or paper

towel instead, since the fingerprints left on the glass will vaporise as a result of the heat generated by the bulb, they will be deposited on the reflector and will impair its surface.

- Depending on the level of equipment fitted in the vehicle, LEDs may be used for part or all of the interior and/or exterior lighting. LEDs have an estimated life that exceeds that of the car. If an LED light fails, go to an authorised workshop for its replacement.

Main beam headlight bulb

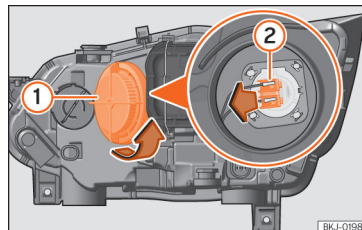


Fig. 52 In the engine compartment: main beam headlight bulb.

- Raise the bonnet.
- Turn the cover ① anti-clockwise and take it out >>> **Fig. 52**.

- Remove the bulb connector ② by pulling it outwards.
- Remove the bulb by pulling it out and fit the new one.
- Fit the bulb connector ②.
- Fit cover ①, turning it towards the right.
- Check whether the new bulb is working.

Dipped beam headlight bulb

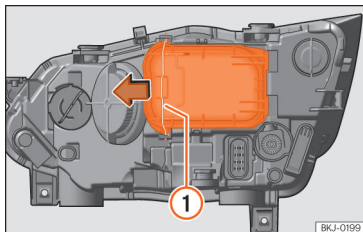


Fig. 53 In the engine compartment: remove the cover.

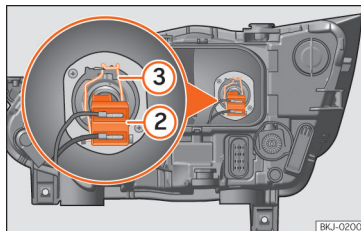


Fig. 54 In the engine compartment: dipped beam headlight bulb.

- Raise the bonnet.
- Move the loop »» Fig. 53 ① in the direction of the arrow and remove the cover.
- Remove the bulb connector »» Fig. 54 ②.
- Unclip the retainer spring »» Fig. 54 ③ pressing inwards to the right.
- Extract the bulb and fit the replacement so that the lug on the base fits into the recess on the reflector.
- Fit the connector.

- Fit the cover and close the strap. Make sure that the gasket sits well on the casing cover during the operation.
- Check whether the new bulb is working.

Turn signal and DRL/side light (daytime running light)¹⁾

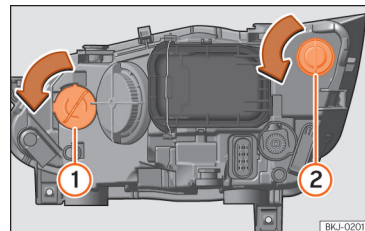


Fig. 55 In the engine compartment: turn signal light bulb ① and DRL (daytime running light) bulb ②.

- Raise the bonnet.
- Turn the bulb holder »» Fig. 55 ① or ② to the left and pull.

¹⁾ In headlight versions with LED DRL, this light source cannot be replaced. It is designed to last the length of the vehicle's service life. In case of failure, go to an authorised workshop to have it replaced.

- Remove the bulb by pressing on the bulb holder and turning it anticlockwise at the same time.
- Installation involves all of the above steps in reverse sequence.

Front fog light bulb

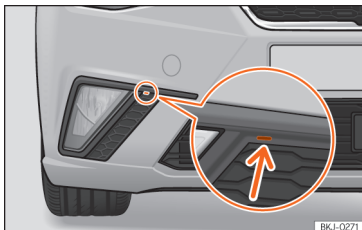


Fig. 56 Front fog light: remove the grille

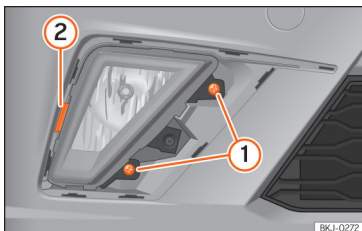


Fig. 57 Front fog light: remove the bulb holder

Follow the steps indicated:

- Lever the groove with a screwdriver » **Fig. 56** (arrow). Next, remove the clips located on the edge of the grill, levering them gently.
- Remove the two bolts » **Fig. 57** ① and lever the clip ② to remove the front fog light.
- Remove the bulb connector.
- Turn the bulb holder to the left and pull.
- Remove the bulb by pressing on it and turning it anticlockwise at the same time.
- Replace the bulb, making sure that the fixing guides are in the right position and then press it and turn it clockwise
- To install the headlight go back through the above steps in reverse.
- Check that the bulb works properly.

Tail light bulbs

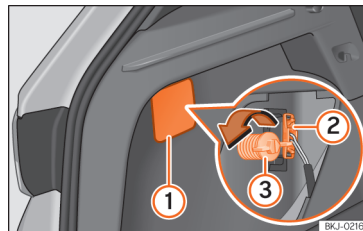


Fig. 58 Luggage compartment: access to the bolt securing the tail light unit.

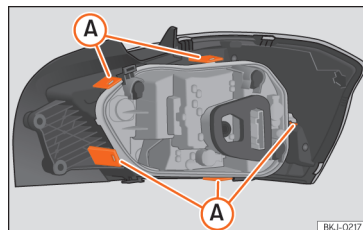


Fig. 59 Retaining tabs on reverse side of tail light.

Follow the steps indicated:

- Check which of the bulbs is defective.
- Open the rear lid.

- Remove the lid, levering the flat side of a screwdriver into the recess »» Fig. 58 ①.
- Remove the bulb connector ②.
- Unscrew the light securing bolt ③ by hand or using a screwdriver.
- Remove the light from the body, gently pulling it toward you, and place on a clean, smooth surface.
- Remove the bulb holder unlocking the retaining tabs »» Fig. 59 A).
- Change the damaged bulb.
- To refit follow the steps in reverse order, taking special care when fitting the bulb holder. The securing tabs must click into place.

ⓘ CAUTION

Take care when removing the rear light unit to make sure there is no damage to the paintwork or any of its components.

ⓘ Note

- Make sure you have a soft cloth ready to place under the glass on the rear light unit, to avoid any scratches.
- For LED lights, you can only change the turn signal and reverse light bulbs.

Number plate light

- Insert the flat part of a screwdriver into the special slot and remove the bulb.
- Remove the bulb holder, by turning it until it is free.
- Change the bulb.
- Replace the bulb holder, by turning it until it fits fully.
- Fit the light into the space and press until you hear a “click”.

ⓘ Note

Depending on how equipped the vehicle is, the number plate lights may be LEDs. LEDs have an estimated life that exceeds that of the car. If a light with LEDs fails, go to an authorised workshop for replacement.

Side turn signals

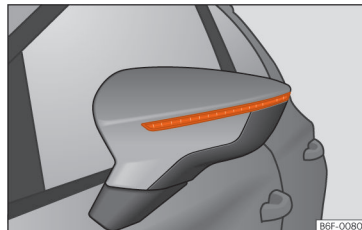


Fig. 60 Turn signal integrated in the rear view mirror

The side turn signals are LEDs and are integrated in the rear view mirrors.

In case of failure, go to an authorised workshop to have it replaced.

Additional brake light

Taking into account that it consists of LED bulbs, the change should be made at a technical service centre.

Interior light and front reading lights

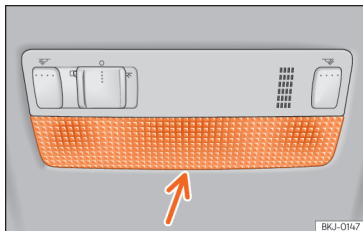


Fig. 61 Front reading light.

To remove the glass

- Insert a fine screwdriver between the casing and the glass »» **Fig. 61**.
- Carefully remove the glass, levering it to avoid possible damage.

To replace the bulbs

- Pull the bulbs outwards.
- To remove the central bulb, hold and press to one side.

Assembly

- Proceed in the reverse order, pressing gently on the outer edge of the side light.
- First fit the glass with the fastening tabs over the frame of the switch. Next press the

front part until the two long tabs click on the support.

i Note

In LED courtesy lights it is not possible to replace the light sources. If the light does not work, take the vehicle to an official Service.

Luggage compartment lighting*

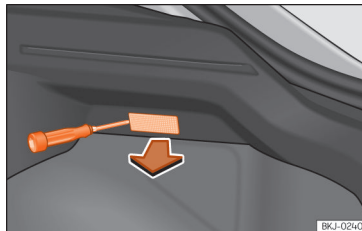


Fig. 62 Boot light.

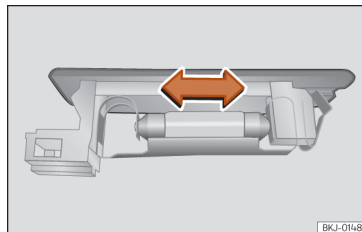


Fig. 63 Boot light.

- Extract the bulb by pressing on its inside edge using the flat side of a screwdriver »» **Fig. 62**.
- Disconnect the cable.
- Press the bulb sideways and remove it from its housing »» **Fig. 63**.
- Change the bulb.
- Connect the cable again.
- Refit the bulb and press it in until it engages.

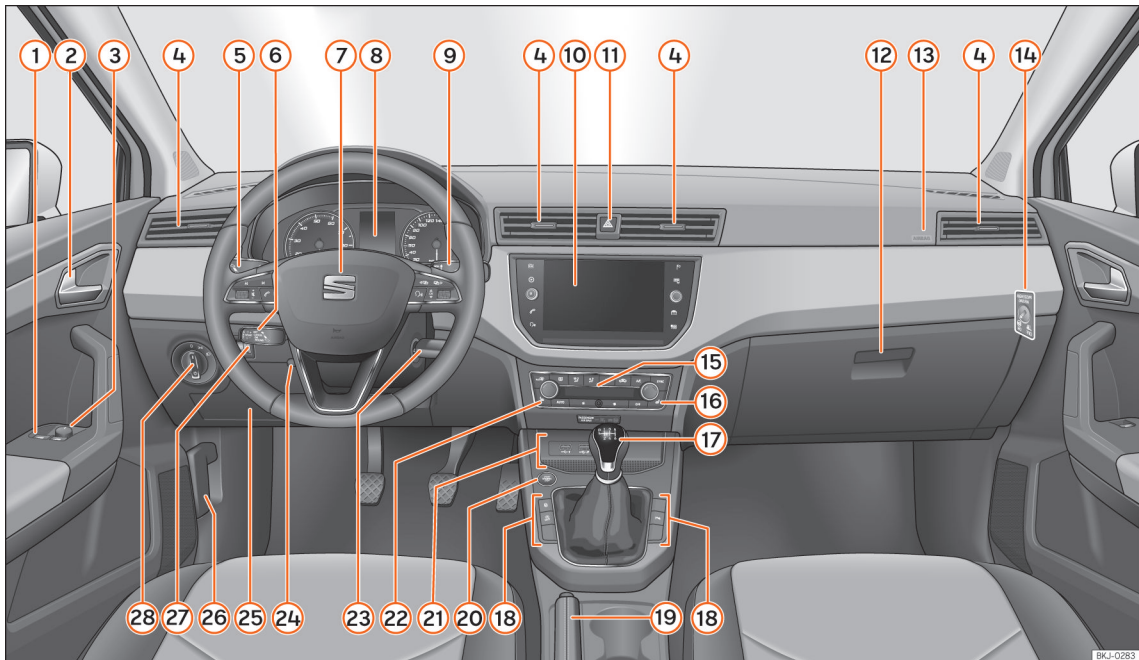


Fig. 64 Instruments and controls.

BKJ-0283

Operation

Controls and displays

Interior view

Overview

① Electric window controls	110	– Paddle levers for tiptronic gearshift (automatic gearbox)	201	⑱ Depending on the equipment, buttons for:	
② Interior door handle		⑧ Instrument panel and warning lamps:		– Central locking*	101
③ Control for adjusting electric exterior mirrors	125	– Instruments	68	– Start-Stop operation button	196
④ Air vents		– Control and warning lamps	84	– SEAT Drive Profile	207
⑤ Lever for:		⑨ Lever for:		– Parking and manoeuvring aid systems	234
– Turn signals/main beam headlights	117	– Windscreen wipers and washer ...	122	– Tyre pressure monitoring*	282
– Cruise control system (GRA) and speed limiter*	213, 216	– Wipe and wash system*	122	⑲ Handbrake lever	230
⑥ According to features, lever for:		– Multi-function display control* ...	74	⑳ Start-up push button (Keyless Access closing and start-up system)	192
– Cruise control system (CCS)	213	⑩ Infotainment system:		㉑ Depending on the equipment:	
– Speed limiter	216	⑪ Hazard warning lights	119	– USB port	190
– Adaptive Cruise Control (ACC) ...	222	⑫ Depending on the equipment, glove compartment with:	137	– Connectivity Box/Wireless Charger*	189
⑦ Steering wheel with horn and		– CD player* and/or SD card*		㉒ Driver's seat heating control*	145
– Driver airbag	22	⑬ Front passenger airbag*	25	㉓ Ignition lock (vehicles without Keyless Access)	191
– On-board computer controls	82	⑭ Front passenger airbag disconnection switch*	26	㉔ Steering column adjustment lever	15
– Controls for radio, telephone, navigation and speech dialogue system	91	⑮ Switches for:		– Fuse housing	55
		– Heating and ventilation	142	㉕ Lever for unlocking the bonnet	265
		– Air conditioning*	142	㉖ Light range control*	121
		– Climatronic*	141	㉗ Light switch	115 »
		⑯ Front passenger seat heating control*	145		
		⑰ Gear lever			
		– Manual gearbox	198		
		– Automatic gearbox	199		

i Note

- Some of the equipment listed in this section is only fitted on certain models or are optional extras.
- The arrangement of switches and controls on right-hand drive models* may be slightly different from the layout shown in »» page 66. However, the symbols used to identify the controls are the same.

Instruments and warning/control lamps

Instrument panel

Introduction

The vehicle can be fitted with a instrument panel digital lap timer or one Digital (SEAT Cockpit).

After switching the engine on with a 12-volt battery that is heavily discharged or newly changed some system settings (such as the time, the date, the personalised comfort set-

tings and the programming) might be altered or deleted. Check and correct these settings once the battery is sufficiently charged.

⚠ WARNING

Any distraction may lead to an accident, with the risk of injury.

- Do not operate the instrument panel controls when driving.
- To reduce the risk of accident and injury, only make adjustments to the instructions on the screen of the instrument panel and to the instructions on the screen of the Infotainment system when the vehicle is stationary.

Analogue instrument panel

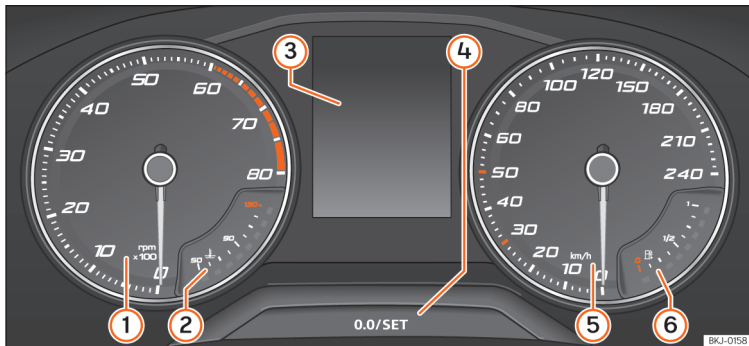


Fig. 65 Monochrome instrument cluster on the dash panel.

Details of the instruments » **Fig. 65:**

① **Revolution counter** (with the engine running, in hundreds of revolutions per minute) » page 78.

② **Engine coolant temperature display** » page 80 or **natural gas gauge** in vehicles with natural gas engine (CNG) » page 79

③ **Displays on the screen** » page 71.

④ **Adjuster button and display.**

⑤ **Speedometer.**

⑥ **Fuel gauge** » page 78.

Digital dashboard (SEAT Digital Cockpit)

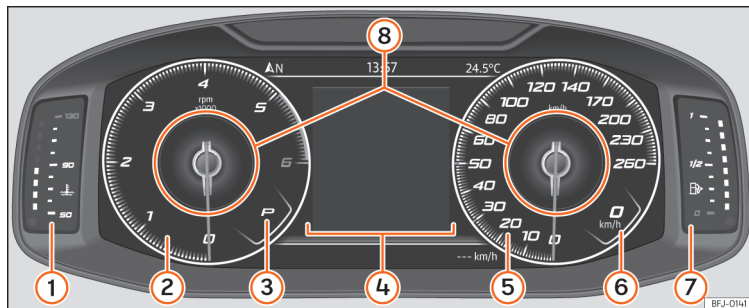


Fig. 66 SEAT Digital Cockpit on the instrument panel (classic view).

Details of the instruments:

- ① **Engine coolant temperature display**
» page 80
- ② **Revolution counter.** Revolutions per minute the engine is running » page 78.
- ③ **Gear engaged or position of the selector lever currently selected**
- ④ **Screen display** » page 71
- ⑤ **Speedometer**
- ⑥ **Digital speed display**
- ⑦ **Fuel gauge** » page 78.
- ⑧ **Information Profile** » page 70.

The Digital SEAT Cockpit is an instrument panel digital with monochrome screen in colour high resolution. It has a 3 views accessible using the button **VIEW** of the multifunction steering wheel. By selecting different information other than the classic circular instruments can be displayed, such as navigation data, multimedia information or travel data.

The 3 views are:

- Classic
- Dynamic
- Navigation (without information profiles)

All views will display information on the screen about audio, phone, travel data, vehicle status, navigation¹⁾ and driving aids¹⁾.

In the **Classic** and **Navigation** views it is possible to customise the information displayed under **Information profiles** » **Fig. 66 ⑧**.

Information profiles

The **INSTRUMENT CLUSTER** options (infotainment button **CAR / ⓘ > View > Instrument cluster**) can be used to choose between the different options for displaying information in the SEAT Digital Cockpit.

¹⁾ Depending on the version.

Classic View

The revolutions per minute and speedometer needles appear along the entire length
»» Fig. 66.

View 1, 2, 3 or AUTOMATIC*¹⁾

Personalisation of the information that appears in the Digital SEAT Cockpit. Only 2 of these items of information can be displayed at the same time, but the user chooses which to display, and in what order, by moving the finger vertically over the dials.

Depending on the version, the Views can be memorised by exiting the menu or keeping the **View** button pressed.

- **Consumption.** Graphic representation of the current consumption and digital display of the average consumption.

- **Audio.** Digital display of the current audio playback.

- **Altitude.** Digital display of the current altitude above sea level.

- **Compass.** Digital display of the compass.

- **Information about the final destination.** Digital display of the remaining travelling time, distance to the destination and the estimated time of arrival.

- **Operating range.** Digital display of the remaining range.

- **Travel time.**

- **Route guidance.**

- **Journey.** Digital display of the distance travelled.

- **Assistance systems.** Graphic representation of different assistance systems.

- **Traffic signs.** Display of traffic signs detected.

- **Navigation.** Graphical representation of the navigation with arrows.

It may vary based on the features, the number and the contents of the selectable information profiles..

Navigation map in the SEAT Digital Cockpit*

Depending on the features, the SEAT Digital Cockpit can display a detailed map. To do this, select the **Navigation** option in the menu menu on the instrument panel
»» page 73.

Depending on the features or the navigation map, it can be shown in the Digital SEAT

Cockpit or on the Infotainment system or on both at the same time. If it is displayed only in the Infotainment system, the SEAT Digital Cockpit will only display the arrows for manoeuvres.

Transfer of navigation map

The map is transferred from the Infotainment system to the Digital SEAT Cockpit and vice versa using the map transfer key.

Using the right thumbwheel of the multifunction steering wheel, in the **Navigation** menu, you can transfer the map back to the Infotainment System.


Status display

Possible indications on the instrument panel display

Different pieces of information can be displayed on the screen of the instrument panel, depending on the features of the vehicle.

- Doors, bonnet and rear lid open
- Warning and information messages
- Odometer
- Time »» page 77

¹⁾ Pre-set information depending on the selected "Driving mode".

- Radio, media and navigation system indications
- Indications of the phone
- Outside temperature
- Indications of the compass
- Selector lever positions
- Gear-change recommendation
»» page 205
- Display of travel data (multifunction display) and menus for different settings
»» page 73
- Service interval display »» page 81
- Speed warning »» page 74
- Speed warning for winter tyres
- Start-Stop system status display
»» page 196
- Active cylinder management (ACT®) status indication »» page 209
- Low consumption driving 
- Identifying letters on engine (LDM)
- Driver assistance system display
»» page 211
- Copyright

Doors, bonnet and rear lid open


When the vehicle is unlocked and while driving, the instrument panel display shows if any of the doors, the bonnet or rear lid are opened and, in some cases, it is also indica-

ted by an audible warning. The display may vary according to the type of instrument panel fitted.

Selector lever positions (DSG® dual clutch gearbox)

The current position of the selector lever is shown on the side of the lever and on the instrument panel display. When the lever is in the **D/S** position or in the Tiptronic position, in some cases, the gear engaged in each case is shown on the instrument panel display.

Outside temperature indicator

If the outside temperature is lower than approximately +4 °C [+39 °F], the "ice crystal symbol" ❄ on the outside temperature display also lights up. This symbol remains lit until the outside temperature exceeds +6 °C [+43 °F] »» .

When the vehicle is stationary, when the auxiliary heater is switched on or when driving at very low speeds, the outside temperature indicated may be higher than the actual temperature due to the heat produced by the engine.

The margin of measurement ranges from -45 °C [-49 °F] to +76 °C [+169 °F].

Gear-change recommendation





While driving, the instrument panel of certain vehicles may indicate a gear recommendation for saving fuel »» page 205.

Odometer

The *odometer* registers the total distance travelled by the car.

The *partial odometer (trip)* shows the distance travelled since the last time it was reset to zero.

Vehicles with analogue instrument panel:


- Briefly press the button  »» Fig. 65 
- Keep the button   pressed for about 3 seconds and the previous value will be displayed.

Vehicles with digital instrument panel:

- Set the odometer to zero via the Infotainment system or the multifunction steering wheel »» page 74.

Speed warning for winter tyres

If the maximum speed set is exceeded, this is displayed on the instrument panel
»» page 73.


The speed warning can be set up on the Infotainment system, using the infotainment button **CAR** /  > **SETTINGS** > **Driver assistance** »» page 90.

Indications of the compass

Depending on the equipment, when the ignition is on, the instrument panel display indicates the direction in which you are driving with a symbol, e.g. NW for Northwest.



When the Infotainment system is on and there is no route guidance active, the graphic representation of a compass is also shown.

Low consumption driving *

Depending on the equipment, when the vehicle is moving  is displayed on the instrument cluster display when the vehicle is in an economical consumption status due to active cylinder management (ACT®)* »» page 209.

Identifying letters on engine (LDM)

Vehicles with analogue instrument panel:

- Switch the ignition on, but do not start the engine.
- Hold the button  »» Fig. 65  down for more than 15 seconds to display the identifying letters of the vehicle engine (MKB).

Copyright

Legal text about the property rights and copyrights of the instrument cluster.

WARNING

Even when the outside temperature is higher than freezing temperature, some roads and bridges could be frozen.

- The “ice crystal symbol” indicates that there may be a risk of freezing.
- At outside temperatures above +4 °C (+39 °F), there may be ice even when the “ice crystal symbol” is not on.
- The outside temperature sensor takes a guideline measurement.

Note

- There are different instrument panels and therefore the versions and instructions on the display may vary. In the case of displays without warning or information texts, faults are indicated exclusively by the control warning lamps.
- Some indications on the instrument panel screen may be concealed by a sudden event, e.g. an incoming call.
- Depending on the equipment, some settings and instructions can be carried out or displayed on the infotainment system as well.
- If there are several warnings at the same time, the symbols will be displayed one after the other for a few seconds. The symbols will stay on until you remove the cause.

- If when switching on the ignition warnings are shown about existing faults, it might not be possible to change the settings or show the information as described. In this case, go to a specialised workshop and request a repair.

Instrument panel menus

The number of menus and information items available will depend on the vehicle's electronics and features.

A specialised workshop can programme or modify additional functions, according to the vehicle equipment. SEAT recommends visiting a SEAT dealership for this.

Some menu options can only be read when the vehicle is stationary.

- **Driving data** »» page 74
- **Assistance systems**
 - Front Assist On/Off »» page 219
 - ACC (only display) »» page 222
- **Navigation**
- **Audio**
- **Telephone**
- **Vehicle status** »» page 75

Service Menu

✓ Applies to vehicles with Active Info Display (Digital SEAT Cockpit)

In the Service menu various settings can be adjusted depending on the features.

Open the Service menu

To open up the **Service** menu, select the **Range** information profile while in the **Driving data** menu, and keep the **OK** key pressed on the multifunction steering wheel for approximately 4 seconds. When it is released, the **Service** menu will be displayed. Now you can browse through the menu using the keys on the multifunction steering wheel as usual.

Restart the service interval display

Select the **Service** menu and follow the instructions on the screen of the instrument panel.

Restart the oil service

Select the **Restore Oil service** menu and follow the instructions on the instrument panel display.

Restart journey data

Select the **Reset trip** menu and follow the instructions on the instrument panel display to reset the value.

Identifying letters on engine (LDM)

Select the menu **Engine code**. The identifying letters of the engine will be shown on the instrument cluster display at the bottom left.

Setting the clock

Select the **Time** menu and set the correct time by turning the right thumbwheel of the multifunction steering wheel.

Driving data indicator (multifunction display)

The display of the travel data (multifunction display) shows different values about the journey and the consumption.

Change from one display to another

Vehicles without multifunction steering wheel:

- Press the rocker switch **TRIP** on the wiper lever » page 83.

Vehicles with multifunction steering wheel:

- Turn the right thumbwheel of the multifunction steering wheel » page 83.

Changing memory

Vehicles with analogue instrument panel:

- Press the **OK/RESET** button on the windscreen wiper lever or the **OK** button of the multifunction steering wheel.

Vehicles with digital instrument panel:

- While in **Travel data > General information** press **OK** on the multi-function steering wheel to switch between the 3 memories¹⁾:

- **Since start:** The memory is deleted if the journey is interrupted for more than 2 hours.
- **Since refuelling:** Display and storage of the journey data and the consumption values collected. When refuelling, the memory is deleted.
- **Long-term:** This memory contains travel data up to a maximum of 19 hours and 59 minutes or 99 hours and 59 minutes, or up to a maximum of 1999.9 km or 9999.9 km. When one of these values is

¹⁾ This will show all data on the display at the same time: distance travelled, average consumption, average speed and autonomy.

exceeded (varies depending on the version of the instrument panel), the memory is deleted.

Delete journey data presets

- Select the memory that you wish to erase.
- Hold the **OK/RESET** button of the multifunction steering wheel or the **OK** button of the multifunction wheel pressed down for about 2 seconds.

Select the instructions

In the Infotainment system, in the menu Vehicle settings, you can display different travel data »» page 86.

- **Current consumption:** The current fuel consumption display operates throughout the journey, in litres/100 km; and with the engine running and the vehicle stopped, in litres/hour.
- **Average consumption:** The average fuel consumption is displayed after driving for approximately 300 metres.
- **Travelling time:** This indicates the hours (h) and minutes (min) since the ignition was switched on.
- **Range:** Approximate distance in km that can still be travelled if the same driving style is maintained.

- **AdBlue range or ρ :** Approximate distance in km that can still be travelled with the current level of the AdBlue® tank with the same driving style. The indication appears from a range of less than 2,400 km and cannot be deactivated.¹⁾
- **Distance:** Distance covered in km (m) after switching on the ignition.
- **Average speed:** The average speed will be shown after driving for approximately 100 metres.
- **Digital speed display:** Current speed displayed in digital format.



Setting a speed warning

- Select the display **Warning at --- km/h** or **Speed warning at --- mph**.
- Press the button **OK/RESET** on the windscreen wiper lever or the button **OK** on the multifunction steering wheel to store the current speed and activate the warning.
- *Activate:* adjust to the desired speed within 5 seconds using the rocker switch **TRIP** on the windscreen wiper lever or by turning the thumbwheel on the multifunction steering wheel. Next, press the button **OK/RESET** or **OK** again or wait several seconds. The speed is stored and the warning activated.

- *Deactivate:* press button **OK/RESET** or button **OK**. The stored speed is deleted.

The warning can be adjusted for speeds between 30 km/h (18 mph) and 250 km/h (155 mph).

Display Oil temperature

The engine reaches its operating temperature when, under normal driving conditions, the oil temperature is between **80°C** (176°F) and **120°C** (248°F). If a great effort is required from the engine and the outside temperature is high, the engine oil temperature may increase. This does not present any problem as long as the warning lamps  or  »» page 267 do not appear on the display.

Warning and information messages (Vehicle status)

The system runs a check on certain components and functions when the ignition is switched on and while the vehicle is moving. Faults displayed on the instrument panel as red and yellow warning symbols accompanied with messages and, depending on the case, even an audible warning »» page 84. The representation of the messages and »

¹⁾ Not available in all countries.

symbols may vary depending on the version of the instrument panel.

Existing faults can also be checked manually. To do so, open the menu **Vehicle status** or **Vehicle** » page 73.

Priority 1 warning (red)

The symbol lights up or flashes (in part accompanied by audible warnings). **Stop driving!** Danger! Check the fault and eliminate the cause. If necessary, seek professional assistance.

Priority 2 warning (yellow)

The symbol lights up or flashes (in part accompanied by audible warnings). Operating faults or the lack of operating fluids can cause damage to the vehicle or a fault. Check the faulty function as soon as possible. If necessary, seek professional assistance.

Information message

It provides information about processes in the vehicle.

Driver alert system (break recommendation)*



Fig. 67 On the instrument panel display: driver alert system symbol.

The Fatigue detection informs the driver when their driving behaviour shows signs of fatigue.

Function and operation

Fatigue detection determines the driving behaviour of the driver when starting a journey, making a calculation of tiredness. This is constantly compared with the current driving behaviour. If the system detects that the driver is tired, an audible warning is given with a sound and an optic warning is shown with a symbol and complementary message on the instrument panel display » **Fig. 67**. The message on the instrument panel display is shown for approximately 5 seconds, and depending on the case, is repeated. The system stores the last message displayed.

The message on the instrument panel display can be switched off by pressing the **OK/RESET** button on the windscreen wiper lever or the button **OK** on the multi function steering wheel » page 82.

The message can be recalled to the instrument panel display using the multifunction display » page 74.

Conditions of operation

Driving behaviour is only calculated on speeds above about 65 km/h (40 mph) up to around 200 km/h (125 mph).

Switching on and off

Fatigue detection can be activated or deactivated in the infotainment system using the function button **☰** > **Driver assistance** > **Fatigue detector** » page 90. A mark indicates that the adjustment has been activated.

System limitations

The Fatigue detection has certain limitations inherent to the system. The following conditions can limit the Fatigue detection or prevent it from functioning.

- At speeds below 65 km/h (40 mph)
- At speeds above 200 km/h (125 mph)
- When cornering
- On roads in poor condition

- In unfavourable weather conditions
- When a sporty driving style is employed
- In the event of a serious distraction to the driver

Fatigue detection will be restored when the vehicle is stopped for more than 15 minutes, when the ignition is switched off or when the driver has unbuckled their seat belt and opened the door.

In the event of slow driving during a long period of time (below 65 km/h, 40 mph) the system automatically re-establishes the tiredness calculation. When driving at a faster speed the driving behaviour will be recalculated.

WARNING

Do not let the comfort afforded by the Fatigue detection system tempt you into taking any risks when driving. Take regular breaks, sufficient in length when making long journeys.

- The driver always assumes the responsibility of driving to their full capacity.
- Never drive if you are tired.
- The system does not detect the tiredness of the driver in all circumstances. Consult the information in the section »» page 76, System limitations.

- In some situations, the system may incorrectly interpret an intended driving manoeuvre as driver tiredness.

- No warning is given in the event of the effect called microsleep!

- Please observe the indications on the instrument panel and act as is necessary.


Note

- Fatigue detection has been developed for driving on motorways and well paved roads only.

- If there is a fault in the system, have it checked by a specialised workshop.

Time

Setting the time on the infotainment system

- Press the infotainment button **CAR** / .
- Press the function button **SETTINGS** > **Date and time** to set the time »» page 86.

Setting the time on analogue the instrument panel

- To set the time (for all vehicle clocks), press and hold the button **0.0/SET** on the instrument panel until the **Time** is displayed.

- Release the button **0.0/SET**. The time is displayed on the instrument panel display and the hours field is highlighted.


- Afterwards, press the button **0.0/SET** until the desired time is displayed. To scroll quickly, hold the button **0.0/SET**.

- When they have finished setting the hour, wait until the minute field is marked on the instrument panel display.

- Afterwards, press the button **0.0/SET** until the desired time is displayed. To scroll quickly, hold the button **0.0/SET**.

- Release the button **0.0/SET** in order to finish setting the time.

Adjusting the time in the SEAT Digital Cockpit

- While in the **Driving data** menu select the **Range** function (infotainment button **CAR** /  > **View** > **Driving data** > **Range**).

- Press the button **OK** on the multifunction steering wheel until the Service menu is displayed on the instrument panel display »» page 74.

- Select the menu **Time**.

- Adjust the correct time by turning the right thumbwheel of the multifunction steering wheel.

Revolution counter

The rev counter indicates the number of engine revolutions per minute.

Together with the gear-change indicator, the rev counter offers you the possibility of using the engine of your vehicle at a suitable speed.

The beginning of the red zone of the rev counter indicates the maximum speed in any gear after running-in and with the engine hot. However, it is advisable to change up a gear or move the selector lever to **D** (or lift your foot off the accelerator) before the needle reaches the red zone »»» ⓘ.

We recommend that you avoid high revs and that you follow the recommendations on the gear-change indicator. Consult the additional information in »»» page 205, **Selecting the optimal gear.**

ⓘ CAUTION

- To prevent damage to the engine, the rev counter needle should only remain in the red zone for a short period of time.
- When the engine is cold, avoid high revs and heavy acceleration and do not make the engine work hard.

🌿 For the sake of the environment

Changing up a gear early will help you to save fuel and minimise emissions and engine noise.

Fuel gauge



Fig. 68 Analogue instrument panel: fuel gauge



Fig. 69 Digital instrument panel: fuel gauge.

Control lamps



It lights up, and in addition, the lower diode lights up in red

Fuel tank almost empty. The fuel reserve level has been reached »»» ⚠. Refuel as soon as you have the opportunity. When the fuel level is very low, the lower diode flashes red.



It lights up yellow

Presence of water in diesel. Turn off the engine and seek professional assistance.

The display only works when the ignition is switched on.

The fuel range is displayed on the instrument panel.

You can consult the tank capacity of your vehicle in the »»» page 302 section.

⚠ WARNING

When driving with low fuel, the vehicle may stall in traffic and cause accidents and severe injuries.

- If the fuel tank level is too low, fuel could reach the engine irregularly, particularly when driving up or down slopes.
- The steering system and the driver assistance systems and brakes do not work when the engine is running irregularly or

switches off due to lack of fuel or an irregular supply thereof.

- Always refuel when there is only one quarter of fuel in tank to prevent the vehicle to stop due to lack of fuel.

⚠ CAUTION

Never run the fuel tank completely dry. An irregular fuel supply can cause misfiring and unburnt fuel could enter the exhaust system. The catalytic converter or the particulate filter may get damaged!

i Note

The small arrow on the fuel gauge next to the fuel pump symbol points out towards the side of the vehicle with the fuel tank flap.

Natural gas level (CNG)

- ✓ Valid in vehicles equipped with natural gas engine (CNG)

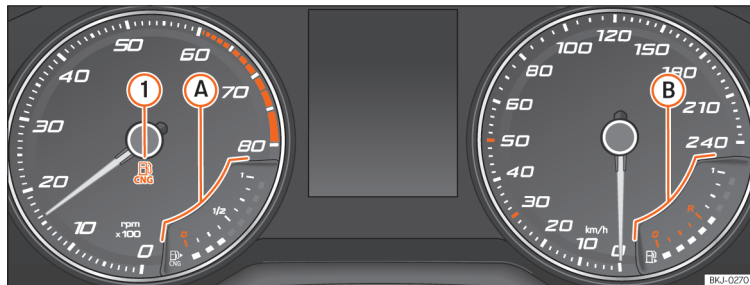


Fig.70 Analogue instrument panel: natural gas gauge

- A** Natural gas gauge
- B** Petrol gauge

Control lamp



It lights up green »» Fig. 70 ①

The vehicle is running on natural gas. The lamp goes off when the natural gas runs out. The engine changes to operate with petrol.



It lights up, and in addition, the lower diode lights up in red

The fuel reserve level has been reached. When the fuel level is very low, the lower diode flashes red.

The display only works when the ignition is switched on.

»

Things to note

If the vehicle is left parked for a long time immediately after refuelling, the natural gas level indicator may not accurately indicate the same level shown after refuelling when the vehicle is started up again. This is not due to a leak in the system, but to a drop in pressure in the gas tank for technical reasons after a cooling phase just after refuelling.

i Note

In vehicles with natural gas engines, the petrol tank fuel level gauge may display the refuelled amount with a slight delay (depending on the refuelled amount).

Engine coolant temperature indicator.

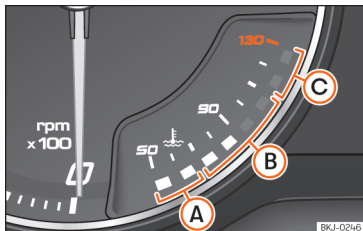


Fig. 71 Analogue instrument panel: engine coolant temperature indicator.

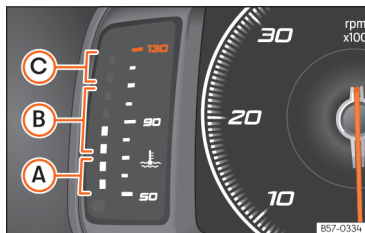




Fig. 72 Digital instrument panel: engine coolant temperature indicator.

- A Cool zone.** The engine has not reached operating temperature yet. Avoid high speeds and stressing the engine if it has not reached operating temperature.
- B Normal zone.** At high outside temperatures and when making the engine work hard, the diodes may continue lighting up and reach the upper zone. This is no cause for concern, provided the control lamp does not light up .
- C Warning area.** When the engine is working hard, especially at high outside temperatures, the diodes may light up in the warning area.

The coolant temperature gauge only works when the ignition is switched on.

Control and warning lamp

It lights up red

 **Do not carry on driving!**
Engine coolant level too low, coolant temperature too high.

Flashes red

Fault in the engine coolant system.

- Stop the vehicle, switch off the engine and let it cool down.
- Check the engine coolant level
»» page 269.
- If the warning lamp does not switch off even if the coolant level is correct, request assistance from specialised personnel.

ⓘ CAUTION

- To ensure a long useful life for the engine, avoid high revs, driving at high speed and making the engine work hard for approximately the first 15 minutes when the engine is cold. The phase until the engine is warm also depends on the outside temperature. If necessary, use the engine oil temperature*
»» page 74»» page 75 as a guide.
- Additional lights and other accessories in front of the air inlet reduce the cooling effect of the coolant. At high outside temperatures and high engine loads, there is a risk of the engine overheating.

- The front spoiler also ensures proper distribution of the cooling air when the vehicle is moving. If the spoiler is damaged this can reduce the cooling effect, which could cause the engine to overheat. Seek specialist assistance.

Service intervals

The service interval indication appears on the instrument panel display and the Infotainment system.

There are different versions of instrument panels and infotainment systems, so the versions and instructions on the screens may vary.

SEAT distinguishes between services *with* engine oil change (e.g. Oil change service) and services *without* engine oil change (e.g. Inspection).

In vehicles with **Services established by time or mileage**, the service intervals are already pre-defined.

In vehicles with **LongLife Service**, the intervals are determined individually. Thanks to technological progress, maintenance work has been greatly reduced. Because of the technology used by SEAT, with this service you only need to change the oil when the vehicle so requires. To calculate this variation (max. 2 years), the vehicle's conditions of use


and individual driving styles are considered. The advance warning first appears 20 days before the date established for the corresponding service. The kilometres (miles) remaining until the next service are always rounded up to the nearest 100 km (miles) and the time is given in complete days. The current service message cannot be viewed until 500 km after the last service. Prior to this, only lines are visible on the display.

Inspection reminder

If a service or an inspection has to be carried out soon, a **service reminder** will be displayed when the ignition is switched on.

The figure displayed are the kilometres that can still be travelled or the time until the next service.

Service due

When **the time for a service** or an **inspection** comes, an audible warning will be emitted when the ignition is switched on and the fixed key symbol  may appear on the instrument panel for a few seconds, along with one of the following messages:

- **Service now!**
- **Please have your vehicle inspected.**
- **Oil change service due!**

- **Oil change service and inspection due!**

Inspection of compressed natural gas tanks (CNG) reminder


When less than 90 days for the review of the compressed natural gas tanks (CNG), when the ignition is switched on, the instrument panel display will a **reminder for review of the gas tanks** and an audible warning will be emitted.

As approaches the service date of inspection of the gas tanks, the message and the audible warning will stop modify accordingly.


Consult a service notification

With the ignition switched on, the engine off and the vehicle at a standstill, the current **service notification** can be read:

Check the date of the current service on the infotainment system

- Press the infotainment button **CAR** / .
- Press the **SETTINGS** >>> **page 86** function button.
- Select the **Service** menu option to display information about the services.

Vehicles with analogue instrument panel

- Press and hold the button **0.0/SET** >>> **Fig. 65**  for more than 5 seconds to consult the service message

»

Vehicles with digital instrument panel

- The date of the service can only be read through the Service menu »» page 74.

Resetting service interval display

If the service was not carried out by a SEAT dealership, the display can be reset as follows:

Vehicles with analogue instrument panel

- Switch off the ignition, press and hold button **0.0/SET** »» Fig. 65 ④.
- Switch ignition back on.
- Release the **0.0/SET** button and press it again for the next 20 seconds.

Vehicles with digital instrument panel

- The service interval display can only be reset through the Service menu »» page 74.

Do not restart the indicator between the service intervals, otherwise the information displayed will be incorrect.

If the oil change service is reset manually, the service interval display changes to a fixed service interval, also in vehicles with **Flexible oil change service**.

Note

- The service message disappears after a few seconds, when the engine is started or when **OK/RESET** button is pressed on the wiper

lever, or the **OK** button on the multifunction steering wheel.

- In vehicles with the LongLife system in which the battery has been disconnected for a long period of time, it is not possible to calculate the date of the next service. Therefore the service interval display may not be correct. In this case, bear in mind the maximum service intervals permitted »» page 286.

- If you reset the display manually, the next service interval will be indicated as in vehicles with fixed service intervals. For this reason we recommend that the service interval display be reset by a SEAT authorised Dealer.

- If the period of 48 months for an inspection at a specialised workshop of compressed natural gas tanks (CNG) is exceeded, the vehicle may not working in this mode.

In vehicles with multifunction steering wheel, the multifunction display can only be operated with the steering wheel buttons.

Some menu options can only be read when the vehicle is at a standstill.

WARNING

Distracting the driver in any way can lead to an accident and cause injuries.

- Never use the menus on the instrument panel display while the vehicle is in motion.

Note

After loading or changing the 12-volt battery, check the system settings. If the power supply is interrupted, the system settings might be incorrect or deleted.

Using the instrument panel

Introduction

With the ignition switched on, it is possible to read the different functions of the display by scrolling through the menus.

Operation using the multifunction steering wheel

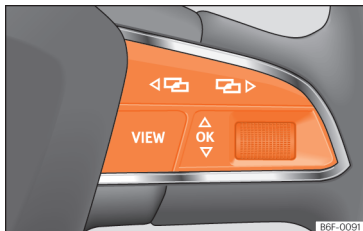


Fig. 73 Right side of the multifunction steering wheel: buttons to the menus and information displays on the instrument panel.

As long as a priority 1 » page 75 warning is active, it will not be possible to access any menu. Some warnings can be confirmed and hidden with the button **OK** of the multifunction steering wheel » **Fig. 73**.

Select a menu or an informative display

- Switch the ignition on.
- If a message or vehicle symbol is displayed, press the button **OK** » **Fig. 73**; if necessary, several times.
- To change menus, use buttons **◀** or **▶** » **Fig. 73**.
- To open the menu or the information displayed, press the button **OK** » **Fig. 73** or wait

a few seconds until the menu or the informative display opens automatically.

Changing menu settings

- In the menu displayed, turn the right thumbwheel of the multifunction steering wheel » **Fig. 73** until the desired option of the menu is highlighted. The option appears framed.
- Press the button **OK** » **Fig. 73** to make the required modifications. A mark indicates that the system or function is activated.

Back to menu selection

Press the button **◀** or **▶** » **Fig. 73**.

Operation with the wiper lever

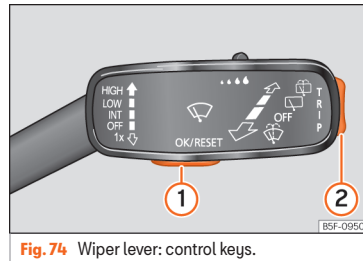


Fig. 74 Wiper lever: control keys.

As long as a priority 1 » page 75 warning is active, it will not be possible to access any

menu. Some warnings can be confirmed and hidden with the button » **Fig. 74** ①.

Select a menu or an informative display

- Switch the ignition on.
- If a message or vehicle symbol is displayed, press button ①; if necessary, several times.
- To display the menus » page 73 or to return to the selection of menus from a menu or from an informative display, hold down the rocker button ②.
- To change from one menu to another, press the upper or lower part of the rocker switch.
- To open the menu or the informative display shown, press button ① or wait a few seconds until the menu or the informative display opens automatically.

Changing menu settings

- In the menu displayed, press the upper or lower part of the rocker switch ② until the required menu option is checked. The option appears framed.
- Press button ① to make the required modifications. A mark indicates that the system or function is activated.

Back to menu selection

Select **Back** on the corresponding menu to exit. »

Note

If when switching on the ignition warnings are shown about existing faults, it might not be possible to change the settings or show the information as described. In this case, go to a specialised workshop and request a repair.

Control lamps

Control and warning lamps

The control and warning lamps are indicators of warnings \ggg Δ , faults or certain functions. Some control and warning lamps come on when the ignition is switched on, and switch off when the engine starts running, or while driving.

Depending on the model, additional text messages may be viewed on the instrument panel display. These may be purely informative or they may be advising of the need for action \ggg page 68, Instrument panel.

Depending upon the equipment fitted in the vehicle, instead of a warning lamp, sometimes a symbol may be displayed on the instrument panel.

When certain control and warning lamps are lit, an audible warning is also heard.

Red warning lamps






	Notification central lamp: additional information on the instrument panel display
	Parking brake on \ggg page 228.
	Fault in the brake system \ggg page 228.
	Fault in the steering system \ggg page 206.
	Driver or passenger has not fastened seat belt \ggg page 16.
	Engine cooling fluid \ggg page 80.
	Engine oil pressure \ggg page 267.
	Alternator abnormality \ggg page 274.
	Press the foot brake \ggg page 222.
	AdBlue level too low, OR fault in the SCR system \ggg page 260 .

Yellow warning lamps


	Notification central lamp: additional information on the instrument panel display
	Fault in ESC or disconnection caused by the system; OR ESC or ASR in operation \ggg page 231.
	ASR manually deactivated; OR ESC in Sport mode \ggg page 231.
	Fault in the ABS \ggg page 231.
	Rear fog light switched on \ggg page 115.

	Fault in the emission control system \ggg page 262.
	Pre-heating of the diesel engine; OR fault in the management of the diesel engine \ggg page 262.
EPC	Fault in the petrol engine management \ggg page 262.
	Particulate filter blocked \ggg page 262.
	Fault in the steering system \ggg page 206.
	Tyre monitor system \ggg page 282.
	Fuel tank almost empty \ggg page 78.
	Adblue level low, OR fault in the SCR system \ggg page 260.
	Fault in airbag system and seat belt tensioners \ggg page 24.
OFF	Front passenger front airbag disabled \ggg page 24.
ON	Front passenger airbag switched on \ggg page 24.
	Fault in the lighting of the vehicle \ggg page 115.
	Low engine oil level \ggg page 267.
	Fault in the gearbox \ggg page 204.








Green indicator lamps

	Turn lights or emergency lights on »» page 115.
	Trailer turn signals »» page 115.
	Press the foot brake »» page 199.
	Cruise control (GRA) »» page 213; OR speed limited »» page 216; OR Adaptive cruise control (ACC) »» page 224.
	Natural gas operating mode »» page 79.

Blue indicator lamps

	Main beam on or flasher on »» page 115.
---	---

Other warning lamps

	Door(s), rear lid or bonnet open or not properly closed »» page 72.
	Service interval display »» page 81.
	Mobile phone connected through Blue- tooth®.
	Mobile phone charge level.
	Risk of freezing »» page 72.
	Start-Stop system activated »» page 196.
	Start-Stop system unavailable »» page 196.
	Low consumption driving status »» page 73.

 **WARNING**

If the warning lamps and messages are ignored, faults may occur in the vehicle, it may stall in traffic, or accidents and serious injuries may occur.

- Never ignore the warning lamps or text messages.
- Stop the vehicle safely as soon as possible.
- A faulty vehicle represents a risk of accident for the driver and for other road users. If necessary, switch on the hazard warning lamps and put out the warning triangle to advise other drivers.
- Before opening the bonnet, switch off the engine and allow it to cool.
- In any vehicle, the engine compartment is a hazardous area and could cause severe injuries »» page 264.

Infotainment system

Introduction

The infotainment system brings together important vehicle functions and systems into a single central control unit, e.g. air conditioning, menu settings, radio equipment and the navigation system.

The actual number of menus available and the name of the various options will depend on the vehicle's electronics and equipment.

General operating information

General information on the operation of the infotainment system, as well as on the warning and safety instructions that must be taken into account, is found in »» page 146.

How to move through the different menus and select them

- Switch the ignition on.
- If the Infotainment system is off, switch it on.
- The different menus are selected directly on the touch screen using texts, icons or buttons.

If the box is checked ✓, the function is activated.

Pressing the menu button < will always take you to the last menu used.

Any changes made using the settings menus are automatically saved on closing those menus.

Scroll bar: Some menus and functions show more content above or below those displayed on the screen at that time, for exam-

ple, long lists of settings. Press on the scroll bar and pull up or down.

Tutorial

The first time you connect the Infotainment system, a system tutorial will open with a brief description of the main functions and how to use it.

Help

In the **Help** menu you will find more information and tips for using the Infotainment system.

WARNING

Any distraction may lead to an accident, with the risk of injury. Operating the Infotainment system while driving could distract you from traffic.

Explanation of the function buttons

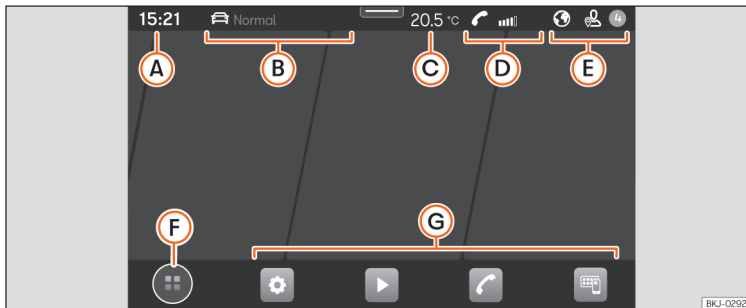


Fig. 75 Schematic representation: Overview of the possible function buttons on the screen

Top part of the screen

- A** **Current time**
- B** **Driving profile and navigation information.** If the user has an active route, both the time and the distance to the destination are displayed. If there is no active route, the driving profile is displayed. On vehicles with no available driving profile, the current address is displayed whenever there is no active route.
- C** **Air conditioning information.** In vehicles with heated steering wheels or wind-screen heating, the corresponding icon is

displayed when these functions are enabled. If not, the current outside temperature is displayed.

- D** **Telephone information.** Information regarding your mobile device is displayed: available network signal strength, established Bluetooth connection, unanswered calls, new messages, battery status, etc.
- E** **Number of notifications and customization of the system depending on the user and connectivity.**

Bottom part of the screen

- F** Main menu display mode:

⌘: main menu with the 6 main functions divided into 2 screens (3 + 3, customisable by the user by pressing on the function).

⊞: main menu in mosaic mode (all functions of the Infotainment system)

- G** Direct accesses to the functions of the Infotainment system (up to 8 functions, 4 + 4, customisable by the user). By pressing on the icon, you can select/deselect the functions in question.

Initial configuration wizard

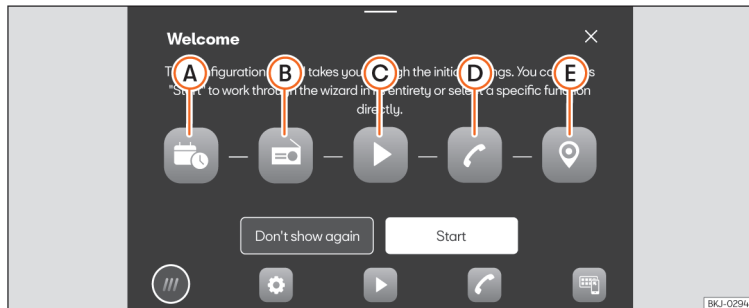


Fig. 76 Schematic representation: Initial configuration wizard

The initial configuration wizard will help you to set up your Infotainment system the first time you switch it on.

Every time you switch on the Infotainment system, the initial setup screen will be displayed » **Fig. 76** if any parameters have not been set (marked with "✓") or if the **Don't show again** function button has not been pressed.

Function button: Function

✕ Closes the Configuration Wizard.

Function button: Function

A	Press to set day and time.
B	Press to search and store to memory the radio stations that have the best reception at that moment.
C	Press to go to the Online Media settings.
D	Press to link your mobile phone to the Infotainment system.

Function button: Function

E	Press to select your home address using your current position or by manually entering an address.
Don't show again	Disables the possibility of changing the settings of the Infotainment system. If you wish to perform the initial configuration, you must access through Help .
Start	Starts up the Configuration Wizard.
End	Once one or more settings have been applied, press to finalise the setup in the main menu of the wizard.

Vehicle information

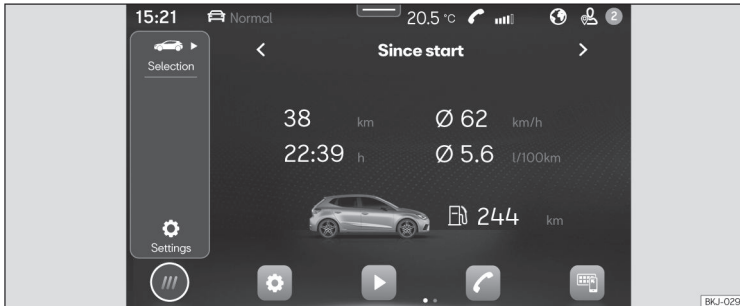


Fig.77 Schematic representation: Vehicle information and status

Pressing on > **Selection** and then on **Vehicle info** opens the **Vehicle information** menu with the following submenus:

- **Driving data.** The average consumption, average speed, distance travelled, trip duration and autonomy are shown. It has 3 memories: "From departure", "Total calculation" and "From refuelling" **>>> page 74.**
- **Vehicle status.** The warnings regarding faults, incidents, memorisation of the tyre pressure or information of the next inspection service are displayed.

Assist systems and vehicle settings



Fig.78 Schematic representation: Assist systems and vehicle settings

The number of assist systems and settings depend on the version and the country in question.

- **Driver assistance**
 - Park assist »» page 234.
 - Activate / deactivate ESC, stabilisation systems and brake assist »» page 231.
 - Activate / deactivate the Start-Stop system »» page 196.
 - Adaptive cruise control (ACC) »» page 222.
 - Emergency brake assistance system (Front Assist) »» page 219.
 - Fatigue detection »» page 76.

Multifunction steering wheel*

Operation of the audio, telephone and navigation system with voice control

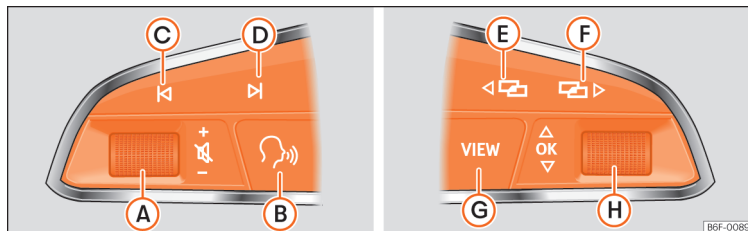


Fig. 79 Controls on the steering wheel.

The steering wheel includes a multifunction module from where it is possible to control

the audio, telephone and radio/navigation functions without needing to distract the driver.

Applies to vehicles with analogue instrument panel

Button	Radio	Media	Telephone*	Navigation*
A Turn	Turn volume up/down.	Turn volume up/down.	Turn volume up/down.	Turn announcement volume up/down.
A Press	Mute volume.	Mute volume.	Mute incoming call.	Mute voice navigation
B ^{a)}	Activate/deactivate voice control. ^{b)} This function can be used from any mode, except in the case of an active call.			
C / D	Search for the previous/next station ^{c)} .	Short press: Switch to the previous/next track. Long press: Fast rewind/forward ^{d)} .	- No active call: Radio/Media functionality - Active call: no function	No function for the other modes (navigation, assistants, vehicle status, travel data).

»

Operation

Button	Radio	Media	Telephone*	Navigation*
E / F ^{a)}	Change menu on instrument panel. This function can be used from any mode (audio, media, navigation, vehicle status, travel data).			
G	<i>Colour instrument panel:</i> switch to the previous menu. <i>Monochrome instrument panel:</i> switch to the previous function.			
H Turn	<i>Coloured instrument panel:</i> List of stations available (only if the instrument panel is in audio menu).	<i>Coloured instrument panel:</i> next track (only if the instrument panel is in audio menu).	– <i>There is no active call:</i> Recent calls list. – <i>Active call:</i> go to the call options list (call in standby, hang up, mute microphone, private number, etc.).	– <i>Active route:</i> access the view to stop route guidance. – <i>No active route:</i> list last destinations.
H Press	Acts on the instrument panel or confirms the instrument panel menu option depending on the menu option.			

^{a)} According to the vehicle's equipment package.

^{b)} This function can be used from any mode (audio, media, navigation, vehicle status, travel data).




^{c)} This action can be performed when you are listening to the radio; there is no need to be in audio-radio mode.

^{d)} These actions can be performed when you are listening to media; there is no need to be in audio-radio mode.

Applies to vehicles with Active Info Display (Digital SEAT Cockpit)

Button	Radio	Media	Telephone*	Navigation*
A Turn	Turn volume up/down.	Turn volume up/down.	Turn volume up/down.	Turn announcement volume up/down.
A Press	Mute volume.	Mute volume.	Mute incoming call.	Mute voice navigation.
B ^{a)}	Enable/disable voice control ^{b)} . This function can be used from any mode, except in the case of an active call.			
C / D	Search for the previous/next station ^{c)} .	<i>Short press:</i> Switch to the previous/next track. <i>Long press:</i> Fast rewind/forward ^{d)} .	– <i>No active call:</i> Radio/Media functionality – <i>Active call:</i> no function	No function for the other modes (navigation, assistants, vehicle status, travel data).
E / F ^{a)}	Change menu on instrument panel. ^{b)}			

Instruments and warning/control lamps

Button	Radio	Media	Telephone*	Navigation*
	Short press ^{b)} : change views Classic / Navigation / Dynamic Long press ^{b)} : access the "Personalised Profiles" configuration view.			
 Turn	List of sources available (audio/media).	List of sources available (audio/media).	– <i>There is no active call</i> : Recent calls list. – <i>Active call</i> : go to the call options list (call in standby, hang up, mute microphone, private number, etc.).	If there is a map on the Digital Scorecard: Zoom in-out (with and without active route). If there is no map on the Digital Panel: the map is transferred from the infotainment System display to the Digital Panel (with and without active route).
 Press	No function	No function	No function	Auto/Manual Zoom Zoom if the map on the DigitScorecard.

^{a)} According to the vehicle's equipment package.

^{b)} This function can be used from any mode (audio, media, navigation, vehicle status, travel data).

^{c)} This action can be performed when you are listening to the radio; there is no need to be in audio-radio mode.

^{d)} These actions can be performed when you are listening to media; there is no need to be in audio-radio mode.

Operation of the audio, telephone and navigation system without voice control

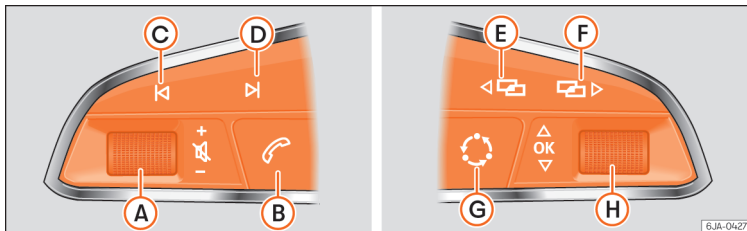





Fig. 80 Controls on the steering wheel.

The steering wheel includes a multifunction module from where it is possible to control

the audio, telephone and radio/navigation functions without needing to distract the driver.

Button	Radio	Media	Telephone*	Navigation*
A Turn	Turn volume up/down.	Turn volume up/down.	Turn volume up/down.	Turn announcement volume up/down.
A Press	Mute volume.	Mute volume.	Mute incoming call.	Mute voice navigation.
B ^{a)}	– <i>Incoming call</i> : pick up (short press), reject (long press). – <i>Active call</i> : hang up active call (short press). – <i>No active / incoming call</i> : open phone menu (short press), re-dial the last active call (long press). This function can be used from any mode (audio, media, navigation, assistants, vehicle status, driving data).			
C / D	Search for the previous/next station ^{b)} .	Short press: Switch to the previous/next track. Long press: Fast rewind/forward ^{c)} .	– <i>No active call</i> : Radio/Media functionality – <i>Active call</i> : no function	No function for the other modes (navigation, assistants, vehicle status, travel data).
E / F ^{a)}	Change menu on instrument panel. This function can be used from any mode (audio, media, navigation, vehicle status, travel data).			

Instruments and warning/control lamps

Button	Radio	Media	Telephone*	Navigation*
	Cycles through the audio source: FM/AM – SD - USB - BT Audio (only if available). This function can be used from any mode (audio, media, navigation, vehicle status, travel data).			
 Turn	<i>Coloured instrument panel:</i> List of stations available (only if the instrument panel is in audio menu).	<i>Coloured instrument panel:</i> next track (only if the instrument panel is in audio menu).	– <i>There is no active call:</i> Recent calls list. – <i>Active call:</i> go to the call options list (call in standby, hang up, mute microphone, private number, etc.).	– <i>Active route:</i> access the view to stop route guidance. – <i>No active route:</i> list last destinations.
 Press	Acts on the instrument panel or confirms the instrument panel menu option depending on the menu option.			

- ^{a)} According to the vehicle's equipment package.
- ^{b)} This action can be performed when you are listening to the radio; there is no need to be in audio-radio mode.
- ^{c)} These actions can be performed when you are listening to media; there is no need to be in audio-radio mode.

Opening and closing

Set of vehicle keys

Vehicle key

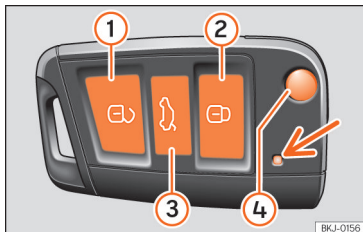


Fig. 81 Assignment of buttons on the remote control key.

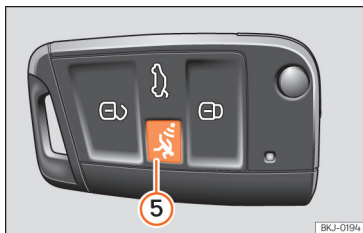


Fig. 82 Vehicle key with alarm button.

Key to the »» Fig. 81, »» Fig. 82

- ① Unlock the vehicle
- ② Lock the vehicle
- ③ Unlock only the rear lid. Press the button until all the turn signals on the vehicle flash briefly. You have 2 minutes to open the rear lid. Once this time has passed, it will lock again. In addition, the lamp on the key flashes.
- ④ Folding the key shaft in and out
- ⑤ Alarm button*. Only press in the event of an emergency! When the alarm button is pressed, the vehicle's sounds and the turn signals light up for a short time. Press again to disconnect.

With the vehicle key the vehicle may be locked or unlocked remotely »» page 98.

The vehicle key includes an emitter and battery. The receiver is in the interior of the vehicle. The range of the vehicle key with remote control and new battery is several metres around the vehicle.

If it is not possible to open or close the vehicle using the remote control key, this should be re-synchronised »» page 98 or the battery changed »» page 97.

Different keys belonging to the vehicle may be used.

Control lamp on the vehicle key

When a button on the vehicle key is pressed, the control lamp flashes »» Fig. 81 (arrow) once briefly, but if the button is held down for a longer period the control lamp flashes several times, such as in convenience opening.

If the vehicle key control lamp does not light up when the button is pressed, replace the key's battery »» page 97.

Spare key

To obtain a spare key and other vehicle keys, the vehicle ID number is required.

Each new key contains a microchip which must be coded with the data from the vehicle electronic immobiliser. A vehicle key will not work if it does not contain a microchip or the microchip has not been encoded. This is also true for keys which are specially cut for the vehicle.

The vehicle keys or new spare keys can be obtained from a SEAT Official Service, a specialised workshop or an approved key service qualified to create this kind of key.

New keys or spare keys must be synchronised before use »» page 98.

⚠ WARNING

- **Never leave children or disabled persons in the vehicle. In case of emergency, they**

may not be able to leave the vehicle or manage on their own.

- An uncontrolled use of the key could start the engine or activate any electric equipment (e.g. electric windows), causing risk of accident. The doors can be locked using the remote control key. This could become an obstacle for assistance in an emergency situation.
- Never forget the keys inside the vehicle. An unauthorised use of your vehicle could result in injury, damage or theft. Therefore always take the key with you when you leave the vehicle.
- Never remove the key from the ignition if the vehicle is in motion. Otherwise, the steering could suddenly block and it would be impossible to steer the vehicle.

CAUTION

All of the vehicle keys contain electronic components. Protect them from damage, impacts and humidity.

Note

- Only use the key button when you require the corresponding function. Pushing the button unnecessarily could accidentally unlock the vehicle or trigger the alarm. It is also possible even when you are outside the radius of action.

- Key operation can be greatly influenced by overlapping radio signals close to the vehicle working in the same range of frequencies, for example, radio transmitters or mobile telephones.
- Obstacles between the remote control and the vehicle, bad weather conditions and discharged batteries can considerably reduce the range of the remote control.
- If the buttons of the vehicle key are pressed or one of the central locking buttons **>>> page 101** is pressed repeatedly in short succession, the central locking briefly disconnects as protection against overloading. The vehicle is then unlocked. Lock it if necessary.
- Spare remote control keys are available at your Technical Service, where they must be matched to the locking system.
- Up to five remote control keys can be used.

To change the battery

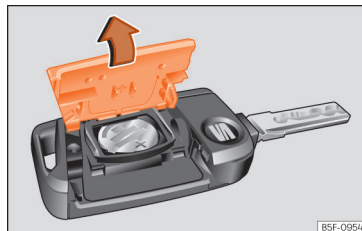


Fig. 83 Vehicle key: opening the battery compartment cover.

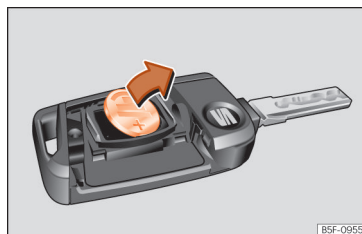


Fig. 84 Vehicle key: removing the battery.

SEAT recommends you ask a specialised workshop to replace the battery.

The battery is located to the rear of the vehicle key, under a cover. **>>**

Changing the battery

- Unfold the vehicle key blade »» page 96.
- Remove the cover from the back of the vehicle key »» Fig. 83 in the direction of the arrow »» ❶.
- Extract the battery from the compartment using a suitable thin object »» Fig. 84.
- Place the new battery in the compartment as shown »» Fig. 84, pressing in the opposite direction to that shown by the arrow »» ❷.
- Fit the cover as shown »» Fig. 83, pressing it onto the vehicle key casing in the opposite direction to that shown by the arrow until it clicks into place.

⚠ WARNING

Swallowing a battery with a 20 mm diameter or any other button battery can cause serious and even fatal injuries within a very short time.

- Keep the vehicle key and key fobs with batteries out of reach of children.
- If you suspect that someone may have swallowed a battery, seek immediate medical attention.

❗ CAUTION

- If the battery is not changed correctly, the vehicle key may be damaged.
- Use of unsuitable batteries may damage the vehicle key. For this reason, always re-


place the dead battery with another of the same voltage, size and specifications.

- When fitting the battery, check that the polarity is correct.


♻ For the sake of the environment

Please dispose of your used batteries correctly and with respect for the environment.


Synchronize the vehicle key

If the  button is pressed frequently outside of the vehicle range, it is possible that the vehicle can no longer be locked or unlocked using the key. In this case, the key must be re-synchronised as described below:

While the vehicle is open:

- Press the  button on the vehicle key.
- Then close the vehicle using the key shaft **within one minute**. If necessary, remove the cover from the driver door lever »» page 108.

While the vehicle is closed:

- Press the  button on the vehicle key.
- Then close the vehicle using the key shaft **within one minute**. If necessary, remove the cover from the driver door lever »» page 108.

Central locking

Introduction

Central locking functions correctly when all the doors and the rear lid are correctly shut. If the driver door is open, the vehicle *cannot* be locked with the key.

If the vehicle has the Keyless Access locking and ignition system, it may only be locked with the ignition off and the driver's door closed.

The battery of an unlocked vehicle parked for a long period (e.g. in a private garage) may run down and fail to start the motor.

⚠ WARNING

The incorrect use of the central locking system may cause serious injuries.

- The central locking system will lock all doors. A vehicle locked from the inside can prevent any non-authorized individual from opening the doors and accessing the vehicle. Nevertheless, in case of emergency or accident, locked doors will complicate access to the vehicle interior to help the passengers.
- Never leave children or disabled people alone in the vehicle. The central locking button can be used to lock all the doors from within. Therefore, passengers will be locked inside the vehicle. Individuals locked

in the vehicle can be exposed to very high or very low temperatures.

- Depending on the time of the year, temperatures inside a locked and closed vehicle can be extremely high or extremely low resulting in serious injuries and illness or even death, particularly for young children.
- Never leave individuals locked in a closed and locked vehicle. In case of emergency, they may not be able to exit the vehicle by themselves or get help.

Description

Central locking allows all doors, the rear lid and the tank flap to be unlocked centrally:

- From outside, using the vehicle key
»» page 100.
- From outside with the Keyless Access
»» page 101 system,
- From inside, by pushing the central locking button »» page 101.

Various functions are available to improve the vehicle safety:

- Security system "Safe" »» page 104
- Self-locking system to prevent involuntary unlocking
- Selective unlocking system

- Automatic speed dependent locking and unlocking system (Auto Lock)
- Emergency unlocking system

Self-locking system to prevent involuntary unlocking

It is an anti-theft system and prevents the unintentional unlocking of the vehicle. If the vehicle is unlocked and none of the doors (including the boot) are opened within 30 seconds, it re-locks automatically.

Unlocking one side of the vehicle only

When you lock the vehicle with the key, the doors and the rear lid are locked. When you open the door, you can either unlock *only* the driver door, or all the vehicle doors. To select the required option, use Easy Connect*
»» page 100.

Automatic locking (Auto Lock)*

The Auto Lock function locks the doors and the rear lid when the vehicle exceeds a speed of about 15 km/h (9 mph).

The vehicle is unlocked again when the ignition key is removed. Alternatively, the vehicle can also be unlocked via the central locking switch or by pulling one of the inside door handles.

In the event of an accident in which the airbags inflate, the doors will be automatically unlocked to facilitate access and assistance.

Turn signals

The turn signals will flash twice when the vehicle is unlocked and once when the vehicle is locked.

If it does not flash, this indicates that one of the doors, the rear lid or the bonnet is not closed correctly.

Accidental lock-out

The central locking system prevents you from being locked out of the vehicle in the following situations:

- If the driver door is open, the vehicle cannot be locked with the central locking switch
»» page 101.

Lock the vehicle with the remote control key, when all the doors and the rear lid have been closed. This prevents the accidental locking of the vehicle.

Note


- Never leave any valuable items in the vehicle unattended. Even a locked vehicle is not a safe.
- If the LED on the driver door sill lights up for about 30 seconds when the vehicle is locked, the central locking system or anti-theft alarm* is not working properly. You should have the fault repaired at a SEAT Official Service or specialised workshop. »

- The vehicle interior monitoring of the anti-theft alarm* system will only function as intended if the windows and the sunroof* are closed.


Central locking settings


Central locking settings can be changed in the Easy Connect* system.

Unlocking doors

- Select: button **CAR** /  > **SETTINGS** > **Opening and closing** > **Central locking** > **Unlocking the doors**.

You can choose to unlock **all** the doors or only the **driver door** when you unlock the vehicle. In all the options, the fuel tank flap is also unlocked.

With the **Driver** setting, when you press the  button on the remote control key once, only the driver door is unlocked. If that button is pressed twice, the rest of the doors and the rear lid will be unlocked.

If the  button is pressed, all the vehicle doors are locked. At the same time, a confirmation signal* is heard.

Unlock and lock from the outside

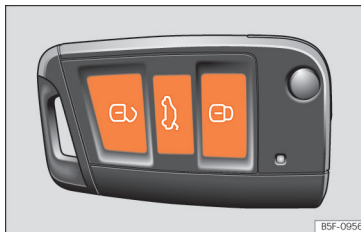







Fig. 85 Remote control key: buttons.

- Lock: press the  **Fig. 85** button.
- Locking the vehicle without the "Safe" security system: push the  button again and hold for 2 seconds.
- Unlock: press the  button.
- Unlocking the rear lid: hold down the  button for at least 1 second.


The vehicle will be locked again automatically if you do not open one of the doors or the rear lid within 30 seconds after unlocking the car. This function prevents the vehicle from remaining unlocked if the unlocking button is pressed by mistake. This does not apply if you press the  button for at least one second.

Selective unlocking system


The selective unlocking system allows you to only unlock the driver door and the fuel tank

flap. All other doors and the rear lid remain locked.

Unlocking the driver's door and tank flap:

- Press (once) the  button on the remote control key or turn the key once in the opening direction.

Unlocking all the doors, the rear lid and the tank flap simultaneously:

- Within 5 seconds, press (twice) the  button on the remote control key, or turn the key twice within 5 seconds in the opening direction.

The Safe* security system and the anti-theft alarm* deactivate immediately when only the driver door is opened.

In vehicles with Easy Connect*, you can programme the security central locking system directly **>>> page 100**.

WARNING

Observe the safety warnings **>>>  in Locking system "Safe" on page 105.**

Note

- **Do not use the remote control key until the vehicle is visible.**
- **Other functions of the remote control key **>>>** page 111, Convenience open/close function.**

Unlocking and locking from the inside



Fig. 86 Centre console: central locking button.

- Lock: press the  »» **Fig. 86** button.
- Unlock: Press the  button again »» **Fig. 86**.


Please note the following when using the central locking switch to lock your vehicle:

- It is not possible to open the doors or the rear lid from the *outside* (for safety reasons, e.g. when stopped at traffic lights).
- The LED in the central locking switch lights up when all the doors are closed and locked.
- You can open the doors individually from the inside by pulling the inside door handle.
- In the event of an accident in which the air-bags inflate, doors locked from the inside will be automatically unlocked to facilitate access and assistance.

WARNING

- The central locking switch also works with the ignition switched off, except when the "safe" system is activated.
- The central locking switch does not operate if the vehicle is locked from the outside and the security system is switched on.
- Locked doors could delay assistance in an emergency. Do not leave anyone, especially children, in the vehicle.

Note

Your vehicle will lock automatically when it reaches a speed of about 15 km/h (9 mph) (Auto Lock) »» page 99. You can unlock the vehicle again using the  button on the central locking switch.

Unlock and lock the vehicle with Keyless Access*

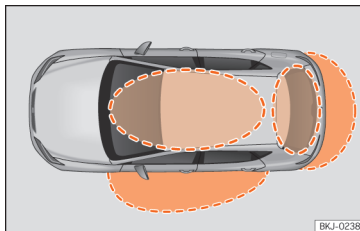


Fig. 87 Keyless Access: proximity zones.

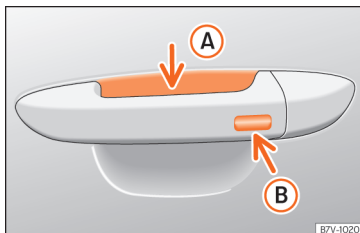


Fig. 88 Door handle: sensor surfaces

»» **Fig. 88**

- A** Unlocking sensor surface on the inside of the door handle.
- B** Locking sensor surface on the outside of the door handle.

»

Depending on the equipment, the vehicle may have the Keyless Access system.

Keyless Access is a key-free locking and ignition system to unlock and lock the vehicle without actively using its key. To do this, all that is required is to have a valid vehicle key in the detection area where you are attempting to access the vehicle »» Fig. 87 and to touch one of the sensor surfaces on the door handles »» Fig. 88 »» ❶.

The vehicle can only be unlocked and locked via the driver's door. When doing so, the remote control key must be no further than approx. 1.5 m away from the door handle.

It does not matter where you carry the key, e.g. in your jacket pocket.

Once the doors have been locked, they cannot be opened again immediately. This will enable you to check that the doors are properly closed.

If you wish you may unlock *only* the corresponding door or the entire vehicle. The necessary adjustments can be made in vehicles with a driver information system »» page 90 »» page 73.

General information

If a valid key is in the proximity of the car »» Fig. 87, the Keyless Access locking and starting system gives the key entry as soon as

one of the sensor surfaces on the front door handles is touched.

The following features are then available without having to use the vehicle key actively:

- *Keyless-Entry*: unlocking the vehicle using the handle of the front driver's door or the *softtouch*/handle on the rear lid.
- *Keyless-Exit*: locking the vehicle using the sensor on the driver door handle.
- *Press & Drive*: keyless starting of the engine with the starter button »» page 191.

The central locking and locking systems operate in the same way as a *normal* locking and unlocking system. Only the controls change.

Unlocking the vehicle is confirmed with a *double* flash of the indicator lights; locking by a *single* flash.

If the vehicle is locked and then all doors and the rear lid are closed leaving the last key used inside the vehicle and none outside, the vehicle will **not** lock **immediately**. All the vehicle's indicator lights will flash *four times*. The vehicle will lock after a few seconds if you do not open any door or the rear lid.

The vehicle will lock again after a few seconds if you unlock the vehicle but fail to open any door or boot hatch.

Unlocking and opening the doors (Keyless-Entry)

- Grip the driver door handle. When you do this, you touch the sensor surface »» Fig. 88 ❶ (arrow) of the handle and the vehicle unlocks.
- Open the door.

On vehicles with selective opening or information system configuration, pulling the door handle twice will unlock all doors.

In vehicles without the "Safe" security system: closing and locking the doors (Keyless-Exit)

- Switch the ignition off.
- Close the driver's door.
- Touch (*once*) the locking sensor surface »» Fig. 88 ❷ (arrow) on the driver's door handle. The door that is used must be closed.

In vehicles with the "Safe" security system: closing and locking the doors (Keyless-Exit)

- Switch the ignition off.
- Close the driver's door.
- Touch (*once*) the sensor surface »» Fig. 88 ❷ (arrow) on the driver's door handle. The vehicle locks with the "Safe" security system »» page 104. The door that is used must be closed.

- Touch (twice) the sensor surface »» Fig. 88 (B) (arrow) of the driver door handle to lock the vehicle without activating the “Safe” security system »» page 104.


Unlocking and locking the boot hatch

When the vehicle is locked, the rear lid automatically unlocks on opening if there is a valid vehicle key in the proximity »» Fig. 87.

Open or close the rear lid *normally*.

After closing, the hatch locks automatically. If the complete vehicle is unlocked, the rear lid will **not** lock automatically after closing it.

What happens when locking the vehicle with a second key

If there is a vehicle key inside the vehicle and it is locked from the outside with a second vehicle key, the key inside the vehicle is blocked for engine ignition »» page 191. In order to enable engine ignition, press the  button on the key inside the vehicle.


Automatically disabling sensors

If the vehicle is not locked or unlocked for a long period of time, the proximity sensors on the passenger doors are automatically disabled.

If one of the sensor surfaces on the door handles is often activated in an unusual manner with the vehicle locked (e.g. by the branches


of a bush rubbing against it), all proximity sensors are disabled for a certain period of time.

Sensors will again be enabled:

- After a time.
- **OR:** if the vehicle is unlocked with the button  on the key.
- **OR:** if the boot is opened.
- **OR:** if the vehicle is unlocked manually with the key.

Keyless Access temporary disconnection function*

You can deactivate the vehicle's Keyless Access unlocking for one locking and unlocking cycle.


- Move the gear lever to position **P** (if the vehicle has automatic gearbox), since otherwise the vehicle cannot be locked.
- Close the door.
- Push the central locking button  on the remote control and touch the locking sensor surface of the driver door handle »» Fig. 88 (B) within the following 5 seconds. Do not grasp the door handle; otherwise the vehicle will not unlock. Deactivation is also possible if the vehicle is locked through the driver's door lock.
- To check that the function has been deactivated, wait at least 10 seconds, grip and pull

on the door handle. The door should not open.

The next time the door can only be unlocked via the remote control or the lock cylinder. The next time the door is locked/unlocked, Keyless Access will be active again.

Convenience functions

To close all the electric windows and the sunroof using the **comfort function**, keep a finger for a few seconds on the locking sensor surface »» Fig. 88 (B) (arrow) of the door handle until the windows and roof have closed.

The way in which the **doors open** when touching the sensor surface on the door handle will depend on the settings activated in the Infotainment system, using the **CAR /  > SETTINGS > Opening and closing** button.

CAUTION

The sensor surfaces on the door handles could engage if hit with a water jet or high pressure steam if there is a valid vehicle key in the proximity. If at least one of the electric windows is open and the sensor surface »» Fig. 88 (B) (arrow) on one of the handles is activated continuously, all windows will close.

Note

- If the vehicle battery has little or no charge, or the vehicle key battery is almost »»

or entirely out of charge, you will probably not be able to lock or unlock the vehicle with the Keyless Access system. The vehicle can be unlocked or locked manually »» page 108.

- To control the proper locking of the vehicle, the release function is disabled for approx. 2 seconds.

- If the message **Keyless access system faulty** is displayed on the screen of the dash panel, abnormalities may occur in the operation of the Keyless Access system. Contact a specialised workshop. SEAT recommends visiting a SEAT dealership for this.

- Depending on the function set on the infotainment system for the mirrors, the exterior mirrors will unfold and the surround lighting will come on when unlocking the vehicle using the sensor surface on the driver and passenger door handles »» page 124.


- If there is no valid key inside the vehicle or the system fails to detect one, a warning will display on the dash panel screen. This could happen if any other radio frequency signal interferes with the key signal (e.g. from a mobile device accessory) or if the key is covered by another object (e.g. an aluminium case).

- If the sensors are very dirty, e.g. have a layer of salt, the correct functioning of the sensors on the door handles may be affected. In this case, clean the vehicle.

- If the vehicle is equipped with an automatic gearbox, it may only be locked in the gear stick is in position P.


- To improve the safety of your vehicle, the remote control of the system is equipped with a position sensor. If this remote control does not detect movement for a certain length of time, the system will conclude that the vehicle cannot be opened (e.g. on a night table) so it will be disabled.

Locking system “Safe”¹⁾

When the vehicle is locked, the “Safe” security system puts the door handles out of operation and makes it difficult for unauthorized people to enter. The doors cannot be opened from inside »» .

Depending on the vehicle, when switching the ignition off, a warning may be displayed on the control panel screen stating that the “Safe” security system is activated.

Lock the vehicle and activate the “Safe” security system.

- Press the locking button  once on the vehicle key.

Lock the vehicle without activating the “Safe” system.

- Press the locking  button on the vehicle key twice.

- *On vehicles with the Keyless Access locking and ignition system:* touch the sensor surface on the outside part of the door handle twice.

When the “Safe” security system is disabled, the following needs to be taken into account:

- The vehicle can be opened and unlocked from the inside using an inside door handle.
- The anti-theft alarm is activated.
- The vehicle interior monitoring system and the anti-tow system are disabled.

“Safe” status

On the driver door, there is warning lamp visible from outside the vehicle through the window which shows the “Safe” system status.

We will know that “Safe” system is activated by the flashing warning lamp. The indicator

¹⁾ Available depending on market and version.

will flash on all vehicles, fitted and not fitted with an alarm, until they unlock.

- “Safe” activated with or without the alarm: continuous flashing of the warning lamp.
- “Safe” deactivated without the alarm: the lamp stays off.
- “Safe” deactivated with the alarm: the warning lamp stays off.

WARNING

Do not leave anyone (especially children) in the vehicle if it is locked from the outside and the “Safe” security system* is activated, as the doors and windows cannot then be opened from the inside. Locked doors could delay assistance in an emergency.

Anti-theft alarm system*

Description

The anti-theft alarm makes it more difficult to break into the vehicle or steal it. The system will initiate acoustic and optical warning signals when your vehicle is tried to be forced.

The anti-theft alarm is automatically turned on when the vehicle is locked with the key. The system is immediately activated and the turn signal light located on the driver door will flash along with the turn signals, indicating

that the alarm and the locking security system (double lock) have been turned on.

If any of the doors or the bonnet are open, they will not be included in the protection zones of the vehicle when the alarm is connected. If the door or the bonnet are subsequently closed, they will be automatically included in the protection areas of the vehicle and the turn signals will flash accordingly when the doors close.

- The turn signal light will flash twice on opening and deactivating the alarm.
- The turn signal light will flash once on closing and activating the alarm.


When does the system trigger an alarm?

The anti-theft alarm siren will be triggered for about 30 seconds alongside a sound and optical (flashing) warning signals and will be repeated about ten times when the vehicle is locked and the following unauthorised actions are attempted:

- Opening a door that is mechanically unlocked using the vehicle key without switching on the ignition in the next 15 seconds (in certain markets, such as the Netherlands, there is no 15 second waiting time and the alarm is activated immediately on opening the door).
- A door is opened.
- Opening the bonnet.
- The rear lid is opened.

- When the ignition is switched on with a non-authorised key.
- Undue manipulation of the alarm.
- Disconnection of the vehicle battery.
- Movement inside the vehicle (in vehicles with interior monitoring »» page 106).
- When the vehicle is towed (in vehicles with anti-tow system »» page 106).
- When the vehicle is raised (in vehicles with anti-tow system »» page 106).
- When the vehicle is transported on a ferry or by rail (vehicles with an anti-tow system or vehicle interior monitoring »» page 106).
- When a trailer connected to the anti-theft alarm system is disconnected.

How to turn OFF the alarm

- Unlock the vehicle with the unlock button  of the key.
- **OR:** turn the ignition on with a valid key.

If the driver's door is unlocked mechanically using the key, the key must be inserted into the ignition, and the ignition must be turned on within 15 seconds of opening the door.


Otherwise, the alarm will trigger for 30 sec. and the ignition will be blocked.

CAUTION

If the anti-theft security system is switched off, the vehicle interior monitoring and the »

tow-away protection are automatically disconnected.

Note

- After 28 days, the indicator light will be switched off to prevent the battery from exhausting if the vehicle has been left parked for a long period of time. The alarm system remains activated.
- If, after the audible warning goes off, another monitored area is accessed (e.g. the rear lid is opened after a door has been opened), the alarm is triggered again.
- The anti-theft alarm is not activated when the vehicle is locked from within using the central locking button .
- If the driver door is unlocked mechanically with the key, only the driver door is unlocked, the rest of the doors remain locked. Only when the ignition has been turned on will the other doors be available - but not unlocked - and the central locking button will be activated.
- If the vehicle battery is run down or flat then the anti-theft alarm will not operate correctly.
- Vehicle monitoring remains active even if the battery is disconnected or not working for any reason.
- The alarm is triggered immediately if one of the battery cables is disconnected while the alarm system is active.

Interior monitoring and the anti-tow system*

It is a monitoring or control function incorporated in the anti-theft alarm* which detects unauthorised vehicle entry by means of ultrasound.



The vehicle interior monitoring and anti-tow sensor (tilt sensor) are automatically switched on when the anti-theft alarm is switched on. In order to activate it, all the doors and the rear lid must be closed.

If the "Safe" security system* » page 104 is switched off, the vehicle interior monitoring and the tow-away protection are automatically disconnected.

Activation

- It is automatically switched on when the anti-theft alarm is activated.

Deactivation


- Open the vehicle with the key, either mechanically or by pressing the  button on the remote control. The time period from when the door is opened until the key is inserted in the contact should not exceed 15 seconds, otherwise the alarm will be triggered.
- Press the  button on the remote control twice. The volumetric sensor and tilt sensors will be deactivated. The alarm system remains activated.

The vehicle interior monitoring and the anti-tow system are automatically switched on again next time the vehicle is locked.

If you wish to switch off the vehicle interior monitoring and the anti-tow system, it must be done each time that the vehicle is locked; if not, they will be automatically switched on.

The vehicle interior monitoring and the anti-tow system should be switched off if animals are left inside the locked vehicle (otherwise, their movements will trigger the alarm) or when, for example, the vehicle is transported or has to be towed with only one axle on the ground.

Deactivation through the infotainment system

- Turn off the ignition and select: button **CAR** /  > **SETTINGS** > **Opening and closing** > **Central locking** > **Interior monitoring**.
- When the vehicle is locked now, the vehicle interior monitoring and the tow-away protection are switched off until the next time the door is opened.

False alarms

Interior monitoring will only operate correctly if the vehicle is completely closed. Please observe related legal requirements.

The following cases may cause a false alarm:

- Open windows (partially or fully).
- Panoramic/tilting sunroof open (partially or completely).
- Movement of objects inside the vehicle, such as loose papers, items hanging from the rear vision mirror (air fresheners), etc.

Note

- If the vehicle is relocked and the alarm is activated without the volumetric sensor function, relocking will activate the alarm with all its functions, except the volumetric sensor. This function is reactivated when the alarm is switched on again, unless it is deliberately switched off.
- If the alarm has been triggered by the volumetric sensor, this will be indicated by a flashing of the warning lamp on the driver door when the vehicle is opened. The flash is different to the flash indicating the alarm is activated.
- The vibration of a mobile phone left inside the vehicle may cause the vehicle interior monitoring alarm to trigger, as both sensors react to movements and shakes inside the vehicle.
- If on activating the alarm, any door or the rear lid is open, only the alarm will be activated. The vehicle interior monitoring and the anti-tow system will only be activated

once all the doors are closed (including the rear lid).

Doors

Introduction

The doors and rear lid can be locked manually and partially opened, for example if the key or the central locking is damaged.

WARNING

Opening and closing doors carelessly can cause serious injury.

- If the vehicle is locked from outside, the doors and windows cannot be opened from the inside.
- Never leave children or disabled people alone in the car. They could be trapped in the car in an emergency and will not be able to get themselves to safety.
- Depending on the time of the year, temperatures inside a locked and closed vehicle can be extremely high or extremely low resulting in serious injuries and illness or even death, particularly for young children.

WARNING

Getting in the way of the doors and the rear lid is dangerous and can lead to serious injury.

- Open and close the doors and the rear lid only when there is nobody in the way.

CAUTION

When opening and closing in an emergency, carefully disassemble components and then reassemble them carefully to avoid damage to the vehicle.

Emergency unlocking or locking of the driver's door

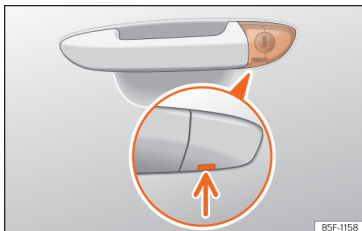


Fig. 89 Driver door handle: Concealed lock cylinder.

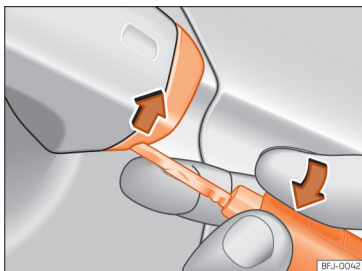


Fig. 90 Driver door handle: lever the cover off

If the central locking system should fail to operate, the driver door can still be locked and unlocked by turning the key in the lock.

As a general rule, when the driver door is locked manually all other doors are locked. When it is unlocked manually, only the driver door opens. Please observe the instructions relating to the anti-theft alarm system »» page 105.

- Unfold the vehicle key blade »» page 96.
- Insert the key shaft into the lower opening in the cover on the driver door handle »» Fig. 90 then remove the cover upwards.
- Insert the key blade into the lock cylinder to unlock or lock the vehicle.

Special characteristics

- The anti-theft alarm will remain active when vehicles are unlocked. However, the alarm will not be triggered »» page 105.
- After the driver door is opened, you have 15 seconds to switch on the ignition. Once this time has elapsed, the alarm is triggered.
- Switch the ignition on. The electronic immobilizer recognises a valid vehicle key and deactivates the anti-theft alarm system.

i Note

The anti-theft alarm is not activated when the vehicle is locked manually using the key shaft »» page 98.

Emergency lock of doors without lock cylinders



Fig. 91 Locking the door manually.

If the central locking system should fail to work at any time, doors with no lock cylinder will have to be locked separately.

The emergency lock is located on the front of the front passenger's door and the rear doors. It can only be seen if the door is open.

- Pull the cap out of the opening.
- Insert the key in the inside slot and turn it to the right as far as it will go (if the door is on the right side) or to the left (if the door is on the left side).
- Replace the cap.

Once the door has been closed it can no longer be opened from the outside. Pull the interior door handle once to unlock and open the door.

Childproof locks



Fig. 92 Childproof lock on the left hand side door.

The childproof lock prevents the rear doors from being opened from the inside. This system prevents minors from opening a door accidentally while the vehicle is running.

This function is independent of the vehicle electronic opening and locking systems. It only affects rear doors. It can only be activated and deactivated manually, as described below:

Activating the childproof lock

- Unlock the vehicle and open the door in which you wish to activate the childproof lock.
- With the door open, rotate the groove in the door using the ignition key, clockwise for the left hand side doors »» Fig. 92 and anti-clockwise for the right hand side doors.

Deactivating the childproof lock

- Unlock the vehicle and open the door whose childproof lock you want to deactivate.
- With the door open, rotate the groove in the door using the ignition key, anti-clockwise for the left hand side doors »» Fig. 92 and clockwise for the right hand side doors.

Once the childproof lock is activated, the door can only be opened from the outside.

Rear lid

Introduction

WARNING

Careless and unsuitable locking, opening and closing of the rear lid can cause accidents and serious injury.

- The rear lid must not be opened when the reverse or rear fog lights are lit. This may damage the tail lights.
- Do not close the rear lid by pushing it down with your hand on the rear window. The glass could smash. Risk of injury!
- Ensure the rear lid is locked after closing it. If not, it may open unexpectedly while driving.

- Closing the rear lid without observing and ensuring it is clear could cause serious injury to you and to third parties. Make sure that no one is in the path of the rear lid.

- Never drive with the rear lid open or half-closed, exhaust gases may penetrate into the interior of the vehicle. Danger of poisoning!

- Never leave the vehicle unattended or allow children to play inside or next to it, especially if the rear lid is open. Children could enter the luggage compartment, close the rear lid and become trapped. A locked vehicle can reach extremely high and low temperatures, depending on the time of year, thus causing serious injuries, illness or even death.

CAUTION

Before opening or closing the rear lid, make sure that there is enough space to open or close it, e.g. when pulling a trailer or in a garage.

Note



Before closing the rear lid, make sure that the key has not been left inside the luggage compartment.

Opening and closing the rear lid



Fig. 93 Rear lid: opening from outside.

The rear lid opening system operates electrically. It is activated by using the insignia shaped handle on the rear lid »» **Fig. 93**.

To lock or unlock the rear lid, press the  or  buttons of the vehicle key.

A warning appears on the instrument panel display if the rear lid is open or not properly closed.* An audible warning is also given if it is opened while the vehicle is moving faster than 6 km/h (4 mph)*.

Opening and closing

- To open: pull on the handle and lift it up »» **Fig. 93**. The rear lid opens automatically.
- Close: hold the gate by one of the handles fitted to the inner lining and close it by moving it downwards.

Emergency unlocking of the rear lid

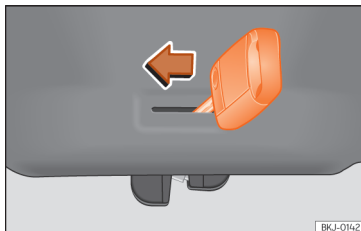


Fig. 94 Detail of the luggage compartment: emergency unlocking

The rear lid can be unlocked from inside in the event of an emergency (e.g. no battery).

There is a groove in the luggage compartment allowing access to the emergency opening mechanism.

Unlocking the rear lid from inside the luggage compartment

- Insert the key blade into the slot and move the key in the direction of the arrow until the lock unlocks »» **Fig. 94**.

Window controls

Electrically opening and closing the windows

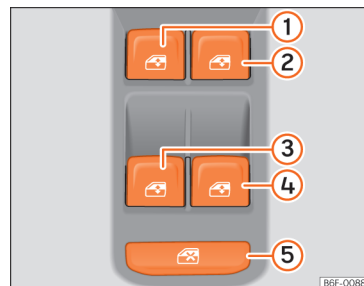




Fig. 95 Detail of the driver's door: window controls.

- Opening the window: press the button .
- Closing the window: pull the button .

Buttons on the driver door

- ① Window on the front left door
- ② Window on the front right door
- ③ Window on the rear left door*
- ④ Window on the rear right door*
- ⑤ Safety switch for deactivating the electric window buttons in the rear doors.*

The front and rear electric windows can be operated by using the controls on the driver door. The other doors each have a switch for their own window.

Always close the windows fully if you park the vehicle or leave it unattended »» » ⚠.


You can use the electric windows for approx. 10 minutes after switching off the ignition if neither the driver door nor the front passenger door has been opened and the key has not been removed from the ignition.

Safety switch *

The safety control »» » Fig. 95 ⑤ on the driver door can be used to disable the electric window buttons on the rear doors.

Safety switch not pressed: buttons on rear doors are activated.



Safety switch pressed: buttons on rear doors are deactivated.

The safety control symbol  lights up in yellow if the buttons on the rear doors are switched off.


Convenience open/close function

The electric windows can be opened or closed from outside using the vehicle key:


Convenience opening:

- Press and hold the  button on the remote control key until all the windows and the sunroof* have reached the desired position.
- **OR:** First unlock the vehicle using the  button on the remote control key and then keep the key in the driver door lock until all the windows and the sunroof* have reached the required position.

Convenience closing:

- Press and hold button  on the remote control key until all the windows and the sunroof* are closed »» » ⚠.
- **OR:** Keep the key in the driver door in the "lock" position until all the windows and the sunroof* are closed.

During convenience closing, first the windows and then the sliding sunroof will be closed.

Different settings can be changed using the Easy Connect system. Select: key **CAR** /  > **SETTINGS** > **Opening and closing** > **Window operation** > **Convenience opening**.

One-touch opening and closing

The one-touch automatic opening and closing is used to open or close the windows completely. It will not be necessary to hold the button of the corresponding electric window.

For the automatic raising function: pull the button for the corresponding window upwards until it reaches the second position.

For the automatic lowering function: pull the button for the corresponding window upwards until it reaches the second position.

Stop automatic movement: push or pull on the button of the corresponding window.


Resetting one-touch opening and closing

The one-touch opening and closing function is not active after the vehicle battery has been disconnected or is flat and will have to be reset.

- Pull the button of the corresponding window and hold it for one second in this position.
- Release the button and pull upwards and hold again. The one-touch function is now ready for operation.

The automatic one-touch electric windows can be reinitialised individually or several at a time.

WARNING

Observe the safety warnings »» »  in Introduction on page 107.

- **Incorrect use of the electric windows can result in injury.** »»

- Never close the rear lid without observing and ensuring it is clear, to do otherwise could cause serious injury to you and third parties. Make sure that no one is in the path of a window.
- If the ignition is switched on, the electric equipment could be activated with risk of injury, for example, in the electric windows.
- The doors can be locked using the remote control key. This could become an obstacle for assistance in an emergency situation.
- Therefore always take the key with you when you leave the vehicle.
- The electric windows will work until the ignition has been switched off and one of the front doors has been opened.
- If necessary, use the safety switch to disable the rear electric windows. Make sure that they have been disabled.
- For safety reasons, you should only use the remote control open and close functions within about 2 metres of the vehicle. To avoid injuries, always keep an eye on the windows when pressing the button to close them. The windows stop moving as soon as the button is released.


Note

If the window is not able to close because it is stiff or because of an obstruction, the window will automatically open again »» page 112. If this happens, check why the


window could not be closed before attempting to close it again.

Window anti-trap function

The roll-back function reduces the risk of injury when the electric windows close.

- If a window is obstructed when closing automatically, the window stops at this point and lowers immediately »» .
- Next, check why the window does not close before attempting it again.
- If you try within the following 10 seconds and the window closes again with difficulty or there is an obstruction, the automatic closing will stop working for 10 seconds.
- If the window is still obstructed, the window will stop at this point.
- If there is no obvious reason why the window cannot be closed, try to close it again by pulling the tab within ten seconds. The window closes with maximum force. **The roll-back function is now deactivated.**
- If more than 10 seconds pass, the window will open fully when you operate one of the buttons. One-touch closing is reactivated.

WARNING

Observe the safety warnings »»  in Electrically opening and closing the windows on page 111.

- The roll-back function does not prevent fingers or other parts of the body getting pinched against the window frame. Risk of accident.

Sunroof*

Introduction

The sunroof only works when the ignition is switched on. Once the ignition has been switched off, you can still open or close the sunroof for a few minutes provided the driver door and the front passenger door are not opened.

WARNING

If the sunroof is used negligently or without paying due attention, it can cause serious injury.

- Open or close the sunroof and the sun blind only when no one is in their path of movement.
- Never leave any key inside the vehicle when exiting.
- Never leave a child or any other person who may need help in the vehicle,

especially if they have access to the vehicle key. If using the key unattended, they could lock the vehicle, start the engine, switch on the ignition and activate the sunroof.

- After switching off, it is still possible to open or close the sunroof during a short space of time provided that neither the driver nor passenger door is opened.

ⓘ CAUTION

- To prevent damage, during winter temperatures remove any ice or snow that might be on the car roof before opening the sunroof or adjusting the tilt position.
- Before leaving the vehicle or in case of rainfall, always close the sunroof. With the sunroof open or in a tilted position, water can enter the interior and can cause considerable damage to the electrical system. As a result, other damage can occur in the vehicle.

ⓘ Note

- Leaves and other loose objects that accumulate on the sunroof rails should be regularly cleaned away either by hand or with a vacuum.
- If the sunroof does not work correctly, the anti-trap function will not work either. Contact a specialised workshop.

Opening and closing the sunroof

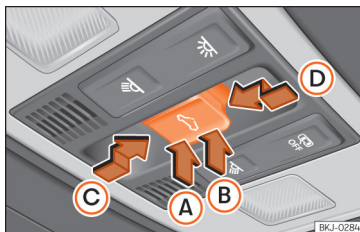


Fig. 96 On the interior roof lining: sunroof button.

The ⇄ button ⇄ **Fig. 96** has two levels. The first level switches the sunroof to the tilted position, opening or closing it fully or partially.

On the second level, the sunroof automatically moves to the corresponding final position after briefly pressing the button. Activating the button again stops the automatic function.

Adjusting the tilt position of the sunroof

- Press the rear part of the button **(B)** to the first level.
- Automatic function: briefly press the rear part of button **(B)** to the second level.

Closing the sunroof from a tilted position

- Press the front part of the button **(A)** to the first level.
- Automatic function: briefly press the front part of the button **(A)** to the second level.

Stopping the automatic operation by adjusting the tilted position of the sunroof or by closing the sunroof

- Press button **(A)** or **(B)** again.

Opening the sunroof

- Press button **(C)** backwards to the first level.
- Automatic function to the comfort position: briefly press button **(C)** backwards to the second level.

Closing the sunroof

- Press button **(D)** forwards to the first level.
- Automatic function: briefly press button **(D)** forwards to the second level.

Stopping the automatic operation during the opening or closing

- Press button **(C)** or **(D)** again.

Sun blind

The sun blind is opened and closed manually (independently of the sliding sunroof).

Convenience function to open or close the sunroof*

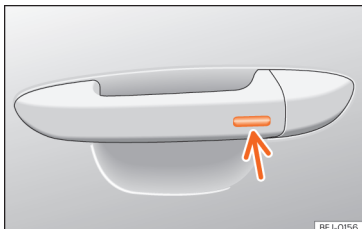


Fig. 97 Door handle: sensor surface.

The sunroof can be opened and closed with the convenience function, just like the windows.

Using the door lock*

- Hold the key in the door lock of the driver door in either the unlocking or locking position to open or close the roof in the tilted position. Release the key to interrupt this function.

Using the remote control

- Keep the locking or unlocking button pressed to open or close the roof. If you release the button the opening or closing will stop.

Once all the windows and the sunroof have closed, all the turn signals flash. During con-

venience closing, the windows and the sunroof close at the same time.

Using the Keyless Access* system (only closing)

- Press and hold the locking sensor surface »» Fig. 97 (arrow) on the door handle to close the sunroof. If you release the sensor surface, the closing movement stops.

Anti-trap function of the panoramic sunroof

The anti-trap function can reduce the risk of injury when closing the sunroof »» ⚠. If the sunroof encounters resistance or an obstacle when closing, it reopens immediately.

- Check why the sunroof did not close.
- Try to close the sunroof again.
- If the sunroof cannot be closed due to an obstacle or some resistance, it stops at the corresponding position and then reopens. For automatic closing, a new closing attempt might take place.
- If the sunroof is still unable to close, close it without the anti-trap function.

Closing the sunroof without the anti-trap function

- Within approximately 5 seconds of having activated the roll-back function, press the ⇐ »» Fig. 96 button to the second level in the direction of arrow »» Fig. 96 Ⓧ until the sunroof closes completely.
- **The sunroof closes without the anti-trap function intervening!**
- If the sunroof will still not close, visit a specialised workshop.

⚠ WARNING






Closing the sunroof without the anti-trap function can cause serious injuries.

- **Always be careful when closing the sunroof.**
- **No person should ever remain in the way of the sunroof, especially when closing without the anti-trap function.**
- **The anti-trap function does not prevent fingers or other parts of the body from becoming trapped against the roof frame and injuries occurring.**

Lights

Vehicle lighting

Control lamps

 It lights up
Driving light totally or partially faulty.
Fault in the cornering light system.
 It lights up
Rear fog light switched on » page 117.
 It lights up
Left or right turn signal. The control lamp flashes twice as fast when a turn signal is faulty.
Hazard warning lights on » page 119.
 It lights up
Trailer turn signals
 It lights up
Main beam on or flasher on » page 117.

Several warning and control lamps light up for a few seconds when the ignition is switched on, signalling that the function is being

verified. They will switch off after a few seconds.

WARNING

Observe the safety warnings »  in Control and warning lamps on page 85.

Headlight switch

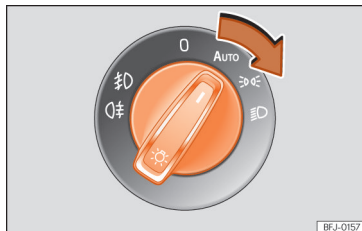




Fig. 98 Dash panel: lights control.

- Turn the switch to the required position » **Fig. 98.**


Sym- bol	Ignition switch- ed off	Ignition is switched on
0	Fog lights, dipped beam and side lights off.	Light off or day-time driving light on

Sym- bol	Ignition switch- ed off	Ignition is switched on
AUTO	The “Coming home” and “Leaving home” guide lights may be switched on.	Automatic control of dipped beam and daytime running light.
	Side light on.	Daylight running lights switched on.
	Dipped beam headlight off	Dipped beam switched on.

The driver is personally responsible for the correct use and adjustment of the lights in all situations.

Automatic dipped beam headlight control **AUTO***

The automatic dipped beam control is merely intended as an aid and is not able to recognise all driving situations.


When the light switch is in position **AUTO**, the vehicle lights and the instrument panel and switch lighting switch on automatically in the following situations » :

- The photo sensor detects *darkness*, for example, when driving through a tunnel. They switch off when adequate lighting is detected.

»

- The rain sensor detects rain and activates the wipers. They switch off when the wipers have not been activated for a few minutes.

Daytime running lights

The daytime running lights consist of individual lights, integrated in the front headlights. These lights come on when the daytime running lights are switched on. On vehicles equipped with LED tail lights, the rear side light is switched on as well .

The daytime running lights turn on every time the ignition is switched on, if the switch is in position **0** or **AUTO**, according to the level of exterior lighting.

When the light switch is in position **AUTO**, a light sensor automatically switches dipped beam on and off (including the control and instrument lighting) or the daytime running lights depending on the level of exterior lighting.

Motorway light*

The motorway light is available on vehicles equipped with full-LED lights.




The function is connected and disconnected via the corresponding Easy Connect system menu.

- **Activation:** when going above 110 km/h (68 mph) for more than 10 seconds, the dipped beam raises slightly to increase the driver's visibility distance.

- **Deactivation:** when reducing the speed of the vehicle below 100 km/h (62 mph), the dipped beam immediately returns to its normal position.

Audible warnings to advise the driver that the lights have not been switched off

If the key is not in the ignition and the driver door is open, an audible warning signal is heard in the following cases: this will remind you to turn the light off.

- When the parking light is on  page 117.
- When the light switch is in position  or .

WARNING

If the road is not well lit and other road users cannot see the vehicle well enough or at all, accidents may occur.

- The automatic dipped beam control (**AUTO**) only switches on the dipped beam when there are changes in light conditions but not, for example, when it is foggy.

WARNING

The side lights or daytime running lights are not bright enough to illuminate the road ahead and to ensure that other road users are able to see you.

- Always use your dipped beam headlights if it is raining or if visibility is poor.

- Never drive with daytime lights if the road is not well lit due to weather or lighting conditions.

- On vehicles with rear lights with bulbs, when activating the daytime running light the rear lights are not switched on. A vehicle which does not have the rear lights on may not be visible to other drivers in the darkness, in the case of heavy rain or in conditions of poor visibility.

WARNING

If the headlights are set too high and not used correctly, there is a risk of dazzling or distracting other road users. This could result in a serious accident.

- Always make sure that the headlights are correctly adjusted.

Note

- The legal requirements regarding the use of vehicle lights in each country must be observed.
- The dipped beam headlights will only work with the ignition on. The side lights come on automatically when the ignition is turned off.

Fog lights



Fig. 99 Dash panel: lights control.

The warning lamps ⊘ or ⊘ also show, on the light switch or instrument panel, when the front fog lights are on.

- **Turning on the front fog lights* ⊘:** pull the light switch out to its first click position » **Fig. 99** ①, from positions ⊘, ⊘ or **AUTO**.
- **Turning on the rear fog light ⊘:** pull the light switch fully out ② from position ⊘, ⊘ or **AUTO**. This control has only one position in vehicles without fog lights.
- To switch off the fog lights, press the light switch or turn it to position 0.

Note

The rear fog light can dazzle drivers behind you. You should use the rear fog light only when visibility is very poor.

Turn signal and main beam lever

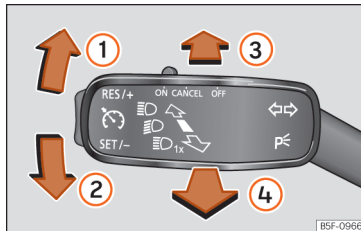


Fig. 100 Turn signal and main beam lever.

Move the lever to the required position:

- ① Right turn light or right-hand parking light (ignition switched off).
- ② Left turn light or left-hand parking light (ignition switched off).
- ③ Main beam on: control lamp ⊘ lit up on the instrument panel.
- ④ Light flash: on with the lever pushed. Control lamp ⊘ lit up.

Push the lever all the way down to turn off the corresponding function.

Convenience turn signals

When the ignition is switched on, move the lever as far as possible upwards or downwards and release the lever. The turn signal will flash three times.

Convenience turn signals are turned on and off in the Easy Connect system using the button **CAR / ⚙** **SETTINGS > Lighting > Light assistance > Convenience turn signals** » page 90.

In vehicles that do not have the corresponding menu, this function can be deactivated in a specialised workshop.

Parking light P

The parking lights will only work with the ignition off. If said light is on, an audible warning will sound while the driver door is open.

- Switch the ignition off.
- Move the turn signal lever up or down.

When the parking light is switched on, the front side light and the tail light on the corresponding side of the vehicle turn on.

WARNING

Improper or lack of use of the turn signals, or forgetting to deactivate them can confuse other road users. This could result in a serious accident.

- Always give warning when you are going to change lane, overtake or when turning, activating the turn signal in good time.
- As soon as you have finished changing lane, overtaking or turning, switch the turn signal off.

»

⚠ WARNING

Incorrect use of the headlights may cause accidents and serious injury, as the main beam may distract or dazzle other drivers.

i Note

- If the turn signal lever is left on after the key has been taken out of the ignition lock, an acoustic signal sounds when the driver door is opened. This is intended as a reminder to switch off the turn signal, unless you wish to leave the parking light on.
- If the convenience turn signals are operating (three flashes) and the other convenience turn signals are switched on, the active part stops flashing and only flashes once in the new part selected.
- The turn signal only works when the ignition is switched on. The hazard warning lights also work when the ignition is switched off.
- If a trailer turn signal malfunctions, the control lamp will stop flashing (trailer turn signals) and the vehicle turn signal will flash at double speed.
- The main beam headlights can only be switched on if the dipped beam headlights are already on.
- In cold or damp weather conditions, the headlights, tail lights and turn signals may mist up inside temporarily. This is normal and in no way effects the useful life of the vehicle lighting system.

- The parking light does not activate automatically if the left- or right-hand turn signal is left on and the ignition is disconnected.

Fog lights with cornering light function*

✓ Not available on vehicles equipped with full-LED headlights and bulb fog lights.

The *cornering* light function is an additional function to the dipped beam headlights to improve lighting of the side of the road when taking a sharp turn at low speed.

The *cornering* light function works when the dipped beam headlights are already on and it is activated when driving at speeds below approximately 40 km/h (25 mph).

- If the steering wheel is turned or the turn signal is switched on, the front fog light gradually turns on. After the turn, the *cornering* light function is gradually switched off.
- When engaging reverse gear, both front fog lights turn on.

“Coming home” and “Leaving home” function

The “Coming home” and “Leaving home” function lights up the vehicle’s immediate proximity when getting into and out of it in the dark. When switched on, the front position and dipped beam lights, tail lights and license plate light come on.

The “Leaving Home” is controlled by a photo-sensor.

In the vehicle settings menu of the infotainment system you can adjust the duration of the light switch-off delay, and activate and deactivate the function.

Activating the “Coming Home” function

For vehicles with light and rain sensors.

- Switch off the engine and remove the key from the ignition with the light switch in position **AUTO** » page 115.
- The automatic “Coming Home” function is only active when the light sensor detects darkness.

For vehicles without light and rain sensors.

- Switch the ignition off.
- Activate the headlight flashers for *approximately 1 second*.

When the driver door is opened, the “Coming Home” lighting comes on. The *delay in*

switching off the headlights is counted from when the last door or boot hatch is closed.

The “Coming Home” lighting turns off in the following cases:

- Automatically, once the headlight turn off delay has elapsed.
- Automatically, when a vehicle door or the rear lid is still open 30 seconds after starting the engine.
- When the rotary light switch is turned to position 0 »»» page 115.
- With the ignition is switched on.

Activating the “Leaving Home” function

- Unlock the vehicle using the remote control.
- The “Leaving Home” function is only activated when the light switch is in position **AUTO** and the light sensor detects darkness.

The “Leaving Home” lighting switches off in the following cases:

- Automatically, when the “Leaving Home” delay period ends (default 30 sec).
- When the vehicle is locked using the remote control.
- When the light switch is turned to position 0.
- With the ignition is switched on.

Note

To activate the “Coming Home” and “Leaving Home” function, the rotary light switch must be in position **AUTO** and the light sensor must detect darkness.


Hazard warning lights






Fig. 101 Dash panel: hazard warning lights switch

The hazard warning lights are used to draw the attention of other road users to your vehicle in emergencies.

If your vehicle breaks down:

1. Park your vehicle at a safe distance from moving traffic.
2. Press the button to switch on the hazard warning lights »»» .
3. Switch the ignition off.

4. Apply the handbrake.
5. For a manual gearbox, engage 1st gear; for an automatic gearbox, move the gear lever to **P**.
6. Use the warning triangle to draw the attention of other road users to your vehicle.
7. Always take the vehicle key with you when you leave the vehicle.

All turn signals flash simultaneously when the hazard warning lights are switched on. The two turn signal turn signal lamps   and the turn signal lamp in the switch  will flash at the same time. The simultaneous hazard warning lights also work when the ignition is switched off.

Emergency braking warning

If the vehicle brakes suddenly and continuously at a speed of more than 80 km/h (50 mph), the brake light flashes several times per second to warn the vehicles driving behind. If you continue braking, the hazard warning lights will come on automatically when the vehicle comes to a standstill. They switch off automatically when the vehicle starts to move again.

WARNING

- The risk of an accident increases if your vehicle breaks down. Always use the hazard warning lights and a warning triangle to »

draw the attention of other road users to your stationary vehicle.

- Due to the high temperatures that the catalytic converter can reach, never park in an area where the catalytic converter could come into contact with highly inflammable materials, for example dry grass or spilled petrol. This could start a fire.

Note

- The battery will run down if the hazard warning lights are left on for a long time, even if the ignition is switched off.
- The use of the hazard warning lights described here is subject to the relevant statutory requirements.

Light range control



Fig. 102 Next to the steering wheel: headlight range control.

The headlight range control »» Fig. 102 is modified according to the value of the headlight beam and the vehicle load status. This offers the driver optimum visibility and the headlights do not dazzle oncoming drivers »» ⚠.

The headlights can only be adjusted when the dipped beam is switched on.

To reset, turn switch »» Fig. 102:

Value	Vehicle load status ^{a)}
–	Two front occupants, luggage compartment empty
1	All seats occupied, luggage compartment empty
2	All seats occupied, luggage compartment full. With trailer and minimum drawbar load.
3	Driver only, luggage compartment full. With trailer and maximum drawbar load.

^{a)} If the vehicle load does not correspond to those shown in the table, it is possible to select intermediary positions.

Dynamic headlight range control

The control is not mounted in vehicles with dynamic headlight range control. The headlight range is automatically adjusted according to the vehicle load status when they are switched on.

⚠ WARNING

Heavy objects in the vehicle may mean that the headlights dazzle and distract other drivers. This could result in a serious accident.

- Adjust the light beam to the vehicle load status so that it does not blind other drivers.

Driving abroad

The light beam of the dipped beam lights is asymmetric: the side of the road on which you are driving is lit more intensely.

When a car that is manufactured in a country that drives on the right travels to a country that drives on the left (or vice versa), it is normally necessary to cover part of the headlight bulbs with stickers or to change the adjustment of the headlights to avoid dazzling other drivers.

In such cases, the regulations specify certain light values that must be complied with for designated points of the light distribution. This is known as “Tourist light”.


The light distribution of the halogen and full-LED headlights allows the specific “tourist light” values to be met without the need for stickers or changes in the settings.

Note

"Tourist light" is only allowed temporarily. If you are planning a long stay in a country that drives on the other side, you should take the vehicle to an Authorised Technical Service to change the headlights.

Interior lights

Lighting of the instrument panel, displays and switches

Depending on the model, the instrument cluster and controls lighting can be adjusted in the Easy Connect system, using the button **CAR** /  > **SETTINGS** > **Lighting** > **Interior Lighting**» page 90.

With the ignition on and without light activation, the analogue instrument panel lighting remains activated in daytime light conditions. The lighting is reduced as the exterior light diminishes. In some cases, e.g. when driving through a tunnel without the **AUTO** function active, the instrument panel lighting may even switch off. The objective of this function is to provide the driver with a visual indication that he or she should activate the dipped beam.

If your vehicle is equipped with a digital instrument panel (Digital SEAT Cockpit), the

following message will appear **Turn on the Lights** on the instrument panel.

Interior and reading lights

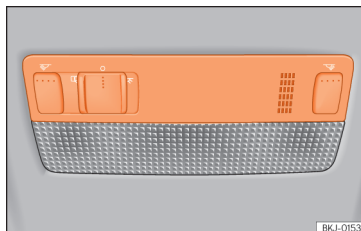






Fig. 103 Detail of roof lining: front lighting of the passenger compartment.

Knob	Function
	Turns off the interior lights.
	Turning the interior lights on or off.
	The interior lights come on automatically when you unlock the vehicle, open a door or remove the key from the ignition. The light goes out a few seconds after closing all the doors, when locking the vehicle or connecting the ignition.
	Turning the reading light on and off


The light controls may vary depending on the vehicle version.


Luggage compartment lighting

The light is activated when the rear lid is open, even when the ignition and lights are turned off. For this reason, ensure that the rear lid is always closed.

Ambient light*

The ambient light lights up the area of the centre console and the footwell area and, depending on the version, the front door panels as well.

It will be switched on at full brightness when the doors are opened and the lights will be dimmed during driving, when the light selector is set to  or **AUTO**.

The brightness of the ambient light can be adjusted through the Easy Connect menu. The colour can also be changed in versions with lighting on the front door panel (button **CAR** /  > **SETTINGS** > **Ambient Lighting**» page 86).

Note

If not all the vehicle doors are closed, the interior lights will be switched off after approx. 10 minutes, providing the ignition key has been removed and the courtesy light position selected. This prevents the battery from discharging.

Visibility

Windscreen wiper and rear window wiper systems

Window washer lever

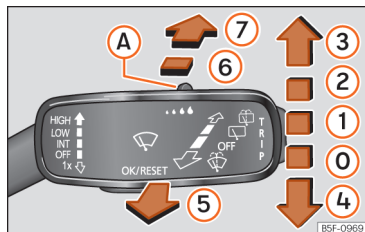


Fig. 104 Operating the windscreen wiper and rear wiper.

More the lever to the required position:

0	OFF	Windscreen wipers off.
1	INT	Wiper intervals. Use control »» Fig. 104 A to set the interval (vehicles without rain sensor), or the sensitivity of the rain sensor.
2	LOW	Slow wipe.
3	HIGH	Continuous wipe.

More the lever to the required position:

4	1x	Short wipe. Brief press, short clean. Hold the lever down for more time to increase the wipe frequency.
5		Windscreen washer. The windscreen washer function is activated by pushing the lever towards the steering wheel, and the wipers operate simultaneously.
6		Interval wipe for rear window. The wiper will wipe the window approximately every six seconds.
7		The rear window wash function is activated by pressing the lever, and the rear wiper starts simultaneously.

WARNING

In cold conditions you should not use the wash/wipe system unless you have warmed the windscreen with the heating and ventilation system. The windscreen washer fluid could otherwise freeze on the windscreen and obscure your view of the road.

CAUTION

If the ignition is switched off with the windscreen wipers active, they complete their wipe before returning to the rest position. When switching the ignition back on, the windscreen wiper will continue to operate at the same wiping level. Ice, snow and oth-

er obstacles on the windscreen may damage the wiper and the windscreen wiper motor.

- If necessary, remove snow and ice from the windscreen wipers before starting your journey.
- Carefully lift the frozen windscreen wipers from the glass. SEAT recommends a de-icer spray for this operation.
- Do not switch on the windscreen wipers if the windscreen is dry. Cleaning with the windscreen wipers while dry can cause damage.
- In icy conditions, always check that the wiper blades are not frozen to the glass before using the wipers. In cold weather, it may help to leave the vehicle parked with the wipers in service position »» page 48.

Note

- The windscreen and window wipers only function when the ignition is switched on and the bonnet or rear lid, respectively, are closed.
- The interval wipe speed varies according to the vehicle speed. The faster the vehicle is moving, the more often the windscreen is cleaned.
- The rear wiper is automatically switched on when the windscreen wiper is on and the car is in reverse gear.

Wiper functions

Windscreen wipers performance in different situations

- If the vehicle is stopped, the activated position temporarily moves to the previous position.
- The air conditioner comes on for approximately 30 seconds in air recirculation mode when the windscreen washer is activated, to prevent the smell of the windscreen washer fluid entering the inside the vehicle.
- When wiping at intervals, the intervals vary according to the speed. The higher the vehicle speed the shorter the intervals.

Note

- The wiper will try to wipe away any obstacles that are on the windscreen. The wiper will stop moving if the obstacle blocks its path. Remove the obstacle and switch the wiper back on again.
- If you stop the vehicle with the windscreen wiper in position 1 or 2, it will automatically change to a lower position speed. The set speed will be resumed when the vehicle pulls away.
- The windscreen will be wiped again approximately 5 seconds after the windscreen washer has been activated, provided the vehicle is moving ("drip" function). If you activate the wipers less than 3 seconds after the "drip" function, a new wash

sequence will begin without performing the last wipe. For the "drip" function to work again, you have to turn the ignition off and then on again.

Rain sensor*

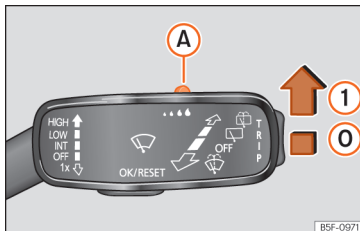


Fig. 105 Wiper lever: adjust the rain sensor

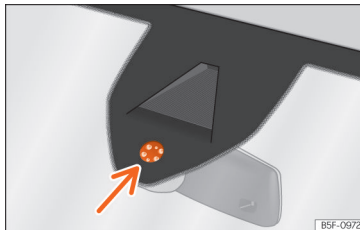


Fig. 106 Rain sensor sensitive surface

The rain sensor controls the frequency of the windscreen wiper intervals, depending on the amount of rain »» » Δ . The sensitivity of the rain sensor can be adjusted manually. Manual wipe »» » page 122.

Move the lever to the required position »» » Fig. 105:

- Rain sensor off.
- ① Rain sensor on; automatic wipe if necessary.
- Ⓐ Setting sensitivity level of rain sensor
 - Set control to the right: high sensitivity.
 - Set control to the left: low sensitivity.

When the ignition is switched off and then back on, the rain sensor stays on and starts operating again when the windscreen wipers are in position ① and the vehicle is travelling at more than 16 km/h [10 mph].

Modified behaviour of the rain sensor

Possible causes of faults and mistaken readings on the sensitive surface »» » Fig. 106 of the rain sensor include:

- Damaged wipers: a film of water on the damaged blades may lengthen the activation time, reduce the washing intervals or result in a fast and continuous wipe.
- Insects: insects on the sensor may trigger the windscreen wiper.

»

- Salt on the road: in winter, salt spread on the roads may cause an excessively long wipe when the windscreen is almost dry.
- Dirt: dry dust, wax, coating on glass (Lotus effect) or traces of detergent (car wash) may reduce the effectiveness of the rain sensor or make it react more slowly, later or not at all.
- Windscreen crack: the impact of a stone will trigger a single wipe cycle with the rain sensor on. Next the rain sensor detects the reduction in the sensitive surface area and adapts accordingly. The behaviour of the sensor will vary with the size of the damage caused by the stone.

WARNING

The rain sensor may not detect enough rain to switch on the wipers.

- If necessary, switch on the wipers manually when water on the windscreen obstructs visibility.

Note

- Clean the sensitive surface of the rain sensor regularly and check the blades for damage »» Fig. 106 [arrow].
- To remove wax and coatings, we recommend a window cleaner containing alcohol.
- Do not put stickers on the windscreen in front of the rain sensor*. This may cause sensor disruption or faults.

Mirrors

Interior mirror anti-dazzle function

Rear view mirror with automatic anti-dazzle function*

The anti-dazzle function is activated every time the ignition is switched on.

When the anti-dazzle function is enabled, the interior rear vision mirror will darken **automatically** according to the amount of light it receives. The anti-dazzle function is cancelled if reverse gear is engaged.

WARNING

In the event that an automatic anti-dazzle rear vision mirror breaks, an electrolyte fluid may leak. This could cause irritation to the skin, eyes and respiratory organs. If you come into contact with this liquid, it must be rinsed with large quantities of water. If necessary, get medical help.

CAUTION

In the event that an automatic anti-dazzle rear vision mirror breaks, an electrolyte fluid may leak. This liquid attacks plastic surfaces. Clean it with a wet sponge as soon as possible.

Note

- If the light incident in the interior rear vision mirror is obstructed (e.g. with the sun blind*), the anti-dazzle rear vision mirror with automatic setting will not operate perfectly.
- When the interior lights are on or reverse gear engaged, the mirrors do not darken with automatic adjustment for anti-dazzle position.
- If you have to stick any type of sticker on the windscreen, do not do so in front of the sensors. Doing so could prevent the anti-dazzle function from working well or even from working at all.

Manually folding the exterior mirrors

The exterior mirrors of the vehicle may be folded in. For this, press the mirror housing towards the vehicle.

Note

Before washing the vehicle with an automatic car wash, fold in the exterior mirrors to avoid damage.

Adjusting the exterior mirrors

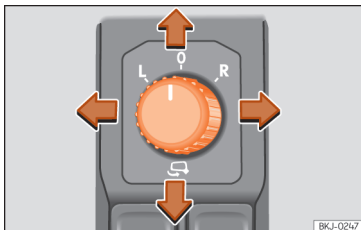



Fig. 107 Detail of the driver's door: control for the exterior mirror.

Turn the control to the corresponding position:

L/R Turning the knob to the desired position, adjust the mirrors on the driver side (L, left) and the passenger side (R, right) to the direction desired.


 Folding in mirrors.

Heated exterior mirrors*

- Press the demisting switch  next to the air conditioning controls **>>> page 140**.
- The mirrors demist for some minutes to prevent draining the battery unnecessarily.
- If necessary, press the button again to repeat the function.

- The exterior mirror heating is not activated in temperatures above approximately +20°C [+68°F].

Fold the rearview mirrors when locking the vehicle*

The Easy Connect system button **CAR /  > SETTINGS > Mirrors and wipers > Mirrors** can be used to select whether the outside mirrors fold in when the vehicle is parked and locked **>>> page 86**.

When the vehicle is locked with the remote control, the exterior mirrors are retracted automatically. When the vehicle is opened with the remote control, the exterior mirrors are deployed automatically.

WARNING

Convex or wide-angle* exterior mirrors give a larger field of vision. However, they make objects look smaller and further away than they really are. If you use these mirrors to estimate the distance to vehicles behind you when changing lane, you could misjudge the distance. Risk of accident!

WARNING

Fold and unfold the exterior mirror, taking care to avoid injuries.

- Only fold or unfold the exterior mirror when there is no-one in the way of the mirror.

- When moving the mirror, take care not to trap fingers between the mirror and the mirror bracket.

CAUTION

- If one of the mirror housings is knocked out of position (e.g. when parking), the mirrors must first be fully retracted with the electric control. Do not readjust the mirror housing by hand, as this will interfere with the mirror adjuster function.
- Before washing the vehicle in an automatic car wash, please make sure to retract the exterior mirrors to prevent them from being damaged. Electrically retractable exterior mirrors must not be folded in or out by hand. Always use the electrical power control.

Note

- If the electrical adjustment should fail to operate, both of the mirrors can be adjusted by hand by lightly pressing the edge of the mirror glass.
- The fold-in function on the exterior mirrors will not activate at speeds over 40 km/h [25 mph].

Sun protection

sun blind

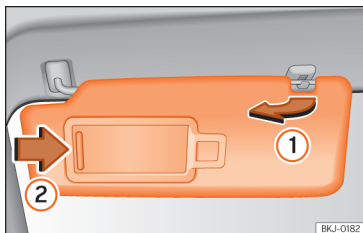


Fig. 108 Sun visor on the driver side.

Options for adjusting driver and front passenger sun visors

- Lower the sun visor towards the wind-screen.
- The sun visor can be pulled out of its mounting and turned towards the door »» Fig. 108 ①.
- Swing the sun visor towards the door, longitudinally backwards.

There is a vanity mirror on the sun visor, with a cover ②.

⚠ WARNING

Folded sun blinds can reduce visibility.

- Always store sun blinds and visors in their housing when not in use.

Seats and headrests

Adjusting seats

Manual adjustment of the front seats

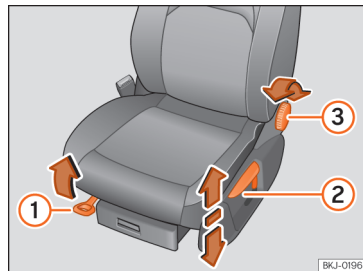


Fig. 109 Front seats: manual seat settings.

- ① Forwards/backwards: pull the lever and move the seat. The seat must engage when the lever is released!
- ② Raise/lower: pull the lever up or push down (several times if necessary) from its home position.
- ③ Tilting the backrest: turn the hand wheel.

⚠ WARNING

Incorrect seat adjustment may lead to accidents and severe injuries.

- Only adjust the seats when the vehicle is stationary, as the seats could move unexpectedly while the vehicle is in motion and you could lose control of the vehicle. Furthermore, an incorrect position is adopted when adjusting the seat.
- Adjust the height, position and inclination of the front seats only when their movement area is empty.
- Make sure there are no objects in that area.
- Make sure that the movement and locking areas of the seats are clean.

Headrest

Introduction

The possibilities for the adjustment and disassembly of the headrests are described below. Always make sure that the seats are correctly adjusted »» page 13.

All seats are equipped with a headrest. The central rear headrest is only intended for the central seat of the rear bench. Therefore, do not install it on any other seat.

Correct adjustment of headrest

Adjust the headrest so that its upper edge is at the same level as the top of your head and under no circumstances below eye level.

Keep the back of your head always as close to the headrest as possible.

Adjusting the headrest for short people

Lower the headrest completely, even if your head is below its upper edge. In the lowest position, there may be a small distance between the headrest and the backrest.

Adjusting the headrest for tall people

Push the headrest up as far as it will go.

⚠ WARNING

If travelling with the headrests removed or improperly adjusted, the risk of severe or fatal injuries in the event of accidents and sudden braking or manoeuvres increases.

- Always travel with the headrest correctly installed and adjusted.
- To decrease the risk of cervical injuries in the event of an accident, adjust the headrest correctly based on your height, always making sure that its upper edge is at the same height as the top of the head, but never below eye level. Keep the back of your head always as close to the headrest as possible and centred.
- Never adjust the headrest while the vehicle is in motion.
- Under no circumstances should the rear passengers travel while the headrests are in the non-use position.

ⓘ CAUTION

When assembling and disassembling the headrests, do not let them meet the top lining of the vehicle, the back rest of the front seat or other parts of the vehicles. If not, this could damage the vehicle.

Adjusting the headrests

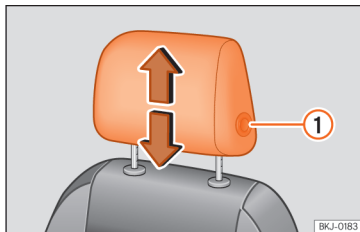


Fig.110 Front seat: headrest adjustment.

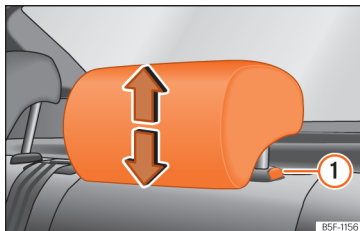


Fig.111 Rear headrest: headrest adjustment.

Adjusting the height of the headrests

- Move the headrest up or down in the direction of the corresponding arrow. Regarding the rear headrest, to both raise and lower, press the button »» Fig. 110 ①; for the rear headrests it is only necessary to press the button »» Fig. 111 ① to lower them »» ⚠ in Introduction on page 127.
- The headrest must lock correctly in one position.

Removing and fitting the headrests

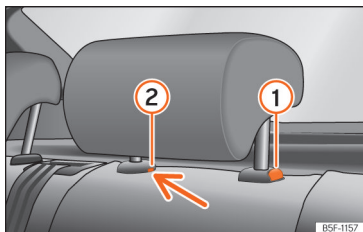


Fig. 112 Rear headrest: removal.

Removing and fitting the front headrests

- Move the headrest upwards until it arrives to the top.
- Press the side button »» Fig. 110 ① and remove the headrest.

- To refit, insert the headrest into the holes in the backrest, pushing it down until it engages.

Removing the rear headrests

To remove the headrest, the corresponding backrest must be partially folded forward.

- Unlock the backrest »» page 128.
- Move the headrest upwards until it arrives to the top.
- Press button »» Fig. 112 ①, while simultaneously pressing on the security hole ② with a flat screwdriver a maximum of 5 mm wide, and remove the headrest.
- Move the backrest until it engages properly »» ⚠ in Folding down and raising the rear seat backrest on page 129.

Fitting the rear headrests

To mount the external headrests, the corresponding backrest must be partially folded forward.

- Unlock the backrest »» page 128.
- Insert the headrest bars into the guides until they perceptibly engage. It should not be possible to remove the headrest from the backrest.
- Move the backrest until it engages properly »» ⚠ in Folding down and raising the rear seat backrest on page 129.

⚠ WARNING

Remove the rear headrests only when it is necessary to fit a child seat. After removing a child seat, refit the headrest immediately.

Seat functions

Folding down and raising the rear seat backrest

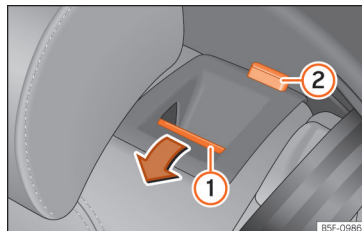


Fig. 113 Rear seat: folding the backrest.

On split rear seats*, the backrest can be lowered in two sections.

Folding the backrest forwards

- Completely lower the rear headrests »» page 127.
- Press the unlock button »» Fig. 113 ① forwards and at the same time fold the backrest

down. The rear seat backrest is not engaged when the red marking of the button ② is visible.

Converting the table to a seat

• Raise and lock in the back rest. The red marking on the tab ② should no longer be visible when the backrest is properly secured.

⚠ WARNING

Serious injuries can be caused if the rear seat backrest is lowered or lifted without due care and attention.

- Never lower or lift the rear seat backrest while driving.
- Do not trap or damage the seat belt when raising the rear seat backrest.
- When lowering or lifting the rear seat backrest, keep your hands, fingers, feet and other body parts out of its path.
- For the rear seat belts to offer the necessary protection all the parts of the rear backrest must be properly engaged. This is particularly important in the case of the centre rear seat. If someone is seated in a seat whose backrest is not properly engaged they will fly forward, along with the backrest, during an accident or a sudden driving or braking manoeuvre.
- A red signal on the button ② warns that the backrest is not engaged. Always check that the red marking is not visible when the backrest is in the upright position.

- When the rear seat backrest is lowered or is not properly engaged nobody else can travel in the corresponding seats (not even a child).

⚠ CAUTION

Serious damage can be caused to the vehicle and other objects if the rear seat backrest is lowered or lifted without due care and attention.

- Before lowering the rear seat backrest, always adjust the front seats so that neither the headrests nor the cushions of the rear backrest can hit them.

Removable seat covers

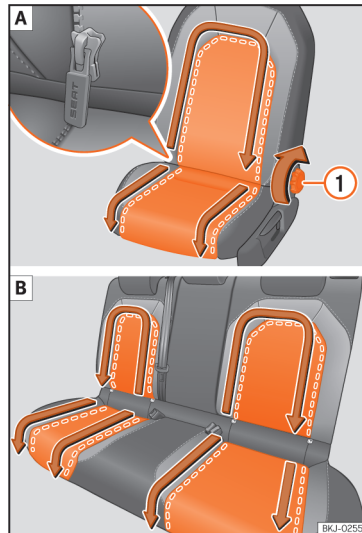


Fig. 114 Remove the covers. **A** Left front seat; **B** Rear seats



Fig. 115 Label on the covers: washing instructions symbols

Seasonal seats are seats with removable, reversible, exchangeable and washable covers.

Removing the cover

It is suggested to move the rear seats to their rearmost position so it is easier to remove and put the covers.

- Move the seat backwards until the handle of the zip is completely accessible »» Fig. 114 ①¹⁾.
- Move the handle of the zip in the direction indicated by the arrow »» Fig. 114. The removable cover is released.
- Pull the cover off.
- Move the seat back to driving position¹⁾.

Putting the cover

- Move the seat backwards until the anchor point of the zip is completely accessible¹⁾.
- Place the removable cover on the anchor of the zip (the pillows have 2 anchor points).
- Move the handle of the zip against the direction indicated by the arrow »» Fig. 114.
- Insert the excess fabric in the joint between pillow and backrest, ensuring that the removable cover is firm¹⁾.
- Move the seat back to driving position¹⁾.

⚠ CAUTION

- **Washing instructions for removable covers »» Fig. 115:**
 - Wash the covers in a washing machine using a delicate program, with water at 30°C and separately.
 - Do not use bleach, centrifuge or dry-clean.
 - Hang out the covers horizontally.
 - Iron the covers with steam, placing a piece of fabric between cover and iron.
 - Avoid contact between the iron and the Alcantara leather parts.

ⓘ Note

- If using the seats without removable covers, the handle of the zip must be at the start of the zip.
- To clean the upholstery of the seats, see the fabric cleaning section »» page 292.

¹⁾ Only in front seats.

Transport and practical equipment

Storing objects

Positioning the luggage and cargo

It is possible to carry objects and luggage in the vehicle, in a trailer » page 241 and on the roof » page 134. When doing so, please consider all legal provisions.

Placing luggage inside the vehicle safely

- Distribute the load in the vehicle as evenly as possible.
- Always place equipment and heavy objects in the boot » » ⚠.
- Position heavy items in the boot as far forward as possible.
- Take into account the maximum authorised weight per axle, as well as the maximum authorised weight of the vehicle » page 302.
- Secure the objects to the fastening rings of the boot using appropriate chains or belts » page 134.
- Also place small objects safely.
- Adapt tyre pressure to the load. Take into account the pressure adhesive of the tyres » page 278.

- In vehicles equipped with tyre control system, adjust to the new load status if necessary » page 282.

⚠ WARNING

Loose or unsecured objects can cause serious injury in case of sudden manoeuvring or braking or in case of an accident. Particularly if the airbag hits them when deploying and they are thrown across the inside of the vehicle. Please observe the following rules to minimise the risk of injury:

- Place all objects inside the vehicle safely.
- Secure all objects, little and large.
- Place the objects in the cabin in such a way that they can never reach the airbag deployment areas while the vehicle is in motion.
- Keep the storage compartments closed at all times while the vehicle is in motion.
- Place the objects in such a way that they never force any occupant of the vehicle to sit in an incorrect position.
- When transporting objects that take up a seat, never let anyone use that seat.
- Never leave hard, sharp or heavy objects loose in open storage compartment of the vehicle, on the cover behind the rear seat or on the dashboard.
- Remove all hard, sharp or heavy objects from the fabrics and bags inside the cabin and store them safely.

⚠ WARNING

The transport of heavy object changes vehicle handling and increases braking distance. Heavy objects that are not properly placed or secured may cause loss of control of the vehicle and thus severe injuries.

- Never put too much load in the vehicle. Both the carrying capacity as well as the distribution of the load in the vehicle have effects on the driving behaviour and braking ability.
- When transporting heavy objects, the driving behaviour of the vehicle varies due to the displacement of the centre of gravity.
- Always distribute the load in the vehicle as evenly and horizontally as possible.
- Always place heavy objects in the boot before the rear axle and as far away from it as possible.
- Objects in the luggage compartment that are unsecured could move suddenly and modify the handling of the vehicle.
- Adapt your speed and driving style at all times to suit visibility, weather, road and traffic conditions.
- Accelerate with particular care and caution.
- Avoid sudden braking and manoeuvres.
- Brake earlier than usual.



⚠ WARNING

- Never leave your vehicle unattended, especially when the rear lid is open. Children could climb into the luggage compartment, closing the door behind them; they will be trapped and run the risk of death.
- Close and lock all the doors and the rear lid when you leave the vehicle. Before you lock the vehicle, make sure that there are no adults or children in the vehicle.

ⓘ CAUTION

Electrical wires or, depending on the features, the antenna embedded into the rear windows could be damaged, even irreparably, if they are in contact with objects.

ⓘ Note

Straps for securing the load to the fastening rings are commercially available from accessory shops.

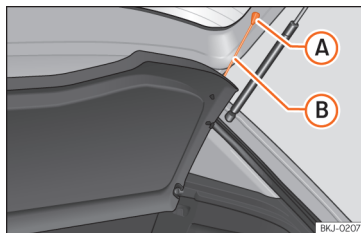
Luggage compartment**Luggage compartment shelf**

Fig. 116 In the luggage compartment: removing and fitting the shelf.

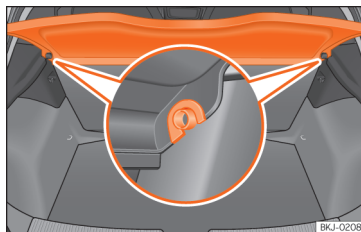


Fig. 117 In the luggage compartment: removing and fitting the shelf.

Removing

- Detach the cord loops »» Fig. 116 (B) from their hooks (A).

- Remove the rear shelf from the side supports »» Fig. 117 by pulling it upwards and then take it out.

If necessary, the rear shelf can be stored under the luggage compartment double floor »» page 133.

Fitting

- Insert the cover horizontally so that the "recess" fits onto the axis of the supports »» Fig. 117 and press down until it engages.
- Hook the loops »» Fig. 116 (B) to the rear lid.

⚠ WARNING

Animals, loose or unsecured or objects carried on the rear shelf can cause serious injury in case of sudden manoeuvring or braking or in case of an accident.

- Do not leave hard, sharp or heavy objects or in bags on the rear shelf.
- Never transport animals on the rear shelf.

ⓘ CAUTION

- Before closing the rear lid, ensure that the rear shelf is correctly fitted.
- An overloaded luggage compartment could mean that the rear shelf is not correctly seated and it may be bent or damaged.
- If the luggage compartment is overloaded, remove the tray.

Note

Ensure that, when placing items of clothing on the luggage compartment cover, rear visibility is not reduced.

Variable luggage compartment floor

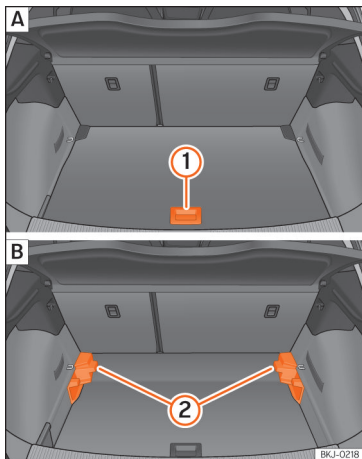


Fig. 118 Variable luggage compartment floor: **A** raised position; **B** lowered position.

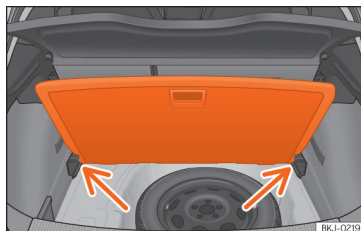


Fig. 119 Variable luggage compartment floor: inclined position.

Variable floor in high position

- To move from the low position to the high position, lift the floor using the handle »» Fig. 118 ①, and pull it back until the front of the floor has fully passed the supports ②.
- Move the floor forward over the supports as far as the rear seat backrest and then lower the floor with the handle ①.

Variable floor in low position

- To move from the high position to the low position, lift the floor using the handle »» Fig. 118 ①, and pull it back until the front of the floor has fully passed the supports ②.
- Now let the front part fall to the floor and slide the floor forwards as far as the rear seat backrest; lower the floor at the same time with the handle ①.

Variable floor in the tilted position

When the variable floor is tilted you can access the spare wheel or anti-puncture kit area.

- Lift the variable floor in the high position using handle »» Fig. 118 ①, pull it up and push it towards the backrest of the rear seats until it folds along the hinge line and the movable part of the floor is resting on itself.
- Rest the floor on its housings »» Fig. 119 (arrows).

⚠ WARNING

- Always secure objects, even when the luggage compartment floor is properly lifted.
- Only objects that do not protrude more than 2/3 the height of the floor may be carried between the rear seat and the raised luggage compartment floor.
- Only objects that do not weigh than approximately 7.5 kg may be carried between the rear seat and the raised luggage compartment floor.

ⓘ CAUTION

- The maximum weight that can be loaded on the luggage compartment variable floor in the top position is 100 kg.
- Do not let the luggage compartment floor fall when closing it. Always carefully »»

guide it downwards in a controlled manner. Otherwise, the lining and the floor of the luggage compartment could be damaged.

Fastening rings*

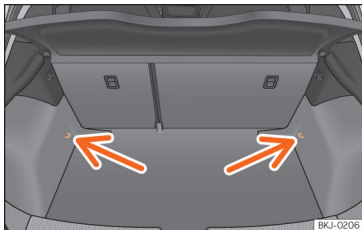


Fig. 120 Location of fastening rings in luggage compartment.

There are fastening rings » **Fig. 120** on the front and rear of the boot to secure loose objects and luggage with fastening belts and cords.

⚠ WARNING

If unsuitable or damaged belts or retaining straps are used, they could break in the event of braking or an accident. Objects could then be launched across the passenger compartment and cause serious or fatal injuries.

- Always use belts or straps that are suitable and in good condition.
- Tighten the belts and straps in a cross layout over the load placed on the boot floor and secure them to the fastening rings safely.
- Never exceed the maximum tensile load of the fastening rings when securing objects.
- Make sure that, particularly for flat objects, the upper edge of the load is higher than the fastening rings.
- Depending on the features, take into account the instruction panels on the boot on how to place the load.
- Never secure a child seat to the fastening rings.

i Note

- The maximum tensile load that the fastening rings can support is approx. 3.5 kN.
- Belts, straps and securing systems for the appropriate load can be obtained from specialised dealerships. SEAT recommends visiting a SEAT dealership for this.

Roof carrier*

Introduction

The vehicle roof has been designed to optimise aerodynamics. For this reason, cross bars or conventional roof carrier systems cannot be secured to the roof water drains.

As the roof water drains are integrated in the roof to reduce air resistance, only SEAT-approved cross bars and roof carrier systems can be used.

Cases in which cross bars and the roof carrier system should be disassembled.

- When they are not used.
- When the vehicle is washed in a car wash.
- When the vehicle height exceeds the maximum height, for example, in some garages.

⚠ WARNING

- Always secure the load properly using belts or retaining straps that are suitable and in a good condition.
- Bulky, heavy, long or flat loads have a negative effect on aerodynamics, the centre of gravity and driving performance.
- Avoid sudden braking and manoeuvres.
- Adapt your speed and driving style at all times to suit visibility, weather, road and traffic conditions.

ⓘ CAUTION

- Remove the cross bars and the roof carrier system before entering a car wash.
- Vehicle height is increased by the installation of cross bars or a roof carrier system and the load secured on them. For this purpose, check that your vehicle's height does not surpass the headspace limit, for example, for underpasses or for entering garage doors.
- Cross bars, the roof carrier system and the load secured on them should not interfere with the roof aerial or hamper the path of the panoramic sun roof and the rear lid.
- On opening the rear lid make sure that it does not knock into the roof load.

🌿 For the sake of the environment

When cross bars and a roof carrier system are installed, the increased air resistance means that the vehicle uses more fuel.

Securing the crossbars and the roof carrier system

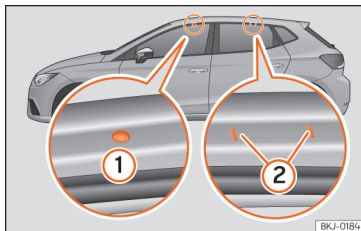


Fig. 121 Attachment points for the roof railings for the roof carrier system.

The crossbars are the basis of a series of special roof carrier systems. For safety reasons, special fixtures must be used to safely transport luggage, bicycles, skis, surf boards or boats on the roof. Suitable accessories can be acquired at SEAT dealerships.

Always secure the crossbars and the roof carrier system properly. Always take the assembly instructions that come with the crossbars and the roof carrier system in question into account.

The front and rear attachment points ① and ② are only visible when the doors are open »» Fig. 121.

⚠️ WARNING

Incorrect attachment and use of the crossbars and the roof carrier system may cause the whole system to detach from the roof and cause an accident and injuries.

- Always take the manufacturer assembly instructions into account.
- Check threaded joints and attachments travelling and if necessary tighten them after you have travelled a short distance. When making long trips, check the threaded joints whenever you stop for a rest.
- Do not modify or repair the crossbars or roof carrier system.

📘 Note


Always read the assembly instructions that come with the crossbars and the roof carrier system carefully and keep them in the vehicle.

Loading the roof carrier system

The load can only be secured if the crossbars and the roof carrier system are properly installed »» ⚠️.

Maximum authorised cargo on the roof


The maximum authorised cargo permitted for transporting on the roof is **75 kg**. This figure comes from the combined weight of the roof »»

carrier, the cross bars and the load itself on the roof »» .

Always check the weight of the roof carrier system, the cross bars and the weight of the load to be transported and weigh them if necessary. Never exceed the maximum authorised roof load.

If you are using cross bars and a roof carrier with a lower weight rating, you will not be able to carry the maximum authorised roof load. In this case, do not exceed the maximum weight limit for the roof carrier which is listed in the fitting instructions.

Distributing a load

Distribute loads uniformly and secure them correctly »» .

Check attachments

Once the cross bars and roof carrier system have been installed, check the bolted connections and attachments after a short journey and subsequently with a certain frequency.

WARNING

- Never exceed the maximum authorised load on the roof and on the axles or the vehicle's maximum authorised weight.
- Never exceed the load capacity of the cross bars and the roof carrier system,

even if the maximum authorised roof load has not been reached.

- Secure heavy items as far forward as possible and distribute the vehicle load uniformly.

WARNING

If the load is loose or not secured, it could fall from the roof carrier system or cause accidents and injuries.

- Always use belts or retaining straps that are suitable and in a good condition.

Storage compartment

Introduction

Use the storage compartments only for small or light items.

WARNING

Objects inside the vehicle that are not secured could be thrown across the cabin in the event of sudden braking or manoeuvring. This may cause severe injuries as well as loss of control of the vehicle.

- Do not carry animals or sharp, hard or heavy items in open storage compartments of the vehicle, on the dashboard or on the cover behind the rear seats, or inside

pieces of clothing or bags inside the vehicle.

- Keep the storage compartments closed at all times while the vehicle is in motion.

WARNING

Objects in the driver's footwell could difficult the use of the pedals. This may cause loss of control of the vehicle and increases the risk of severe injuries.

- Make sure that nothing prevents you from using the pedals at any time.
- Always secure the mat in the footwell.
- Never place other mats or other type of covers on the factory-fitted mat.
- Ensure that no objects can fall into the driver's footwell while the vehicle is in motion.
- When the vehicle is stationary, remove the objects in the footwell.

WARNING

If you leave lighters inside the vehicle, they might be damaged or lit inadvertently. This could lead to severe burns and damage to the vehicle.

- Before moving a seat, make sure there are no lighters in the moving part area of the vehicle.

- Before closing a storage compartment, make sure there are no lighters in the closing area.
- Never leave a lighter inside a storage compartment or any other surface of the vehicle as it could ignite due to the high temperatures on such surfaces, particularly during the summer.

ⓘ CAUTION

- Do not store heat- or cold-sensitive objects, food or medicines in the cabin. Heat and cold could damage them or render them useless.
- Objects made from transparent materials left inside the vehicle, such as glasses, magnifying glasses or transparent suction pads stuck to the windows can concentrate sunlight and damage the vehicle.

Glove compartment

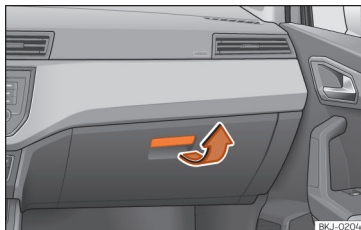


Fig. 122 On the front passenger side: glove compartment.

This compartment can hold documents in A4 format, a water bottle of 1.5 L, etc.

Depending on the vehicle's equipment, the CD player and SD card reader are located in the glove compartment.

Opening and closing the glove compartment

Opening: Pull the handle »» Fig. 122 and open the glove compartment.

Closing: Press the glove compartment upwards.

⚠ WARNING

If the glove compartment is left open, the risk of causing severe injuries in the event

of an accident, sudden braking or manoeuvring increases.

- Always keep the glove compartment closed while the vehicle is in motion.

Object holder under front seats*

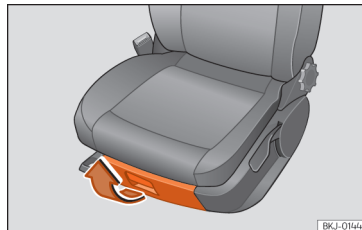


Fig. 123 Storage compartment under the right front passenger seat.

Opening: Press the tab on the drawer handle and take the drawer out.

Closing: Push the drawer under the seat until it engages.

⚠ WARNING

If the drawer is left open, it could prevent use of the pedals. This may cause serious accidents and injuries.

- Always keep the drawer closed while the vehicle is in motion. Otherwise, the drawer

»

and any objects in it could fall into the driver's footwell and obstruct the pedals.

ⓘ CAUTION

The drawer can contain 1.5 kg at most.

Storage bag in the seat*

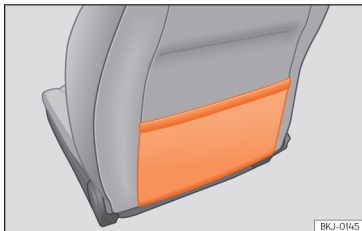


Fig. 124 Storage pocket.

There is a storage pocket on the rear of the front seats.

ⓘ CAUTION

Do not place overly large objects in the pockets (e.g. bottles) or objects with sharp edges. Risk of damage to the pockets and the upholstery.

Other object holders

You will find more object holders, compartments and supports in other parts of the vehicle:

- In the centre console.
- Inside the central armrest*.
- Other storage compartments are found in the rear seat, to the left and the right of the seats.

Drink holder

Introduction

Bottle holder

The storage compartments of the driver and passenger doors contain a bottle holder.

⚠ WARNING

Incorrect use of the bottle holders may cause injuries.

- Never put hot drinks in the drink holders. In the event of sudden braking or an accident while driving, hot beverages in the bottle holders might spill and cause burns.
- Ensure that no bottles or other objects are dropped in the driver footwell while driving, as they could get under the pedals and obstruct their working.

- Never place glasses, food or other heavy objects drink holders. These heavy objects may be thrown across the cabin in the event of an accident and cause serious injuries.

⚠ WARNING

Closed bottles may explode inside the vehicle due to cold or heat.

- Never leave closed bottles in the vehicle if the temperature inside is very high or very low.

ⓘ CAUTION

Do not leave open cans in the drink holders when the vehicle is in motion. If the drink is spilled (e.g. due to sudden braking) it may damage the vehicle and its electrical system.

ⓘ Note

The inside elements of the drink holders can be extracted for cleaning.

Front drink holders*

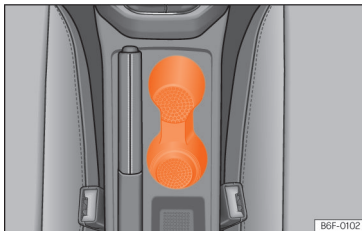


Fig. 125 Front drink holders in the centre console.

In the central console, next to the hand brake, there are two drinks holders »»» **Fig. 125**.

Power sockets

Vehicle power sockets

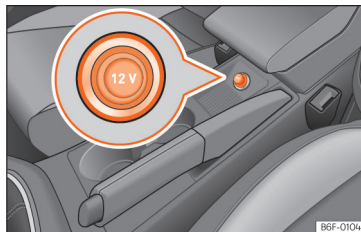


Fig. 126 Front power socket.

- Remove the plug from the socket located in the centre console »»» **Fig. 126**.
- Insert the plug of the electrical appliance into the power socket.

Electrical equipment can be connected to the 12 volt power socket.

The appliances connected to each power socket must not exceed a power rating of 120 Watt.

⚠ WARNING

The power socket works only when the ignition is on. Improper use may cause serious injury or even fire. Children should therefore not be left in the vehicle unattended if the button is also left behind. Otherwise

there is a possibility that they may be injured.

ⓘ CAUTION

Always use the correct type of plugs to avoid damaging the sockets.

ⓘ Note

- The use of electrical appliances with the engine switched off will cause a battery discharge.
- Should the connected appliance overheat, immediately switch it off and disconnect it from the socket.
- Before switching the ignition on or off, unplug the appliances from the USB ports to protect them from any damage caused by fluctuations in voltage.

Air conditioning

Heating, ventilation and cooling

Introduction

Depending on the vehicle's equipment, several systems may have been fitted:

- The **heating and ventilation** heats and ventilates the passenger compartment. It cannot cool.
- The **manual air conditioning** and the **Climatronic** cool and dehumidify the air. They operate most effectively with the windows and the sunroof closed.

To switch a specific function on, press the appropriate button. Press the button again to switch off the function.

The LED on each control lights up to indicate that the respective function of a control has been switched on.

Dust and pollen filter

The dust and pollen filter with its activated charcoal cartridge serves as a barrier against impurities in the air taken into the vehicle interior.

The dust and pollen filter must be changed regularly so that air conditioner performance is not adversely affected.

If the filter loses efficiency prematurely due to use in areas with very high levels of air pollution, the filter must be changed more frequently than stated in the Service Schedule.

WARNING

Reduced visibility through the windows increases the risk of serious accidents.

- Always ensure that all windows are free of ice and snow, and that they are not fogged, so as to maintain good visibility of everything outside.
- Only drive when you have good visibility.
- Always ensure that you use the air conditioning, heater or rear window heating to maintain good visibility to the outside.
- Never leave the air recirculation on for a long period of time. If the cooling system is switched off and air recirculation mode switched on, the windows can mist over very quickly, considerably limiting visibility.
- Switch air recirculation mode off when it is not required.

WARNING


Stuffy or used air will increase fatigue and reduce driver concentration possibly resulting in a serious accident.

- Never leave the fresh air fan turned off or use the air recirculation for long periods of time; the air in the vehicle interior will not be refreshed.

CAUTION

- To replace the pollen filter, always visit a service centre.
- Switch the climate control or air conditioner off if you think it may be broken. This will avoid additional damage. Have the climate control or air conditioning checked by a specialised workshop.
- Repairs to the climate control or air conditioning require specialist knowledge and special tools. SEAT recommends visiting a SEAT Official Service.

Note

- When the cooling system is turned off, air coming from the outside will not be dried. To prevent fogging of the windows, SEAT recommends leaving the cooling system (compressor) turned on. To do this, press the  button. The button lamp should light up.
- The maximum heat output required to defrost windows as quickly as possible is only available when the engine has reached its normal running temperature.
- Keep the air intake slots in front of the windscreen free of snow, ice and leaves to

ensure heating and cooling are not impaired, and to prevent the windows from misting over.

- The air from the vents flows through the vehicle interior and is extracted by slots in the luggage compartment designed for this purpose. Therefore, you should avoid obstructing these slots with any kind of object.

- Do not smoke while air recirculation mode is on, as smoke drawn into the air conditioning system leaves residue on the evaporator, producing a permanent unpleasant odour.

- It is advisable to turn on the air conditioning at least once a month, to lubricate the system gaskets and prevent leaks. If a decrease in the cooling capacity is detected,

a Technical Service should be consulted to check the system.

- When the engine is under extreme strain, switch off the compressor for a moment.

Climatronic* controls



Fig. 127 In the centre console: Climatronic controls.

Automatic mode **AUTO**

Automatic adjustment of temperature, fan, and air distribution. Automatic mode is disabled when the ventilation is modified manually.

Cooling mode **A/C**

Press the button to switch on or off the cooling system.

Temperature **1/2**

The temperature of the right and left sides can be adjusted separately using the adjusters. The selected temperature is shown on the display of the climate control panel.

Synchronisation: press button **SYNC** so that settings on the driver's side apply to the passenger side. Use the temperature regulator

for the passenger side to set a different temperature.




Blower

The power of the fan is automatically adjusted.

Press the buttons to manually adjust the fan. »

Air distribution / /

The airflow adjusts automatically for comfort. It can also be manually distributed to the desired zone by pressing the corresponding button:

-  The airflow is directed towards the chest
-  The airflow is directed towards the footwell.
-  The airflow is directed at the windscreen.

Defrost/demist function **MAX**

The air drawn in from outside the vehicle is directed at the windscreen and air recirculation

is automatically switched off. To defrost the windscreen more quickly, the air is dehumidified at temperatures over approximately +3°C [+38°F] and the fan runs at maximum output.

Heated rear window

This only works when the engine is running and switches off automatically after a maximum of 10 minutes.

It should be switched off as soon as the glass is demisted. By saving electrical power you can also save fuel.

To avoid possible damage to the battery, an automatic temporary disconnection of this function is possible, coming back on when normal operating conditions are re-established.

Air recirculation

» page 144

Seat heating

» page 145

Switching off

Press button **OFF** or manually set the fan to **0**.

Manual air conditioning* controls / Heating and fresh air system

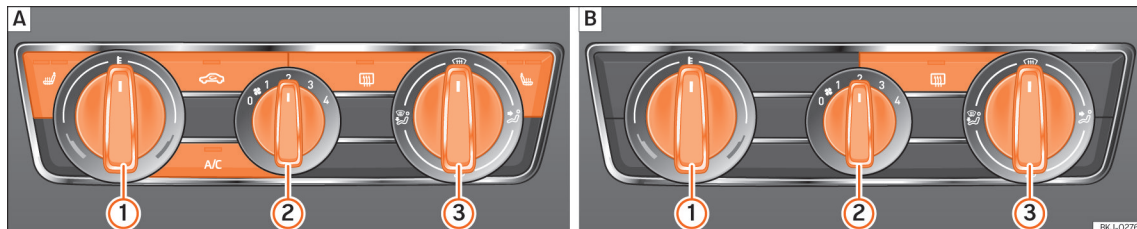


Fig. 128 In the centre console: **A** controls for the manual air conditioning; **B** heating and fresh air system controls.

Cooling mode A/C

Manual air conditioning: Press the button to switch on or off the cooling system.

Temperature ①

Turn the control to adjust the temperature.

Heating and fresh air system: The temperature cannot be lower than that of the exterior air temperature, as this system cannot cool or dehumidify the air.




Blower ②

Turning the regulator ② sets the fan power.


At level 0 the fan and manual air conditioning are disconnected. Level 4 is the maximum.

Air distribution ③

Turning regulator ③ distributes the air to the desired zone:

-  The airflow is directed towards the chest
-  The airflow is directed towards the footwell.
-  The airflow is directed towards the windscreen and the footwell area.

Defrost/demist function ④

Manual air conditioning: When control ③ is in position  the air flow is directed at the windscreen and air recirculation is disconnected automatically or not activated. Increase the

fan power to clear the windscreen of condensation as soon as possible. To dehumidify the air, the cooling system will automatically switch on.

Heated rear window ⑤

This only works when the engine is running and switches off automatically after a maximum of 10 minutes.

It should be switched off as soon as the glass is demisted. By saving electrical power you can also save fuel.

To avoid possible damage to the battery, an automatic temporary disconnection of this function is possible, coming back on when normal operating conditions are re-established.

Air recirculation ⑥

»» page 144

Seat heating ⑦

»» page 145

Climate control usage instructions

The interior cooling system only works when the engine is running and fan is switched on.

Economic use of the air conditioning

When the air conditioning is switched on, the compressor consumes engine power and has influence on fuel consumption.

The air conditioner operates most effectively with the windows and the panoramic sliding sunroof closed. However, if the vehicle has heated up after standing in the sun for some time, the air inside can be cooled more quickly by opening the windows and the panoramic sliding sunroof briefly.

Change the temperature unit (Climatronic)

The temperature display can be changed from Celsius to Fahrenheit on the series Infotainment system display, using the Infotainment button **MENU / ⑧** > **Settings/System** > **Units**.

The cooling system cannot be activated

If the air conditioning system cannot be switched on, this may be caused by the following:

- The engine is not running.
- The fan is switched off.
- The air conditioner fuse has blown.
- The outside temperature is lower than approximately +3°C (+38°F).

»

- The air conditioner compressor has been temporarily switched off because the engine coolant temperature is too high.
- Another fault in the vehicle. Have the air conditioner checked by a specialised workshop.

Special characteristics

If the humidity and temperature outside the vehicle are high, **condensation** can drip off the evaporator in the cooling system and form a pool underneath the vehicle. This is normal and does not indicate a leak!

Note

After starting the engine, any residual humidity in the air conditioner could mist over the windscreen. Switch on the defrost function as soon as possible to clear the windscreen of condensation.

Air vents

To ensure proper heating, cooling and ventilation in the vehicle interior, the air vents must remain open.

- To close the air vents on the left side, move the corresponding diffuser vent lever fully to the right. To close the air vents on the right side, move the corresponding diffuser vent lever fully to the left.

- Change the air direction using the ventilation grille lever.

There are other additional, non-adjustable air vents in the dash panel, in the footwells and in the rear area of the passenger compartment.



Note

Food, medicine and other heat or cold sensitive objects should never be placed in front of the air outlets as they may be damaged or made unsuitable for use by the air.

Air recirculation

Air recirculation mode prevents the ambient air from entering the interior.


When the outside temperature is very high, selecting manual air recirculation mode for a short period refreshes the vehicle interior more quickly.

For safety reasons, air recirculation mode is switched off when the button **MAX**  is pressed or the air distributor is turned to .

Switching the manual air recirculation mode on and off

- Press the button  to connect or disconnect manual air recirculation.

WARNING

Observe the safety warnings »  in Introduction on page 140.

- If the cooling system is switched off and air recirculation mode switched on, the windows can mist over very quickly, considerably limiting visibility.
- Switch air recirculation mode off when it is not required.

CAUTION

Do not smoke when air recirculation is switched on in vehicles with an air conditioner. The smoke taken in could lie on the cooling system vapouriser and on the activated charcoal cartridge of the dust and pollen filter, leading to a permanently unpleasant smell.

Note

Climatronic: air recirculation mode is activated to prevent exhaust gas or unpleasant odours from entering the vehicle interior when it is in reverse and while the automatic windscreen wiper is working.

Note







If the temperature regulator is turned to the coldest setting (blue point), the air recirculation function and the A/C button are automatically activated.

- If the function is not deactivated by pressing the button, it will deactivate after approximately 20 minutes.

Seat heating*

The seat cushions can be heated electrically when the ignition is switched on. The backrest is also heated in some versions.

Control seat heating

- Press buttons  or  on the control panel to turn on the seat heating as high as possible.
- Press buttons  or  repeatedly to adjust it to the required level.
- To turn off the seat heating, press button  or  repeatedly until no LEDs are lit.

Cases in which the heat seating should not be switched on

Do not switch the seat heating on if any of the following conditions are met:

- The seat is not occupied.
- The seat has a cover.
- A child seat has been installed on the seat.
- The seat cushion is wet or damp.
- The outdoor or indoor temperature is greater than +25°C (77°F).

WARNING

People who cannot perceive pain or temperature because of medications, paralysis or chronic diseases (e.g. diabetes) or have a limited perception of these, may suffer burns to the back, buttocks or legs when using seat heating.

- People with limited pain and temperature thresholds must never use seat heating.
- If an abnormality in the device's temperature control is detected, have it checked by a specialist workshop.

WARNING

If the fabric of the cushion is wet, this can adversely affect the operation of the seat heating, increasing the risk of burns.

- Make sure the seat cushion is dry prior to using the seat heater.
- Do not sit on the seat with clothing that is wet or damp.
- Do not leave clothing that is wet or damp on the seat.
- Do not spill liquid on the seat.

CAUTION

- To avoid damaging the heating elements of the seat heaters, please do not kneel on the seat or apply sharp pressure to a single point on the seat cushion or backrest.

- Liquids, sharp objects and insulating materials (e.g. covers or child seats) can damage the seat heating.
- In the event of smells, switch off the seat heating immediately and have it inspected by a specialised workshop.

For the sake of the environment

The seat heating should remain on only when needed. Otherwise, it is an unnecessary fuel waste.

Infotainment system

Introduction

First steps

Introduction

Infotainment functions and settings depend on the country and equipment

Before first use

Before the first use, bear in mind the following points, to take full advantage of the functions and settings offered:

- Observe the basic safety warnings
»» page 146.
- Reset the Infotainment factory settings.
- Search and store favourite radio stations on the preset buttons so you can tune them quickly.
- Use only suitable audio sources and data media.
- Pair a mobile phone to use phone management through the Infotainment system.
- Use current maps for navigation.
- Register in SEAT CONNECT to run the corresponding services.

Current documentation attached

For using infotainment and its components, take into account, together with this instruction manual, the following documentation:

- Supplements to your vehicle's on-board documentation.
- Instruction Manual of the mobile phone device or audio sources.
- Operating instructions for data media and external players.
- Manuals for the Infotainment accessories subsequently installed or used additionally.
- Description of services when running SEAT CONNECT services.

Safety instructions

Some function areas may include links to third-party websites. SEAT, S.A. is not the owner of the third-party websites accessible through the links, and assumes no liability for their content.

Some function areas may include outside information from third-party providers. SEAT, S.A. is not responsible for such information being correct, up-to-date or complete, or for ensuring it does not infringe the rights of third parties.

Radio stations and owners of data media and audio sources are responsible for the information they transmit.

Bear in mind that parking lots, tunnels, tall buildings, mountains or due to the operation of other electrical devices, such as chargers, can also interfere with the reception of the radio signal.

Foils or adhesives with metallic layers on the antenna and on the window panes can interfere with radio reception.

WARNING

The infotainment central computer is interconnected with the control units mounted on the vehicle. Therefore, there is a serious danger of accident and injury if the central computer is repaired or disassembled and reassembled incorrectly.

- **Never replace the central computer with another used, recycled or from another vehicle at the end of its useful life.**
- **The repair or disassembly and reassembly of the central computer should only be carried out at specialised workshops. SEAT recommends visiting a SEAT dealership for this.**

WARNING

The factory assembled radio with integrated software is interconnected with the control units mounted on the vehicle.

Therefore, there is a serious danger of accident and injury if the radio is repaired or disassembled and reassembled incorrectly.

- Never replace the radio with another radio that is used, recycled or from another vehicle at the end of its useful life.
- The repair or disassembly and reassembly of the radio should only be carried out at specialised workshops. SEAT recommends visiting a SEAT dealership for this.

WARNING

Any distraction affecting the driver in any way can lead to an accident and cause injuries. Reading the information on the screen and managing the infotainment system can distract your attention from traffic and cause an accident.

- Always drive as carefully and responsibly as possible.

WARNING

Connecting, inserting or removing an audio source or data media while driving can distract your attention from the traffic and cause an accident.

WARNING

Select volume settings that allow you to easily hear signals from outside the vehicle

at all times (e.g. emergency services sirens).

- Hearing may be impaired if using too high a volume setting, even if only for short periods of time.

WARNING

The following circumstances may result in an emergency call, phone call or data transmission not being made or being interrupted:

- When in areas with zero or insufficient mobile telephony or GPS signal. Also in tunnels, confined areas between very tall buildings, garages, underpasses, mountains and valleys.
- When in areas with sufficient mobile phone or GPS signal, the telephony network of the telecommunications provider has interference or is not available.
- When the vehicle components necessary to make emergency calls, phone calls and to transmit data are damaged, do not work or do not have sufficient electrical power.
- When the battery of the mobile phone device is discharged or its charge level is insufficient.

WARNING

In some countries and some telephone networks it is only possible to make an emergency call, if a mobile telephone device is

connected to the telephone interface of the vehicle, inside it there is an “unlocked” SIM card with sufficient balance to make calls and with sufficient network signal coverage.

WARNING

Read and observe the operating instructions provided by the manufacturer in question when using mobile phone devices, data media, external devices, external audio and multimedia sources.

WARNING

Position the connection cables of the audio sources and external devices so that they do not interfere with the driver.

WARNING

When changing or connecting an audio or multimedia source may cause sudden changes in the volume.

- Lower the volume before connecting or switching to audio or multimedia sources.

WARNING

If mobile phone and radiocommunication devices are used without connection to an external antenna, the maximum electromagnetic radiation levels inside the vehicle might be surpassed, thus posing a risk to the health of the driver and passengers.

This is also the case if the external antenna has not been correctly installed.

- Keep a distance of at least 20 centimetres between the antennas of the mobile phone device and an active medical device, such as a pacemaker, as mobile phones might alter the functioning of these devices.
- Do not carry a mobile phone switched on very close or directly on top of an active medical device, for instance in a chest pocket.
- Immediately turn off the mobile phone if you suspect it is causing interferences in an active medical device or any other medical device.

WARNING

Mobile phones, external devices and accessories that are loose or not properly secured could move around the passenger compartment during a sudden driving or braking manoeuvre or an accident and cause damage or injury.

- Set mobile phone devices, external devices and their accessories outside the airbag deployment areas or store them securely.

WARNING

The centre armrest may obstruct the driver's arm movements, which could cause an accident and severe injuries.

- Keep the storage compartments of the centre armrest closed at all times while the vehicle is in motion.

WARNING

If the light conditions are not good and the screen is damaged or dirty, the indications and information displayed on the screen may not be read or be read incorrectly.

- The indications and information displayed on the screen should never induce to take any risk that compromises safety. The screen is not a replacement for driver awareness.

WARNING

Radio stations can transmit disaster or hazard announcements. The following conditions prevent such notices from being received or issued:

- When in areas with zero or insufficient radio signal. Also in tunnels, confined areas between very tall buildings, garages, underpasses, mountains and valleys.
- When the frequency bands of the radio station have interference or are not available in areas with sufficient radio signal reception.

- When the speakers and the vehicle components necessary for radio reception are damaged, do not work or do not have sufficient electrical power.
- When the infotainment is switched off.

WARNING

Switch off mobile phone devices in areas with a risk of explosion!

WARNING

The driving recommendations and traffic indications shown on the navigation system may differ from the current traffic situation.

- Traffic signs, signalling systems, traffic regulations and local circumstances prevail over driving recommendations and navigation system indications.
- Adapt your speed and driving style to suit visibility, weather, road and traffic conditions.
- Certain circumstances can significantly initially planned lengthen both the duration of the trip and the route to the destination, or even temporarily prevent navigation to it, for example, if a road is closed to traffic.

Note

In areas where special regulations apply or the use of mobile phones is forbidden, the mobile device in question must be switched off at all times. The radiation produced by

a mobile phone device when switched on may interfere with sensitive technical and medical equipment, possibly resulting in malfunction or damage to the equipment.

 **Note**

If the playback volume is excessive or distorted, the speakers may be damaged.

Overview and controls

Connect System

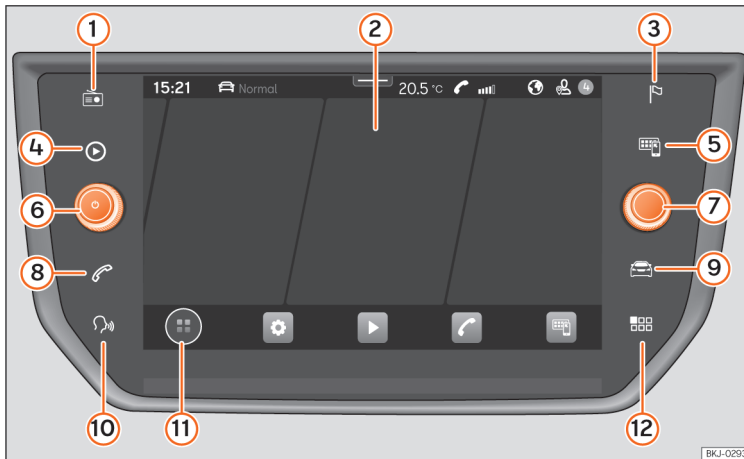


Fig. 129 Overview of the controls [this configuration depends on the version].

- | | |
|--|---------------------------------|
| ① Radio mode | ⑧ Phone Mode |
| ② Touch screen | ⑨ Vehicle settings |
| ③ Navigation Mode | ⑩ voice control |
| ④ Media Mode | ⑪ HOME button. |
| ⑤ Full Link | Ⓜ: main menu with widget views. |
| ⑥ Volume. Off/on | Ⓜ: main menu in mosaic mode. |
| ⑦ Settings button (search and selection) | ⑫ Main menu |

General instructions for use

Operating indications

- The infotainment needs a few seconds for the complete start-up of the system and during that time it does not react to inputs. Only the image of the rear view camera* system can be displayed during system start-up.
- The display of all indications and the execution of functions only takes place once the infotainment system has finished booting. The duration of the system booting depends on the number of infotainment functions and may take longer than normal in the event of very high or very low temperatures.
- When using the infotainment system and corresponding accessories, e.g., headphones, bear in mind country-specific regulations and legal provisions.
- Some functions of the infotainment system require an active SEAT CONNECT user account and an Internet connection for the vehicle. The data transmission must not be limited to perform the functions.
- To use the infotainment system, simply lightly press a button or touch the screen.
- For the correct operation of the infotainment system it is important that it is switched on and that, if necessary, the time and date of the vehicle are set correctly.
- If a function button is missing on the screen, it is not a device defect, but corresponds to the specific equipment of the country or version.
- Some infotainment functions can only be selected when the vehicle is at a standstill. In some countries, the selector lever must also be in the parking position **P** or in neutral position **N**. It is not a malfunction, but is due to compliance with legal provisions.
- Restrictions on the use of devices using Bluetooth® technology may apply in some countries. For further information, contact the local authorities.
- If you disconnect the 12-volt battery, turn on the ignition before restarting the infotainment system.
- If the setup is changed, this may change the display on the screen and in some cases, the infotainment system may behave in a manner different to that described in this instruction manual.
- Ensure that any repairs or modifications that need to be carried out on the infotainment system are carried out by a specialised workshop. SEAT recommends visiting a SEAT dealership for this.
- Using a mobile phone device inside the vehicle may cause noise in the speakers.
- In some countries, the infotainment system automatically shuts off when the engine is

switched off and the vehicle's 12-volt battery charge level is low.

- On vehicles with park assist, the audio source volume is automatically lowered when reverse gear is selected. The volume reduction can be adjusted.
- Information about the included software and the license conditions can be found in **Settings > Copyright**.
- When selling or lending the vehicle, make sure that all saved data, files and settings have been deleted and, if necessary, external audio sources and data media have been removed.

Note

You will find more information and tips for using the infotainment system in the Help menu.


HOME screen

In the control and display unit you can set up the views and representation on the home screen or use the factory setting templates.

If an icon is missing on the screen, it is not a device defect, but corresponds to the specific equipment of the country or version.

The following menus can be included as an icon on the home screen: »

Main menus on the home screen

	Navigation »»» page 178
	Radio/Multimedia »»» page 171
	Telephone »»» page 185
	Full Link »»» page 162
	Setup »»» page 153
	Vehicle »»» page 90
	Data »»» page 89
	Air conditioning »»» page 140
	Sound
	Users
	Privacy mode »»» page 161
	Store
	Legal
	Help

^{a1} Depends on the selected privacy mode.

Managing the infotainment system

Execute the functions and settings with the infotainment controls.

Depending on the equipment, the infotainment system has different controls:

- Touch screen.
- Touch zones outside the screen, for example, Volume [+ -].
- Function buttons, for example, **RADIO** or **MEDIA**.

Opening the Quick Guide

You will find more information and tips for handling in the Quick Guide of the infotainment system.

- Press **HOME** > .

Connecting and disconnecting the infotainment system

The infotainment system turns on when the ignition is switched on, unless it has been manually turned off beforehand.

The infotainment system starts-up with the last set volume, provided that this does not exceed the preset maximum start-up volume.

The infotainment system automatically turns off when the driver's door is opened, provided the ignition has been switched off beforehand.

Moving objects and adjusting volume

Move objects on the screen to adapt settings, for example, with scrollable buttons or to move the areas of a menu.

Depending on the equipment, customise menus and views.

Increasing and reducing images or map sizes

Tip: use your thumb and index finger.

- Press on the map with both fingers at the same time and leave them on the screen.
- To enlarge views, slowly separate one finger from the other. To reduce views, slowly bring one finger towards the other.

Note

If you turn on the infotainment system manually with the ignition off, it will automatically turn off after about 30 minutes.

Customising the infotainment system

Customise the menus and infotainment views to quickly access your favourite or most frequently used functions.

The main menu contains function buttons for accessing all of the Infotainment apps.

Customise shortcuts

At the bottom of the screen you will find shortcuts to customisable system functions. Use the settings to delete or replace them, or change their order.

- Press and hold one of the icons (or press + of an empty position) to display an additional window.
- Select one of the icons from the apps bar.
- Press X to delete an icon.
- Click on an icon in the additional window to replace the value.
- Hold your finger on one of the icons and drag it to the desired position.
- To close the edit more, press X in the additional window, or press ⊕.

Note

The shortcut bar cannot be edited when the vehicle is moving.

Settings (system and sound)

The selection of possible settings varies depending on the country, the equipment in question and the equipment of the vehicle.

Modifying settings

The meaning of the following symbols are valid for all system and sound settings.

All changes are automatically applied when the menus are closed.

Symbol and its meaning	
<input checked="" type="checkbox"/> / <input checked="" type="radio"/>	The setting is selected and activated or connected.
<input type="checkbox"/> / <input type="radio"/>	The setting is not selected, disabled or disconnected.
▼	To open a drop-down list.
+	To increase a setting value.
-	To decrease a setting value.
<	To go back step by step.
>	To go forward step by step.
☰	To change a setting value with the scrollable button without adjusting.

Sound settings

Access the sound settings: HOME > 🎧

In the sound settings there may be the following functions, information and setting options:

- Equaliser
- Position.
- Settings.

System settings

Access the system settings: HOME > ⚙️.

In the system settings there may be the following functions, information and setting options:

- Screen.
- Time and date.
- Language.
- Additional keypad languages.
- Units.
- Voice control.
- Wi-Fi.
- Applications and services
- Manage mobile devices.
- Reset factory settings.
- System information.
- Copyright.
- Configuration wizard.

Adjust the volume of external audio sources

If you need to increase the playback volume for the external audio source, first lower the volume on the infotainment system.

If the sound from the connected audio source is **very low**, increase the **output volume** on the external audio source. If this is not »

enough, change the **input volume** to **medium** or **high**.

If the sound from the connected external audio source is **too loud or distorted**, lower the **output volume** on the external audio source. If this is not enough, change the **input volume** to **medium** or **low**.

Clean the screen

Remove persistent dirt carefully and without using aggressive cleaning products. To clean the screen we recommend that:

- The infotainment system is switched off.
- Use a clean, soft cloth dampened with water »» page 289.
- In case of persistent dirt: soften the dirt by moistening with a little water. Then carefully remove with a clean, soft cloth.

ⓘ CAUTION

Cleaning the screen with inappropriate cleaning products or when dry, may damage it.

- **When cleaning, only press lightly.**
- **Do not use aggressive cleaning products or that contain solvents. Such products**

may damage the equipment and "darken" the screen.

Trademarks, licenses and copyrights

Registered trademarks and licenses

Certain terms in this manual bear the symbol ® or ™. These symbols indicate that it is a trademark or a registered trademark. The absence of this symbol, however, does not necessarily mean that the term in question can be used freely.

Other product names are registered trademarks or trademarks of the respective rights holders.

- Manufactured under license from Dolby Laboratories. Dolby and the double-D symbol are trademarks of Dolby Laboratories.
- Manufactured under license from Dolby Laboratories. Dolby and the double-D symbol are trademarks of Dolby Laboratories.
- Android Auto™ is a trademark of Google Inc.
- Apple CarPlay™ is a trademark of Apple Inc.

- Bluetooth® is a registered trademark of Bluetooth® SIG, Inc. iPod®, iPad® and iPhone® are trademarks of Apple Inc.
- MirrorLink™ and MirrorLink Logo are certified trademarks of Car Connectivity Consortium LLC.
- Windows® is a registered trademark of Microsoft Corporation, Redmond, USA.
- MPEG-4 HE-AAC audio coding technology and patents are licensed by Fraunhofer IIS.
- This product is protected by certain Microsoft Corporation industrial and intellectual property rights. The use or commercialization of technology of this type outside the configuration of this product, without a licence from Microsoft or an authorised Microsoft branch is prohibited.

Copyright

As a general rule, audio and video files stored on data media and audio sources are subject to intellectual property protection in accordance with the national and international provisions applicable in each case. Please bear in mind all legal provisions!

Technical data

Radio with integrated hardware [8.25"]¹⁾

The factory-mounted radio in the vehicle with integrated hardware includes country-specific components and software for connectivity and for the execution of vehicle, comfort and infotainment functions.

The corresponding indications are shown on the radio screen and partly on the instrument panel.

- Capacitive colour screen:
 - 8.25 inch version, TFT, WVGA: 1082 x 480 pixels.
- Touch operation via the device screen, rotary push-button, menu button and buttons on the multifunction steering wheel.

Central computer with control and display unit [10"]²⁾

The factory-mounted central computer in the vehicle includes country-specific components and software for connectivity and for the execution of vehicle, comfort and infotainment functions.

The corresponding indications are shown on the control and display unit screen and partly on the instrument panel.

- Capacitive colour screen:
- Using the equipment with:
 - Touch zones Touch operation.
 - Buttons on the multifunction steering wheel.
 - Approach sensors (driver and passenger side recognition, gesture control).

Vehicle and comfort functions

- Driver assistance system settings.
- Heating and air conditioning settings.
- Lights and visibility function settings.
- Vehicle comfort settings.
- Parking and manoeuvring settings.

Sound system

Basic equipment:

The infotainment system that is supplied from the factory is equipped as follows:

- Speakers in different locations and with different power levels (watts).
- Internal amplifier depending on the system:

- 4 speakers: 2 x 20 W
- 6 speakers: 5 x 20 W
- Setting options:
 - Equaliser, depending on the system:
 - 4 speakers: treble, mid and bass.
 - 6 speakers: 5 frequency bands or pre-defined settings.
 - Sound distribution, depending on the system:
 - 4 speakers: Balance (left / right)
 - 6 speakers: Balance + Fader (left / right / front / rear).
 - Sound optimisation by zones (valid for the 6-speaker system):
 - Manual (Driver and All)
 - Automatic depending on the seats occupied.

Optional sound system

The infotainment system can be extended with an optional sound system as follows:

- 7 speakers in different locations and with different power levels (watts).
- 300W external amplifier (Ethernet or CAN, depending on the infotainment system), which processes the audio signals sent by the central computer. »

¹⁾ Equipment name: Media System

²⁾ Equipment name: Connect System.

- Excitation of speaker channels through class AB final stages.
- Audio signal processing in digital internal signal processor [DSP].
- Independent subwoofer in the luggage compartment.
- Setting options:
 - User equaliser: 5 bands.
 - Sound distribution: Balance + Fader (left / right / front / rear).
 - Sound optimisation by zones:
 - Manual (Driver, Front and All)
 - Subwoofer volume.
- Internet connection via Wi-Fi:
 - Tethering through the customer's phone.
 - Customer access point (clients) in the vehicle.
- *Media System*:
 - Internet connection via Wi-Fi:
 - Apple CarPlay wireless.
- Apple CarPlay and Android Auto over Wi-Fi.
- Pairing process simplified by WPS or QR code.

- **Message profile (MAP):** It allows short messages (SMS) to be downloaded and synchronised.

Connectivity

Wi-Fi

- Wi-Fi conforming to IEEE 802.11 b/g/n.
- Transfer in 2.4 GHz and 5 GHz.
- Three Wi-Fi modes at the same time:
 - Tethering (2.4 GHz).
 - 2.4 GHz access point.
- *Connect System*:
 - Simultaneous connection of up to 8 Wi-Fi devices.
- *Media System*:
 - Simultaneous connection of up to 2 Wi-Fi devices.
- *Connect System*:
 - **Hands-free telephone profile (HFP):** the HFP can be used to manage calls through the infotainment system.
 - **Audio profile (A2DP):** This profile allows audio to be transmitted with stereo quality. It may require connecting other profiles for managing and controlling playback.
 - **Phone book access profile (PBAP):** Allows phone book contents to be downloaded from the mobile telephone.

Data transfer

SEAT CONNECT

Introduction



To use it, SEAT CONNECT must first be activated online by entering into a SEAT CONNECT contract with SEAT, S.A. and is subject to a temporary use limitation depending on the country.

Both the SEAT CONNECT service portfolios offered by SEAT and individual services can be modified, cancelled, deactivated, reactivated, renamed and extended, even without prior notification.

In <https://my.seat> you can create the user account, see the description of services and more information.

The execution and availability of the SEAT CONNECT services and service portfolios may vary depending on the country, as well as the vehicle, its equipment and connectivity.

Connectivity statuses

 (white)	Full connectivity, all services active
 (grey)	Limited connectivity, some services may not be available.
no icon	No connectivity, no services available.

SEAT CONNECT's voice recognition or search technology does not recognise or offer results for all words.

There are SEAT CONNECT services for which registration is mandatory and others for which it is not mandatory.

Description of services

Before running SEAT CONNECT services, read and take into account the description of the corresponding services. Descriptions are updated non-periodically and are available online at <https://my.seat>.

- Always use the most up-to-date version of the corresponding service description.

WARNING

In areas with insufficient mobile phone and GPS signal coverage, neither emergency calls nor phone calls can be made, and data cannot be transmitted. Where possible, change location.

CAUTION

The vehicle may be damaged by factors outside the control of SEAT, S.A. These may be specifically:

- Misuse of mobile terminals
- Data loss during transmission
- Unsuitable or defective third party applications
- Malicious software on data storage devices, computers, tablets or mobile phones

Services portfolio

The initial service allocation shown here corresponds to the third generation of SEAT CONNECT services and represents the maximum services portfolio. The maximum possible portfolio is only available on some vehicle models. During the useful life of the vehicle, you can change the assignment shown here.

After activating the services management in the infotainment system you can check if the vehicle has services and what they are.

In some countries and in the event of a contract renewal, the services offered may be combined differently than indicated here. They may also vary depending on the year of production of the vehicle. The services mentioned correspond to the third generation of SEAT CONNECT. »

SEAT CONNECT services and functions that do not require activation

The following services also work without the activation of SEAT CONNECT:

- Public emergency call service.
- Privacy mode.
- Legal.

SEAT CONNECT services

The SEAT CONNECT services are:

- Private emergency call
- Public emergency call
- Roadside assistance call
- Customer support
- Service appointment planning
- Online system update
- Customisation
- Activating SEAT CONNECT
- Private mode (deactivation of services)
- Delete user / Reset factory settings
- Remote independent heating
- Remote opening
- Horn and turn signals
- Vehicle status incl. doors and lights
- Driving data
- Vehicle status report
- Anti-theft alarm warning

- Zone warning
- Speed warning
- Online map update
- Search for points of interest
- Petrol stations
- Online traffic information
- Parking lots
- Online infotainment system update
- Online route calculation
- Information on risks
- Dictation
- Natural voice control for destinations and addresses
- Online radio
- Online media
- Online route import
- Online destination import
- Remote auxiliary ventilation
- Parking position
- Privacy mode
- Legal

SEAT CONNECT services for hybrid vehicles

Available only in electric and hybrid vehicles.

- Remote air conditioning
- Electrical power manager

- Departure times
- plus all SEAT CONNECT services in the previous section »» page 158.

SEAT CONNECT individual options

- In-Car Applications. These applications can be purchased and installed directly in the infotainment system through the In-Car store.
- Full Link.
- Data package. Pay per use data rates for the use of online functions, for example, 2 GB per month.

Note

- The public emergency call service is available regardless of whether the infotainment system is logged in.
- Customisation and purchase of In-Car applications require logging into infotainment system, but the activation of the vehicle in a SEAT CONNECT account is not necessary.

Activation of SEAT CONNECT and S-PIN

Activating SEAT CONNECT

The following steps are necessary for the activation of SEAT CONNECT (including registration):

- Create a user account at <https://my.seat> or directly through the infotainment system in the User Management menu.
- Place the SEAT CONNECT order and activate it.
- Add the vehicle to your user account.
- Prove ownership.
- Prove your identity. It is only necessary if you are to run SEAT CONNECT services relevant to security.
- You can activate it at <https://my.seat> or directly through the infotainment system. To activate it through the infotainment system, proceed as follows:

8" **HOME > User management > Become a main user.**

6.5" **MENU > Settings > SEAT Connect > Settings**

Follow the rest of the indications and the information shown in the infotainment system. During activation, you may be asked to create an S-PIN.

Update option

8" Infotainment	yes
6.5" Infotainment	yes
SEAT CONNECT portal	yes
SEAT CONNECT application	yes

More information at <https://my.seat/faqs>.

S-PIN

The S-PIN is a sequence of several digits, which can be selected when completed the SEAT CONNECT registration.

When creating the S-PIN, avoid easy-to-guess number sequences and known dates of birth. You can change the S-PIN in the SEAT CONNECT user account in "Account settings".

The S-PIN is necessary, for example, to protect your user profile or to run a SEAT CONNECT service relevant to the security of your vehicle.

You must manage this S-PIN with absolute confidentiality. If you reveal the S-PIN to third parties, for security reasons you must change it immediately.

Ownership and identity accreditation

Depending on the Infotainment system, the ownership accreditation method will be the 2-key method or the registration code method.

8" Infotainment system

To become a main user and thus prove ownership of the vehicle, you need both of the vehicle's physical keys. Ownership accreditation takes place in the vehicle during registration or, if you already have a SEAT CONNECT user account, you must log in through the infotainment system and then go to **User management**

- Switch on the ignition and the infotainment system.
- In the infotainment system, register in SEAT CONNECT.
- **Or:** open the menu **User management > Settings > Become main user** and follow the instructions.
- Press the unlock button on the first vehicle key.
- Press the unlock button on the second vehicle key.

6.5" Infotainment system

To become the main user and therefore accredit ownership of the vehicle, you will need the registration code found on the SEAT Web Portal and in the APP after linking the vehicle to your account (**My Garage > Add Vehicle > Accept terms and conditions and SEAT privacy policy**). Ownership is accredited inside the vehicle. Go to **Vehicle settings > SEAT CONNECT > Registration** and enter »

the registration code shown on the Web Portal or in the App.

Once the infotainment system has processed the orders by radiofrequency, the accreditation of the ownership will have been completed. You can control the current status in the SEAT CONNECT portal.

How is ownership accredited?

8" Infotainment	2-Key method.
6.5" Infotainment	Registration code
SEAT CONNECT portal	No, it is not possible
SEAT CONNECT application	No, it is not possible

Identity accreditation (SEAT Ident)

Identity accreditation must be done before you can use SEAT CONNECT services that are relevant to security, such as the "Remote Opening" service. Identity accreditation can be done in two ways:

- In person at the SEAT dealership.
- You can find more information about SEAT Ident on the SEAT CONNECT portal at <https://my.seat>.

Legal provisions

During the use of SEAT CONNECT services, information is transferred and processed online through the vehicle. Such data can also provide (at least indirectly) information about the driver in question, for example, driving behaviour and location. As a contracting party in the SEAT CONNECT contract with SEAT, S.A., you must ensure that when your vehicle is used by other drivers (for example, family or friends), data protection and personal rights are respected. Therefore, you must inform drivers in advance that the vehicle transfers and receives data online, and that you can access such data.

Not taking into account this obligation to inform, can infringe certain rights of the occupants.

Users can manage data sending and transfers through the privacy mode at any time. More information at: <https://my.seat/faq>.

Follow-up services: ask all occupants

The follow-up services need geographical and vehicle data to determine whether the vehicle is being used within defined speed ranges, where it has been parked or if it is being used in an established geographical area. This information is displayed on the SEAT CONNECT portal and in the SEAT CONNECT app.

Therefore, before moving off, ask all the vehicle occupants if they agree with the activated services. If they do not, deactivate the service in question (if possible) or do not allow the occupants to use the vehicle.

GPS tracking: marking

If the vehicle has a factory-assembled control unit that transmits the its current geographical position and speed, the vehicle usually has this GPS marking (e.g., on the roof console). The absence of the marking on the vehicle does not guarantee that the control unit does not transmit the vehicle's current geographical position and speed.

Personal information

SEAT protects your personal data and only uses them, as long as the law allows it or you have given your consent on the occasion of a use. You will find detailed information on data processing in relation to SEAT CONNECT services in the Privacy Policy, which you can access in its corresponding current version on the SEAT website.

Permanent transfer of the vehicle

If another person has left you the vehicle for permanent use (for example, if you buy a used vehicle), SEAT CONNECT may already be activated and the previous user still has

the possibility of accessing the data registered through SEAT CONNECT and control certain functions of your vehicle.

In the infotainment system you can check if your vehicle is assigned to a person as the main user. In this case, you can register yourself as the main user of the vehicle and thus automatically delete the previous main user. Alternatively, through the infotainment system you can directly and permanently delete the previous user as the main user, as well as put the vehicle in offline mode and thus limit both the communication of your vehicle with the SEAT, S.A. data server and the processing of personal and vehicle data.

Deactivating SEAT CONNECT services

The following functions are available in the infotainment system to deactivate and activate SEAT CONNECT services:

- Central deactivation or activation
- Individual deactivation or activation

You can rerun the corresponding services after cancelling their deactivation in the infotainment system.

Note

The services required by law and their data transmission, such as the public emergency call system, cannot be disconnected or deactivated.

Faults

Even if the prerequisites for the use of SEAT CONNECT services are met, there may be factors beyond the control of SEAT, S.A. that interfere with the execution of such services or prevent them. These may be specifically:

- Maintenance, repair, deactivation, software update and technical expansion of telecommunication equipment, satellites, servers and data banks.
- Change of the mobile telephony standard for the transmission of mobile data by the telecommunications service provider, for example, from UMTS to EDGE or GPRS.
- Disconnection of an existing mobile phone standard by the telecommunications service provider.
- Interference, disturbance or interruption in the reception of the mobile phone and GPS signal due to aspects such as high-speed driving, solar storms, meteorological influences, topography, blocking equipment and the intensive use of mobile phones in the radio cells in question.

- When in areas with zero or insufficient mobile telephony or GPS signal. Also, for example, in tunnels, confined areas between very tall buildings, garages, underpasses, mountains and valleys.
- External information from third party supplies available with limitations, incomplete or incorrect, e.g. representations of maps.
- Countries and regions where SEAT CONNECT is not offered.

Service management

Open the settings in **Users** and go to **Privacy and Services**. In vehicles equipped with a Media System (6.5") it is accessed from **Settings > SEAT Connect > Privacy settings and services**. You can do the following in the infotainment system:

- Check which SEAT CONNECT services are currently available in the vehicle.
- The number of SEAT CONNECT services that are enabled or disabled.
- Activate or deactivate SEAT CONNECT services.

More information at <https://my.seat>.





Privacy and Services Settings

SEAT CONNECT services can be activated and deactivated individually. To do this, just »

check the box corresponding to the service you want to activate or deactivate. Use the privacy mode option if you want to deactivate all of the services at the same time.

Privacy mode

Allows you to deactivate or activate the services depending on the selected privacy level.

 Tracking	Share location. Main users and co-users can view position data on the SEAT CONNECT portal or app.
 Location	Use location. Position, vehicle, and user data are used for services.
 Personal	No location. Only the vehicle data and user data are used for services.
 Incognito	Maximum privacy. Your services are disabled. Only services required for legal reasons use data.

Setting options are not available in all markets or in all vehicle models.

Note

If you deactivate each and every SEAT CONNECT service, the OCU may continue to transmit data.

Full Link

Introduction

With Full Link it is possible to view and use the contents and functions that are shown on the mobile phone device on the infotainment screen.

To do this, the mobile phone device must be connected with the infotainment system through a USB interface.

Some technologies can also be used by Wireless Full Link through the Bluetooth® interface and a Wi-Fi connection.

The following technologies may be available:



- Apple CarPlay™
- Apple CarPlay™ Wireless
- Android Auto™
- Android Auto™ Wireless
- MirrorLink®

The availability of the technologies that Full Link includes depends on the country and the mobile phone device used.

You will find more information on the SEAT website (www.seat.com).

Access the Full Link main menu

Browsing the Full Link main menu depends on the infotainment system used.

- View : click on **Full link**
- View : click on **Menu > Full Link**
- **OR:** press **APP**.

Configure Wireless Full Link

In order to use Wireless Full Link, you must first pair the mobile phone device with the infotainment system. To do this, proceed as follows:

Connect a mobile phone device for the first time.

- Unlock the mobile phone device.
- Enable Wi-Fi reception and Bluetooth® on the mobile phone device.
- Connect the mobile phone device to the infotainment system using a USB cable or via Bluetooth®.
- Access the Full Link main menu, unless it appears automatically.
- Select the mobile phone device and the technology you want.
- Confirm authorisation inquiries on the mobile phone device to grant the necessary authorisations to the infotainment system.
- Disconnect the USB connection and connect with the infotainment system again via

Wi-Fi or Bluetooth®. Wireless Full Link is now configured.

The pairing has concluded. The connected mobile phone device can also use Wireless Full Link from now on without the USB connection.

If pop-up menus are rejected during the connection process, Wireless Full Link will not be available. In this case, SEAT recommends removing the devices in both the iPhone settings and the infotainment system, and restarting the connection process.

WARNING

The use of applications while driving can distract your attention from the traffic. Any distraction affecting the driver in any way can lead to an accident and cause injuries.

- Always drive as carefully and responsibly as possible.

WARNING

Any applications that are not suitable or execute incorrectly may cause damage to the vehicle, accidents and serious injuries.

- Protect the mobile phone device and its applications from inappropriate use.
- Never carry out modifications to the applications.
- Follow instructions in the instruction manual for the mobile phone device.

CAUTION

SEAT cannot be held liable for any damage caused to the vehicle as a result of the use of applications that are of poor quality or are defective, the inadequate programming of the applications, the insufficient coverage of the network, the loss of data during transmission or the improper use of mobile phone devices.

Note

Wireless Full Link may not be compatible with all technologies.

Applications (apps)

With SEAT Full Link, the display of the contents of SEAT applications and other providers installed on mobile phone devices can be transferred to the infotainment screen.

In the case of third-party applications, there may be compatibility problems.

Applications, their use and the necessary mobile phone connection may be pay per use.

The offer of applications can be varied and designed for a vehicle or a specific country. The content and volume of applications, as well as the companies that offer them, may



vary. Some applications also depend on the availability of third-party services.

It cannot be guaranteed that all the applications offered will work on all mobile phone devices or with all their operating systems.

The applications offered by SEAT can be modified, cancelled, deactivated, reactivated and extended without prior notification.

To avoid distracting the driver while driving, only certified applications can be used.

Full Link symbols and settings

-  To show more information
-  To open the Full Link settings menu

Apple CarPlay™

In order to use Apple CarPlay, the following requirements must be met:

- The iPhone™ **must** be compatible with Apple CarPlay™.
- Voice control (Siri™) **must** be active on the iPhone™.
- Apple CarPlay™ **must** be active without limitations in the iPhone™ settings.



- The iPhone™ **must** be connected to the infotainment system via a USB connection. Only USB connections with data transmission are suitable for the use of Apple CarPlay™.
- The USB cable used **must** be an original Apple™ cable.

Apple CarPlay™ Wireless: Bluetooth® and Wi-Fi must also be activate on the iPhone™.

Establish connection

When you first connect an iPhone™, follow the instructions on the infotainment system screen and on the iPhone™.

The requirements must be met to use Apple CarPlay™.

Launch Apple CarPlay™:

- Press **HOME > Full Link** to access the Full Link main menu.
- **OR:** press **APP** to access the Full Link main menu.
- Press Apple CarPlay™ to establish a connection with the iPhone™.

Disconnecting

- On the Apple CarPlay™ mode, press the **SEAT** icon to access the Full Link main menu.
- Press **X** to interrupt the active connection.

The representation of function buttons on the screen may vary.

Special characteristics

During an active Apple CarPlay™ connection, the following characteristics are applicable:

- Bluetooth® connections between the iPhone™ and the infotainment system are not possible.
- If there is an active Bluetooth® connection, it is automatically interrupted.
- The phone functions are only available through Apple CarPlay™. The functions described for the Infotainment system are not available.
- The connected iPhone™ cannot be used as a multimedia device in the Media main menu.
- It is not possible to use the built-in navigation system and the Apple CarPlay™ navigation system at the same time. The last route started interrupts the one that was previously active.
- Depending on the infotainment system you use, on the instrument panel screen you can view data from the Telephone mode.
- The instrument panel screen does not display any indication to turn.
- With the multifunction steering wheel you can accept or reject incoming calls, as well as end an ongoing telephone conversation.

voice control

- Press **Ω** briefly to start voice control using the infotainment system.

- Press this button for a long time to start voice control (Siri™) of the connected iPhone™.

Note

- **The availability of technologies depends on the country and may vary.**
- **You will find information about technical requirements, compatible iPhones, certified applications and their availability on the SEAT (www.seat.com) and Apple CarPlay™ websites, or at SEAT dealerships.**

Android Auto™

Requirements for Android Auto™

In order to use Android Auto™, the following requirements must be met:

- The mobile phone device, called smartphone from here on, has to be compatible with Android Auto™.
- The smartphone must have an Android Auto™ application installed.
- The smartphone has to be connected through the USB connection with data transmission with the infotainment system.
- The USB cable used must be an original cable provided by the smartphone manufacturer.

Android Auto™ Wireless: Bluetooth® and Wi-Fi also have to be activated on the device.

Establish connection

When you first connect a smartphone, follow the instructions on the infotainment system screen and on the smartphone.

The requirements must be met to use Android Auto™.

Launch Android Auto™:

- Press **HOME > Full Link** to access the Full Link main menu
- **OR**: press **APP** to access the Full Link main menu.
- Press Android Auto™ to establish a connection with the smartphone.

Disconnecting

- On the Android Auto™ mode, press the **Return to SEAT** icon to access the Full Link main menu.
- Press **X** to interrupt the active connection.

Special characteristics

During an active Android Auto™ connection, the following characteristics are applicable:

- An active Android Auto™ device can be connected at the same time via Bluetooth® (HFP profile) with the infotainment system.

- It is possible to use the phone's functions through Android Auto™. If the Android Auto™ device is connected at the same time via Bluetooth® with the infotainment system, the telephone function of the infotainment can also be used.

- An active Android Auto™ device cannot be used as a multimedia device in the Media main menu.

- It is **not** possible to use the built-in navigation system and the Android Auto™ navigation system at the same time. The last route started interrupts the one that was previously active.

- On the instrument panel screen you can view data from the Telephone mode.

- The instrument panel screen does not display any indication to turn on the Media mode.

- With the multifunction steering wheel you can accept or reject incoming calls, as well as end an ongoing telephone conversation.

voice control

- Press **Ω** briefly to start voice control using the infotainment system.
- Press this button for a long time to start voice control on the connected smartphone.

Note

- **The availability of technologies depends on the country and may vary.**
- **You will find information about technical requirements, compatible mobile phone devices, certified applications and their availability on the SEAT (www.seat.com) and Android Auto™ websites, or at SEAT dealerships.**

MirrorLink®

Requirements for MirrorLink®

In order to use MirrorLink™, the following requirements must be met:

- The mobile device must be compatible with MirrorLink™.
- The mobile phone device must be connected to the infotainment system via a USB connection that is suitable for data transmission.
- The USB cable used must be an original cable provided by the mobile phone device manufacturer.
- Depending on the mobile phone device used, a Car-Mode application that is suitable for using MirrorLink® must be installed.

Establish connection

When you first connect a mobile phone device, follow the instructions on the




infotainment system screen and on the mobile phone device.

The requirements must be met to use MirrorLink™.

Launch MirrorLink®:

- Press **HOME > Full Link** to access the Full Link main menu.
- **OR:** press **APP** to access the Full Link main menu.
- Press to establish the connection with the mobile phone device.

Disconnecting

- In the MirrorLink® mode, press the **APP** icon to access the Full Link main menu.
- **OR:** press  to access the MirrorLink® main menu.
- Press **X** to interrupt the active connection.

Special characteristics




During an active MirrorLink® connection, the following characteristics are applicable:

- An active MirrorLink® device can be connected to the infotainment system at the same time via Bluetooth®.
- If the MirrorLink® device is connected to the infotainment system via Bluetooth®, the telephone function of the infotainment system can be used.

- You cannot use an active MirrorLink® device as a multimedia device in the Media main menu.
- On the instrument panel screen you can view data from the Telephone mode.
- The instrument panel screen does not display any indication to turn on the Media mode.
- With the multifunction steering wheel you can accept or reject incoming calls, as well as end an ongoing telephone conversation.

Function buttons

Function buttons and their function:

- APP** Return the Full Link main menu. Here you can end the MirrorLink® connection, connect another mobile phone device or select another technology.
- X** Press to close the open apps. Then press the apps to be closed or the **Close all** function button to close all the open applications.
-  Press to display the mobile phone device screen on the infotainment system screen.
-  To open the MirrorLink® settings.
-  Press to return to the MirrorLink® main menu.

Note

You will find information about technical requirements, compatible mobile phone devices, certified applications and their availability on the SEAT (www.seat.com) and MirrorLink® websites, or at SEAT dealerships.

WLAN access point*

Introduction

✓ Not available for model: Media System

The infotainment system can be used to share a WLAN connection with up to 8 devices »» page 167, Configuration for sharing a connection over WLAN.

The infotainment system can also use the WLAN hotspot of an external device to provide Internet to the devices connected to the hotspot (WLAN client) »» page 167.


Note

- **Data transmission may incur charges. Due to the high volume of data exchanged, SEAT recommends the use of a flat rate tariff for data transmission. Mobile phone operators can provide the relevant information.**
- **The exchange of data packages may generate additional costs, depending on**

your mobile phone rate, particularly if you are abroad (for example, roaming rates).

Configuration for sharing a connection over WLAN

Establishing the connection with the wireless network (WLAN)

- Pulse the **HOME** >  button.
- Activate the wireless network. To do so, press the **WLAN** function button.
- Activate the wireless network (WLAN) on the device that is to be connected. If necessary, refer to the manufacturer's instruction manual.
- Activate the mobile device assignment in the infotainment system. To do so, press the **Enable WLAN connection** button and activate the checkbox.
- Enter and confirm the network key displayed on the device.

The following settings can also be made on the menu **Share connection**:

- **Security level:** WPA2 encryption automatically generates a network key.
- **Network key:** Network key automatically generated. Press the function button to manually change the network key. The network

key must have a minimum of 8 characters and a maximum of 63.

- **SSID:** WLAN Network name (maximum of 32 characters).

The wireless (WLAN) connection is established. To complete the connection, it may be necessary to enter other data into the device.

Repeat this process to connect other devices.

Wi-Fi Protected Setup (WPS)

✓ *This depends on the equipment and the country in question.*

Wi-Fi Protected Setup can be used to create a ciphered local wireless network quickly and simply.


- Establish the connection with the wireless network (WLAN).
- Press the **WPS** button on the WLAN router until the warning light on the router starts flashing. If the WLAN router does not support WPS the network must be configured manually.
- **OR:** Press and hold the **WLAN** button on the WLAN router until the **WLAN** light on the router starts flashing.
- Press the **WPS** button on the WLAN device. The wireless (WLAN) connection is established.

Repeat this process to connect other devices.

Configure Internet access

The infotainment system can use the WLAN hotspot of an external device to establish an Internet connection.

Establishing the connection with the wireless network (WLAN)

- Activate and check the wireless hotspot on the external device. If necessary, refer to the manufacturer's instruction manual.
- Press the **HOME** >  button; **OR** access the **Media** mode and press the **Settings** menu.
- Press on the menu **WLAN** > **Enable WLAN connection** and check the verification box.
- Press the **Find** function button and select the device you want from the list.
- If necessary, enter the network key of the device in the infotainment system and confirm with **OK**.

Manual settings:

- To manually enter the network settings of an external (WLAN) device.

The wireless (WLAN) connection is established. To complete the connection, it may be necessary to enter other data into the device. »

Note

Due to the large number of devices on the market, it is not possible to guarantee fault-free operation of all functions.

Infotainment operation

voice control*

Introduction

The voice control works both online* and offline taking into account what is indicated in **page 169, Languages available depending on the market**. In online* mode, commands are recorded more accurately, as more data is available.

Voice control understands questions and expressions without having to learn commands. Commands can be formulated freely and can be colloquial. You will find proposals for commands in the infotainment system.

Functions are reduced in offline mode.

Loud noises inside or outside the vehicle can cause malfunctions, as well as confusing phrases and answers.

Languages available depending on the market

Online and offline:* German, American English, British English, French, Italian, Spanish and Czech. These languages have advanced functions such as Online Commands, air conditioning control, natural interaction, etc.

The other languages of the infotainment system **do not** offer Online Commands, air conditioning control or natural interaction.

Requirements

- *Online* and offline:* voice control with the corresponding infotainment mounted on the vehicle.
- *Online** current SEAT CONNECT Plus contract active.

Note

- **Voice control only recognises commands in the language that is set in the infotainment system.**
- **Test the voice control with the vehicle stopped before starting to move to familiarise yourself with its operation.**

Activation word and commands

Voice control activation words

If you have connected the voice control via the activation word, the connected infotainment responds with **How can I help you?** It then scans the words spoken in the vehicle after the activation word.

Voice control starts when the infotainment recognises the activation word.

Connect and disconnect the activation word

- In **HOME** press **Settings > Voice control > Activate/ deactivate activation word**.

Activation word:

Hola Hola

Commands

For voice control to recognise commands reliably, bear in mind the tips for the commands to work properly.

Tips for the commands to work correctly:


- Pronounce clearly. Confusing commands are not recognised. Talk in a normal tone of voice. Speak a little louder if you are driving at high speed.
- Avoid outside noises. Open windows and doors can interfere with voice control.
- Avoid other secondary noises, such as conversations in the vehicle. Do not direct the air flow from the outlets towards the microphone or the interior lining of the roof.
- Do not use a very strong accent or dialect.
- Do not make long pauses.



Voice control is active and recognises the words pronounced.




Note

- When the activation word is disconnected, the infotainment system cannot be activated by means of the activation word. Voice control is still available via the  button on the multifunction steering wheel.
- Availability depends on country and equipment.
- Depending on the content of the phone book and to ensure reliable recognition of the names of the phone book, it may be useful to change the order of the first and last name of the contact in question.

Start and stop voice control

Depending on the equipment, you can start voice control in different ways.

Start voice control


- *Voice control activation:* say the word that activates voice control.
- *Multifunction steering wheel:* press the voice control button .

The voice control ends automatically, if you use infotainment functions, if the parking system is activated or by incoming calls.

In some cases you can also start voice control of the connected mobile phone device, by pressing and holding the voice control button.

Manually ending voice control

Voice control can be cancelled with the **Cancel** command.

- *Multifunction steering wheel:* press the voice control button  twice in a row, or a long press.

Radio/Multimedia

Radio mode

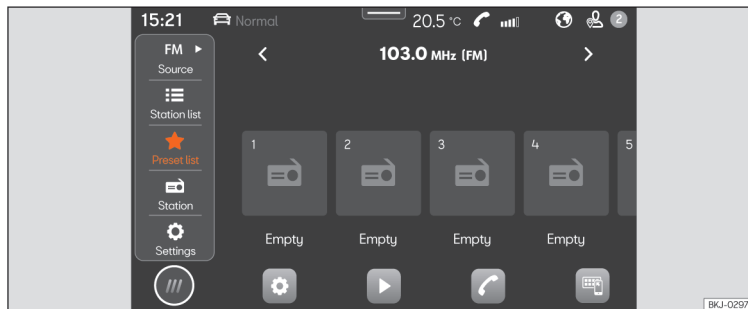


Fig. 130 Schematic representation: Radio view

In Radio mode you can tune in the available radio stations in different frequency bands and memorise your favourites on the preset buttons to access them quickly.

The types of reception and frequency bands available depend on the equipment and the country. In certain countries, frequency bands may stop broadcasting or not be available again.

Access the RADIO menu

- Press **HOME** > >>> **Fig. 130**.

Access the settings

- Press **HOME** > > .

Online* functions in Radio mode

Online* functions in Radio mode are only available under the following conditions:

- SEAT CONNECT or SEAT CONNECT Plus equipment.
- You have an active SEAT CONNECT user account.
- Add the vehicle is assigned to your user account.

- You have a corresponding data package acquired from the In-Car store or have a data volume for your own mobile phone device via Wi-Fi access point.

Note

- **For streaming services you need to have an account with the provider in question.**
- **Radio stations are responsible for the content of the information they transmit. Additional electrical equipment connected to the vehicle can cause interference in the reception of the radio signal and noise in the speakers.**

»

- Foil or metal-coated stickers attached to the windows may affect reception on vehicles with a window aerial.

Radio equipment and symbols

The functions, as well as the types of reception and frequency bands available depend on the equipment and the country.

- AM* tuner.
- Dual FM receiver (diversity antenna).
- Summarised FM station list.
- Fusion of DAB* and FM stations into one list.
- Fusion of all stations stored in preset buttons into one list. Maximum 36 favourite stations.
- Station logos.
- DAB presentation (slideshow). Images that are emitted sequentially.
- Online* radio.

Universal symbols in Radio mode


AM To select the desired AM frequency band.

FM/DAB To select the desired FM/DAB frequency band.

Online radio* To select the type of Online* radio reception.

TP Next to the name of the station, monitoring of active traffic information stations (TP).

Symbols on the FM/DAB frequency band


 To display the frequency band for manual selection of the FM frequency. Only possible when the summary station list is disconnected.

 DAB not available.

 DAB stations support presentations (slideshow).

Symbols on the AM frequency band


 Manually updating the station list.


 To display the frequency band for manual selection of the AM frequency.


Menus in Online* radio mode


 Show station selection.


 Open text search.


 Show the last online radio stations heard.

 Show the 100 most heard online radio stations.

 Show available online radio podcasts.

 Show online radio stations, which originate from the desired country.

 Show online radio stations, which broadcast in the desired language.

 Show online radio stations whose programme belongs to the desired musical genre.

Selecting, tuning and saving a station

Select the frequency band

Before selecting a station you have to select a frequency band or a type of reception. Different stations are available depending on the frequency band selected or the type of reception.

The types of reception and frequency bands available depend on the equipment and the country.

- Select the frequency band or type of reception: AM*, FM/DAB, FM (for devices that do not have DAB), Online* radio.

Search and select a station

You can select radio stations in different ways. The options vary depending on the frequency band and the type of reception.

Select via the frequency band (AM and FM)

- Activate the frequency band.

- Click on the cursor, scroll through the frequency band and release it when you reach the frequency band you want.
- **OR:** press on a point on the frequency band. The cursor will automatically jump to the corresponding frequency.

The station of the set frequency is tuned.

Select from the station list (AM and FM/DAB)

The station list shows the stations that are currently tunable. In the AM frequency band, you may have to update the station list if you are no longer in the area where you last accessed the station list. In the FM/DAB frequency band, the station list is automatically updated.

- Open the station list
- Press the station you want.

The selected station is tuned. In the case of FM/DAB and if the station is available, the best quality reception is automatically selected.

Search and filter stations (Online* radio)

In Online Radio mode, stations can be filtered by categories and can be searched by text.

- Open the station list.

- Select the category by which the stations are to be filtered.
- **OR:** press **Q** to start the text search. The input field is displayed.
- Enter the name of the station you want. The list of the stations found is updated while entering the text.
- Press the station you want.

The selected station is tuned.

Search in SCAN mode (AM and FM/DAB)

In SCAN mode the stations are automatically tuned in a sequential manner and each of them is played for approx. 5 seconds.

- To start the SCAN mode, under **Settings** press **SCAN**.

SCAN mode starts and the station currently tuned in is shown on the screen. Next to it is a SCAN function button.

- To select a station press SCAN.

SCAN mode stops and the station is tuned. The SCAN function button is hidden.

Storing the station on the preset buttons

You can store up to 36 stations of different frequency bands and reception types as favourites using the preset buttons.

- Tune the station you want.

- Access the preset buttons.
- Press the preset button and keep it pressed until the station is stored.
- **OR:** press the station on the station list and keep it pressed. The preset buttons are displayed.
- Press the preset button.

The station is stored in the selected preset button.

If a station was already stored in the preset button, it is overwritten with the new station.

Special functions in Radio mode

(TP) Traffic information

The TP function monitors the announcements of a station with traffic information and automatically reproduces them in the Radio mode or in the multimedia playback that is active. To do this, you have to be able to tune into a station with traffic information.

Some stations without their own traffic information support the TP function by broadcasting traffic information from other stations (EON).

In the AM frequency band or in the Multimedia mode, a station with traffic information in the background is automatically tuned while »

it is possible to tune into a station with traffic information.

If no station with traffic information can be tuned in, the device automatically searches for stations with tunable traffic information.

Stations with traffic information are not available in all countries.

Activating and deactivating the TP function

- In Radio mode or Multimedia mode, press **Settings > Traffic station [TP]**.

Online* radio

Online radio is a type of reception for Internet radio stations and podcasts that are independent of AM, FM and DAB. Thanks to Inter-

net transmission, reception is not limited to the region.

Online radio is only available through the Internet connection of the active infotainment system. The use of online radio can generate expenses due to the transmission of data from the Internet.

- In Online radio mode, press and set the audio quality to high or low to tune the online radio.


Station logos

In the case of some frequency bands, station logos may already be pre-installed in the infotainment system.

If in the FM/DAB frequency band settings the **automatic selection of station logos** is activated, station logos are automatically assigned to the stations.

In the Online radio mode, the infotainment system accesses the station logos of the online database and automatically assigns them to the stations

Assign station logos manually

- In FM/DAB mode, press **Station logos**.
- Press on the  icon and then select the station to which a station logo is to be assigned.
- Select the station logo. If desired, repeat the same process with other stations.
- **OR**, via the menu **Settings > Station logos**.

Media Mode

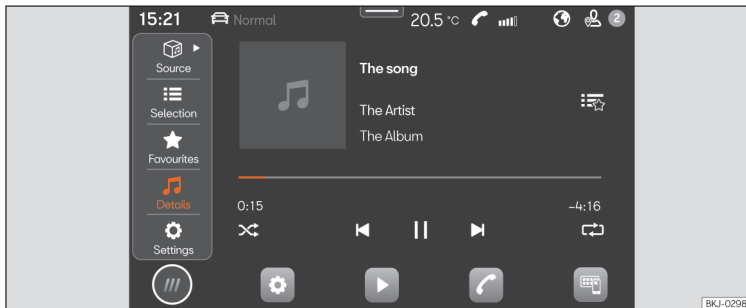


Fig.131 Schematic representation: Multimedia view

In Media mode you can play multimedia files from data media and streaming services through the infotainment system.

Depending on the equipment, the following data media can be used:

- USB storage support (for example, a USB stick, a mobile phone connected via USB).
- Bluetooth® device (for example, a mobile phone or a tablet).

Depending on the equipment, the following types of multimedia files can be played:

- Audio files.
- Video files (depends on the system).

You can also use streaming services. The availability of streaming services depends on the equipment and the country.

To use streaming services you need to have your own user account in the streaming service in question.

Access the MEDIA menu

- Press **HOME** > ► >>> **Fig. 131**.

Access the settings

- Press **HOME** > ► > ⚙️.

Limitations and indications of data media

Data media may not work if they have been exposed to high temperatures or have been

damaged. Please bear in mind the manufacturer's indications.

Quality differences between data media produced by different manufacturers can cause multimedia playback malfunctions.

Incorrect configuration on a data media may cause the data media to be unreadable.

Playlists only specify a playback order and refer to the storage location of the multimedia files within the folder structure. In a playlist there are no multimedia files saved. To play a playlist, multimedia files have to be found in the storage places of the data media to which the playlist refers. »

Equipment features. Audio, multimedia and connectivity:

- Multimedia playback and control via Bluetooth®.
- Audio playback in these formats: AAC, ALAC, AVI, FLAC, MP3, MP4, WMA.
- Video playback in these formats: MPEG-1 and MPEG-2 (.mpg, .mpeg), ISO MPEG4, DivX 3, 4 and 5 Xvid (.avi), ISO MPEG4 H.264 (.mp4, .m4v, .mov), Windows Media Video 10 (.wmv, .asf).
- Playlists on any type of device.
- Multimedia streaming (online*).
- Multimedia search.

Note

SEAT assumes no liability for any deterioration or loss of files on data storage devices.

Select and play a multimedia source

Select multimedia source

Before playing multimedia files you must first connect a multimedia source.

To use streaming services you must be connected to the Internet.

- Connect an external multimedia source.


- Select the connected media source to be used for playback.

Playing audio and video files

You can search and play multimedia files from an available multimedia source in different ways.

Search in the folder structure

Multimedia files can be catalogued by categories (for example, album, artist, title). In **My Multimedia** this category view is always displayed. The classic folder structure of individual USB data media is also found in **My Multimedia**.


- Activate the folder structure.
- The folder structure of the selected multimedia source is displayed. When **My multimedia** is selected, the categories (music, videos, playlists) and connected multimedia sources are displayed first.
- Search for the title you want in the folder structure.
- **Or:** press  to start the text search. The input field is displayed.
- Enter the name of the desired title. The list of the titles found is updated while entering the text.
- Press the desired title.
- If at the beginning of the playback your selection is in a folder of a multimedia source,

the multimedia files that are in it are also added to the playback.

- If a playlist is played, all available titles in the playlist are added to the playback.
- Close your selection with **X**.

Select favourites


In favourites you can save titles, music genres, artists and albums individually for playback.

- Access favourites .
- Press the favourite you want.

Depending on your selection, all the titles belonging to the favourite are added to the playback.

Configure streaming services

Depending on the equipment you can use streaming services directly through the infotainment system. For this you need to have a premium user account of the streaming service in question and you have to log in with it in the infotainment system. You also need to be connected to the Internet.

- Select  **Streaming** as the multimedia source.
- A list of available streaming services is displayed.
- Select the streaming service you want.

- Follow the steps indicated by the infotainment system.
- The streaming service is added to the list of multimedia sources as a new function button.

Save favourites

Only multimedia files in **My multimedia** of the infotainment system can be saved as favourites. You can save up to a maximum of 30 titles, albums, artists and music genres individually as favourites.

- Start playback.
- Access favourites.
- Tap a favourite that is not assigned.
- **Or:** click on an existing favourite and press and hold for approx. 3 seconds.
- Select from the selection list: Title, Album, Artist, Musical genres.

- Playlist.

The selection is saved instead of the previously selected favourite. If the favourite was already assigned, the previously saved favourite is overwritten.

The selectable options in the selection list depend on the data attached to the multimedia file. If the music genre is not indicated in the music files, for example, you cannot save the music genre as favourite.

If a video file is playing, only that video can be saved as favourite.

Playing entertainment content in the infotainment system

Depending on the infotainment system, videos can be played.

Video mode

When in video mode, a video can be played on the infotainment screen if this is stored on a data media, in **My Multimedia** or is sourced from a streaming service. In this case, the video sound is played through the vehicle's speakers.

The image is only displayed if the vehicle is stopped. When the vehicle is in motion, the infotainment screen turns off. The sound of the video can still be heard.

A stable Internet connection is required for playback from a streaming service. In this case, telephony costs may be generated.

Navigation*

Introduction

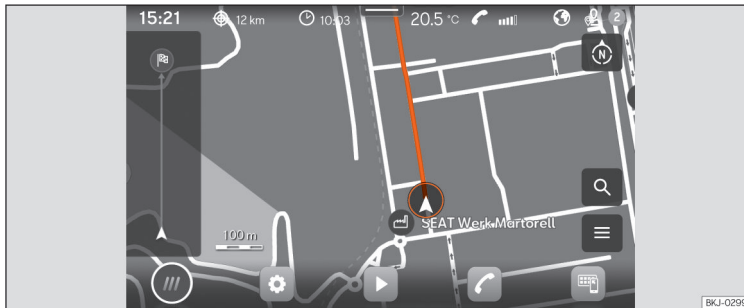


Fig. 132 Schematic representation: Navigation view

A global satellite system determines the current position of the vehicle and the sensors mounted on the vehicle analyse the routes taken. All measured values and possible traffic events are compared with the available maps to allow optimal navigation to the destination.

Navigation announcements and graphic representations will guide you to your destination.

Navigation management is carried out on the screen.

Depending on the country, some functions of the infotainment system will not be available

on the screen when travelling above a certain speed. It is not a malfunction, but is due to compliance with legislation.

Navigation announcements

Navigation announcements are acoustic indications for driving referred to the current route.

The type and frequency of navigation announcements depend on the driving situation, for example, starting the guide to the destination, driving on the motorway or on a roundabout and the settings.

If the exact destination cannot be reached because, for example, it is in a non-digitised area, indications relating to the address and the distance to the destination are displayed on the screen.

During dynamic route guidance, you will receive information about reported traffic congestion on the route. An additional navigation announcement is provided if the route is recalculated due to traffic congestion.

While a navigation announcement is playing, its volume can be adjusted. The following navigation announcements provided will be played with the newly adjusted volume.

Limitations during navigation

If the infotainment system cannot receive data from GPS satellites, for example, in a tunnel or in an underground garage, navigation continues using the vehicle's sensors.

In areas that are not digitised or are only partially digitised on the infotainment memory, the infotainment system will still attempt to provide route guidance.

In the case of missing or incomplete navigation data, it may not be possible to determine the exact position of the vehicle. This may mean that navigation is not as precise as usual.

Roads and streets are subject to constant change (e.g. new roads, road works, roads closed to traffic, changes to street names and building numbers). If the navigation data is obsolete, this may lead to errors or inaccuracies during the route guidance.

Managing the navigation map

To allow an optimal view, you can also manage the navigation map with additional finger movements.

Move the map *(tip: use your index finger).*

- Move the map with your finger.

Zoom in the view *(tip: use your index finger).*

- To increase the view in a certain position, double-click on the map.

Zoom out the view *(tip: use your index and middle fingers).*

- Press on the map with both fingers at the same time.

Change view *(tip: use your index finger).*

- Press twice on the map and keep your finger pressed on the screen.
- To zoom out the view of the map, move your finger upwards. To zoom in the view of the map, move your finger downwards.

Change view *(tip: use your index and middle fingers).*

- Press on the map with both fingers at the same time and keep them pressed.
- To zoom out the view of the map, move one finger towards the other. To zoom in the view of the map, move one finger away from the other.

Tilt the view *(tip: use your index and middle fingers).*

- Press on the map with both fingers at the same time and horizontal to each other, keep them pressed.
- To tilt the view of the map forward, move your fingers upwards. To tilt the view of the map backward, move your fingers downwards.

Rotate view *(tip: use your index and middle fingers).*

- Press on the map with both fingers at the same time and keep them pressed.
- To rotate the map view, turn your fingers clockwise anticlockwise.

Saved data

The infotainment system saves certain data, for example, frequent routes and position data, to make the entry of the destination more agile and optimise the route guidance.

Delete saved data

- Press **Settings > Basic function settings > Delete** and then **OK**

⚠ WARNING

Select the settings, enter the destination and the modifications for navigation only with the vehicle at a standstill.

Note

- If a detour is passed during route guidance, navigation may recalculate the route.
- The quality of the navigation recommendations given by the Infotainment system depends on the navigation data available and any reported traffic congestions. »

- Navigation announcements are not emitted if the sound is muted in the infotainment system.

Navigation functions and symbols

Navigation

Navigation functions depend on the equipment and country.














Functions

- Entering destination and route calculation (offline and online*).
- Indication of two navigation maps at the same time (screen and instrument panel*).
- Update of online* maps.
- Predictive navigation.
- 3D urban maps.
- Online* traffic information
- Dynamic POIs (points of interest)






Symbols on the map

The buttons and indications depend on the settings and the current driving situation.







Symbols for traffic events and points of interest (POIs) are displayed on the map, for example, petrol stations, train stations or interesting stopovers, provided navigation has such data »» page 183.

-  Current position
-  Search for destinations.
-  Destinations along the route.
-  Final destination
-  Home address
-  Work address
-  Favourite destinations
-  Additional window with more options.
-  Additional window with route options.
-  Centre the map on the current position.
-  Change view: 2D oriented to the north, or 2D oriented to the direction of travel, or 3D to the direction of travel.
-  Information about the current route guidance.
-  Map scale.



Symbols in the additional window

- To open the additional window, press .
-  Repeat the last navigation announcement.
-  Volume of navigation announcements.
-  Map lighting in Automatic, Day or Night mode.
-  Offer new guidance routes.

Other symbols

-  Entering the detailed destination for an address.
-  Search for destinations.
-  Frequent destinations.
-  Last destinations.
-  Favourite destinations
-  Back






Symbols in the route details

-  Current position.
-  Destination of the current guidance.

POI symbols (points of interest)

POIs (points of interest) are shown on the map, provided the navigation has said data.

Click on the desired POI (point of interest) to start a route guidance »» page 181.

-  Petrol station.
-  Parking lot.
-  Tourist information offices.
-  Train station.
-  Restaurant.

Traffic information.

POIs (points of interest) are shown on the map, provided the navigation has said data »» page 183.

Click on a traffic event to open an additional window with further details »» page 183.

-  Slow traffic.
-  Traffic jam.
-  Accident.
-  Broken down vehicle.
-  Slippery surface (ice or snow).
-  Road closed to traffic.
-  Slippery road hazard.
-  Danger.
-  Road works.
-  Strong wind.
-  Reduced visibility.

Navigation data

The Infotainment system is equipped with a built-in navigation data memory. Depending on the country, the necessary navigation data may already be pre-installed.

To provide correct route guidance and make the most of the functions offered, the infotainment system should be updated on a regular basis.

Using obsolete data may lead to errors during navigation. Current routes cannot be traced or the route guidances will lead to mistaken destinations.

Ensure navigation data is updated at all times.

Online* updating of navigation data

The navigation data of the regions through which you travel frequently is automatically updated in the background if the Internet connection is established and the privacy settings are valid.

- With the ignition switched on, the navigation data is updated automatically.

Manual update of navigation data

Current navigation data for large regions, for example Western Europe, can be downloaded from www.seat.com and stored on USB data devices. Navigation through USB data devices is not possible.

- Download the navigation data to a USB data device.
- Turn on the ignition of the vehicle.
- Connect the USB data device to the infotainment system. Navigation data is automatically updated in the background.

The map version is displayed in **HOME > ⚙ > System information.**

⚠ WARNING

If you update the navigation data manually while driving, it may cause accidents with serious injuries.

- Update the navigation data only with the vehicle at a standstill.

Note

Automatic update of the navigation data is subject to the privacy settings. In "Incognito" mode, no update is carried out.

Start route guidance





Depending on the country and equipment, different functions are available to enter destinations.

The different functions for entering destinations are found in the navigation main menu.


Opening the Navigation main menu

- Press **HOME > 🏠**.

Select the destination and start navigation

1. Press .
2. Select the desired destination. You can choose from  **Frequent destinations**,  **Last destinations** and  **Favourite destinations.**



OR: press  and enter the address in the input screen.



OR: detailed address.

3. Press **Start**.

Frequent destinations

The destination synopsis uses recorded data to propose possible destinations.

Select the destination and start navigation



1. Press  and then .
2. Select the desired destination. The route guidance starts automatically.

Quick start: for a quick start, press and hold the desired destination for a few seconds.

Last destinations

Navigation saves the last destinations to make them available for a route guidance.


Select the destination and start navigation

1. Press  and then .
2. Press the desired destination.
3. Press **Start**.



Quick start: for a quick start, press and hold the desired destination for a few seconds.

Favourite destinations

Save up to 20 destinations as favourites.

To save a destination as a favourite press  in the split screen when entering the destination.

Select the destination and start navigation

1. Press  and then .
2. Press the desired destination.
3. Press **Start**.

Note

Enter the destination as accurately as possible. If you enter a destination incorrectly, the route guidance will not be able to start or it will guide you to an incorrect destination.

Start route guidance by selecting from the map



The navigation map includes active areas at many points that are suitable for entering the destination. To do this, press the desired position or place on the map. If there is map data at this point, you can start a route guidance.

Whether it is possible to enter the destination through the navigation map depends on the

state of the data and it is not possible for all positions.

To start "offroad navigation", press an empty area without position data.


Start navigation

- Press .
- Move the view on the map until the desired position can be selected. The navigation map can be used by means of additional finger movements  page 179.
- Press the desired destination on the map.
- Press **Route**.

Offroad navigation*

"Offroad navigation" calculates routes to selected destination points using unknown data. When a destination point is outside the known roads or position data, navigation finds the route to the next point of the known road and completes the path to the next destination point with a direct connection.


Start navigation

- Move the view on the map until the desired position can be selected. The navigation map can be used by means of additional finger movements  page 179.
- Press on any point on the map without position data.
- Press **Route**.

Start route guidance using contact details

Start route guidance with the saved address data of a contact. Contacts saved without address data cannot be used for route guidance.

Start navigation

- Press .
- Press on the contact you want.
- Press **Route**.

Note

If the address details of a contact are obsolete, the route guidance will nevertheless take you to the registered address. Check that the contact address is updated.

Traffic information

The infotainment system receives detailed traffic information automatically if the Internet connection is established. This information is shown with symbols and highlighting the road network in colour on the map.

Traffic incidents

Traffic incidents, for example, traffic jams or congested traffic, are shown on the navigation map using symbols.

With an active route guidance, traffic incidents that are on the current route are shown in the route details. Such traffic incidents can be avoided **» page 183**.

Hazard information

Hazard information is shown on the navigation map with symbols in the same way as traffic incidents. In this case, the source of this information is another vehicle that has detected the hazard and has uploaded the information to the service provider.

The following hazards are displayed: accident, broken down vehicle and slippery road surface.

Traffic flow indication

The navigation map shows traffic flow according to current traffic events, highlighting the road network in colour.

- **Orange:** Slow traffic.
- **Red:** Traffic jam.

Note

Traffic information receipt is subject to the privacy settings. In maximum Privacy mode, no traffic information is received. Tracking or Location level setting is necessary.



Function descriptions

Route details

The route details contain information on all incidents, for example, the starting point, stopovers, traffic events, POIs and destination, provided the navigation has such data.

If you press on an incident, an additional window opens providing more options. The available options depend on the incident and the current settings.

Open and close the route details

- To open, press  or swipe it.
- To close, press  or swipe it.

Edit route guidance

To edit route guidance, move the stopovers to the destination in the TripView view.

- Hold the desired destination pressed until it is visibly highlighted.
- Move the destination to the desired position.
- Remove your finger from the screen. The route will recalculate.

Avoid traffic incidents

The details of the route show the current traffic incidents if the navigation has such data. **»**

Avoid traffic incidents by editing route details
 »» page 183.

- Press on a traffic event.
- Press on **Avoid**. The route will recalculate.

Split screen

When handling navigation functions, an additional window with other options may open. Possible options depend on the function being used.

Close the additional screen

- Press on an empty area outside the additional window.
- **OR:** press **X**.
- **OR:** press **Accept**.

Functions in the additional window:

Show on map	Show what is selected on the map.
Add stopover	Add a stopover to the route guidance.
Direct route	Starts direct route guidance.

Functions in the additional window:

Delete	Delete a stopover from the route guidance.
Avoid	Avoid traffic jam. The route will recalculate.
Stopping route guidance	Ends the current route guidance.
X	Close the additional window.
☆	Add a destination to favourites.

Learn usage pattern

When the vehicle is in motion, navigation saves routes and destinations used to automatically generate destination proposals. Destinations are learned based on the time of day and the day of the week.

Navigation can propose up to 5 routes at the same time. The proposed routes may be different from the routes of the normal route guidance.

If one of the proposed destinations is selected, the guide to that destination is started.

The route guidance follows the selected route until the vehicle deviates from it. In that case, the route is recalculated and takes you back along the most direct path to the initially selected destination.

Important traffic jams are taken into account in the route guidance, and are avoided if alternative routes are available, provided navigation has such data.

You can activate and deactivate the function whenever you want.

Enable and disable learning usage pattern

The setting is in the corresponding navigation menu **⚙️ > Basic function settings**.

- To activate the function, activate **Learn usage pattern**.
- To disable the function, disable **Learn usage pattern**.
- To delete saved data, press **Delete usage pattern**.

Telephone interface

Introduction

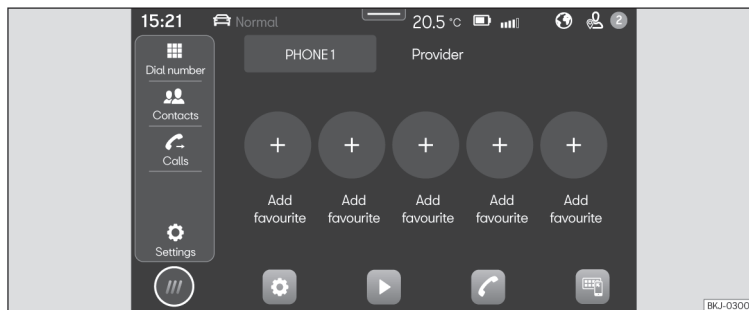


Fig. 133 Schematic representation: Phone view

You can use the telephone interface to connect your mobile to the infotainment system and operate phone functions through it. The sound is played through the vehicle's speakers.

You can connect up to two mobile phone devices simultaneously to the infotainment system.

High speeds, poor weather or road conditions and a noisy ambience (even outside of the vehicle), as well as the quality of reception can all affect the quality of a telephone conversation in the vehicle.

Note

- As a general rule, pairing a device (for example, a mobile phone device) is only necessary once. You can restore the device connection via Bluetooth® or Wi-Fi with the infotainment system whenever you want without having to pair the device again.
- The availability of some telephone functions will depend on the mobile phone connected to the infotainment system.

Telephone interface equipment and symbols

Equipment features

- Hands-free function.
- Use up to two phones at the same time.
- Phone book with a maximum of 5,000 contacts.
- SMS functions via Bluetooth®*: reading SMS, writing SMS (including templates), SMS playback, message history.
- Email functions via Bluetooth®*: reading email, writing email.



- Connection to wireless charging option.
- Connection to the microphone mounted on the vehicle.

Symbols in the main menu

- Contacts.
- List of incoming and outgoing calls.
- Enter telephone number.
- Text messages (SMS and emails).*
- Telephone interface settings.

Symbols for calls

The symbols may be different depending on the infotainment system.

- Start a call or bringing it to the foreground.
- End or reject a call.
- Open contact list.
- Enter telephone number.
- Mute the sound of the hands-free
- Hold call.
- Continue call.
- Start conference call.
- Pass call to private mode
- SOS** Make an emergency call.
- Get help in case of breakdown.

- i** Obtain information on the SEAT brand and selected additional services related to traffic and your travel.
- Voice mail.

Call list symbols

- To open the call lists, press .
- Incoming call.
- Outgoing call.
- Missed call.
- Telephone number (company).
- Telephone number (private).
- Mobile telephone number (company).
- Mobile telephone number (private).
- Fax (private).
- Fax.

Symbols for text messages*

The symbols may be different depending on the infotainment system.

- To open the text messages, press .
- Activate voice control input **>>>** page 169.
- Templates for text messages.

Places with special regulations

Switch off the mobile telephone and the telephone interface in places with a risk of explosion. These places are not always clearly marked. They include, for example:

- the vicinity of chemical pipelines and tanks
- The lower decks of boats and ferries.
- In the proximity of vehicles that run on liquefied gas (such as propane or butane).
- places where the air is laden with chemicals or particles such as flour, dust or metal powder.
- All other places where the vehicle engine or telephone must be switched off.

WARNING

Switch off the mobile phone in areas with a risk of explosion!

Note

In areas where special regulations apply or the use of mobile phones is forbidden, it must be switched off at all times. The radiation produced by the mobile phone when switched on may interfere with sensitive technical and medical equipment, possibly resulting in malfunction or damage to the equipment.

Pair, connect and manage

Requirement for pairing:

- Bluetooth® is activated on the mobile phone device.
- Bluetooth® is activated on the infotainment system.
- Depending on the mobile device, it will be necessary to have the Bluetooth® menu open or activate the **Visibility** option so that the device is visible from the infotainment system.

Pair a mobile phone device suitable for telephony with the infotainment system to use the telephone interface functions. On the first connection, the mobile phone device is paired with the infotainment system. Doing so saves a user profile » **page 187**.

The pairing can take a few minutes. The functions available depend on the mobile phone device used and its operating system.

Pair a mobile phone device

- Open the list of available Bluetooth® devices on the mobile phone device and select the name of the infotainment system.
- Please note and, if necessary, confirm the messages that appear on the mobile phone device and on the infotainment system. If the pairing was successful, the phone data is saved in the user profile.

- *Optional:* confirm the data transfer message on the mobile phone device.

Active and passive connection

To use the functions of the telephone interface, there must be at least one mobile phone device *connected* to the infotainment system. If there are several mobile phone devices connected to the infotainment system, you can switch between active and passive connections. To use the telephone interface with the desired mobile phone device, establish the active connection with the infotainment system.

Difference between connection types

Primary	The mobile phone device is paired and connected. The functions of the telephone interface are performed with the data of said mobile phone device.
Secondary	The mobile phone device is paired and connected. Calls can be managed but the phone book, messages or other functions will not be active.

Paired mobile phone devices are stored in the infotainment system, even if they are not currently connected.

Connect a mobile phone device

Requirement: the mobile phone device is paired with the infotainment system.

- Bluetooth® is activated on the mobile phone device.

Establish an active connection

Requirement: several mobile phone devices are connected to the infotainment system at the same time.

- Select the desired mobile phone device from the drop-down menu. All other mobile phone devices are automatically in the passive connection.

User profiles

For each of the paired mobile phone devices an individual user profile is automatically created. In the user profile, data from the mobile phone device is stored, for example, contact details or settings. A maximum of four user profiles can be saved in the infotainment system at the same time.

WARNING

If you perform the pairing while driving, it could cause an accident or injury.

- Perform pairing only with the vehicle at a standstill. »

Note

- In the pairing of some mobile phone devices, a PIN number is shown on the screen of the mobile phone device. Enter that number in the infotainment system to complete the pairing.
- While the infotainment system is in the **Known mobile phones menu**, the wireless charging function is disabled. When you exit this menu, the wireless charging function is activated again.

Basic and Comfort Telephony

Depending on the equipment, two types of telephone interface can be used:

- Basic telephone interface.
- Comfort telephone interface.

Basic telephone interface

The Basic telephone interface uses the Bluetooth® HFP profile for transmission. This interface allows the use of telephone functions through the infotainment system and playback through the vehicle's speakers.

Comfort telephone interface

Like the Basic telephone interface, the Comfort telephone interface also uses the Bluetooth® HFP profile.

The Comfort phone interface can be equipped with the wireless charging function » page 189.

In order to use the functions of the wireless charging function, you have to place a suitable mobile phone device correctly in the storage compartment. The mobile phone device will then connect to the vehicle antenna. This improves the reception and sound quality of calls.

To call

Open the telephone interface



- Press **HOME** > .

Make a call

Select a phone number to start a call. Different functions are available for selecting a phone number:

Contacts



If a contact has several registered phone numbers you have to select one.

- Press  and press a number on the list to start the call.
- **OR:** press  and enter the contact name in the input field to search for it. Press on the contact to start the call.

- **OR:** press a favourite in the telephone interface main menu to start the call.



Calls


The telephone interface shows the call list of the mobile telephone device. Start a call from the call list.

- Press  > **All** and press a number on the list to start the call.
- **OR:** press  and filter the call list entries (for example, missed calls or dialled numbers). In filtered list, press a number to start the call.

Dial

Manually enter a phone number to start a call. While entering the phone number, contacts that match that number are shown on the infotainment screen.

- Press  and enter the phone number.
- Press  to start the call

The last call is dialled by pressing and holding the  button on the multifunction steering wheel.

Send messages*

Depending on the mobile phone device and the infotainment system used, you can send

and receive SMS and e-mails through the telephone interface.

Send an SMS

- Press **✉ > Text message > Enter new message** and enter the message on the screen.
- Enter the contact you want in the search bar.
- To send the message press **OK**.

Send an e-mail

- Press **✉ > E-mail > Enter new message** and enter the message on the screen.
- Enter the contact you want in the search bar.
- To send the message press **OK**.

Phone book, favourites and speed dial buttons

In the first connection of a telephone with the infotainment system, the phone book is saved in the infotainment system. It may be necessary to confirm the data transmission on the mobile phone.

Each time the phone is reconnected, the phone book is updated.

If conference calls are supported, the phone book can be accessed during a call. If there is a saved image for a contact, it can be displayed in the list next to the entry.

Favourites


A speed dial button can be assigned to a maximum of 5 or 6 favourites from the phone book (depending on the equipment). If there is a registered photo saved to the contact, it is shown on the speed dial button.

All speed dial buttons have to be manually edited and will be assigned to a user profile.

Assign the speed dial button

- In the **Favourites** menu, press the **+** button, then open the phone book to select a contact as a favourite. If the contact has several phone numbers, press on the number in the list.

Edit the speed dial button

- To edit or delete a favourite contact press on the icon  in the **Favourites** menu screen. You can delete one or more favourites.

Call a favourite

- Press the assigned speed dial button.

Note

Favourites are not updated automatically. If you change a contact's phone number, you have to reassign the speed dial button.

Connectivity Box*



Fig.134 In the centre console: pad for the mobile phone connection.

The Connectivity Box includes the *Wireless Charger* functionality. »

(Wireless Charger)

The Wireless Charger allows mobile devices with Qi¹⁾ technology to be charged without a cable.

To charge your mobile phone wirelessly:

- Place your mobile device in the middle of the pad with the screen facing up »» Fig. 134 »» ⚠.

Make sure there are no objects between the pad and the mobile phone.

The mobile phone will start charging automatically. For further information about whether your mobile device uses Qi technology, check your phone's user manual or visit the SEAT website.

⚠ WARNING

- The mobile phone may heat up due to the wireless charging. Think about this before you pick it up, and take care when removing it.
- There must be no metallic or other objects between the mobile phone and the housing, to prevent the functionality of the Connectivity Box from being affected.

i Note

- Your mobile device must support the Qi inductive charging interface standard for proper operation.
- The charging time and the temperature vary in accordance with the device used.
- The maximum charging capacity is 5 W.
- Qi technology does not allow you to charge more than one mobile device simultaneously.
- You are advised to keep the engine running to guarantee proper wireless charging.
- When a telephone with Qi technology is connected by USB, it will be charged by the means specified by the manufacturer.

Multimedia

USB port



Fig. 135 Centre console: USB port.

Depending on the equipment and the country, the vehicle may have different types of USB connections.

The USB port can be found in the storage compartment area of the front centre console »» Fig. 135.

¹⁾ Qi technology allows you to charge your mobile phone wirelessly.

Driving

Start and driving

Starting and stopping the engine

Ignition lock

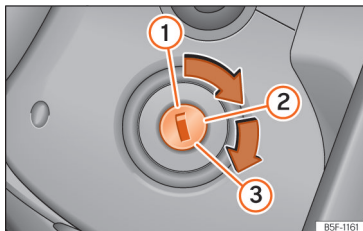


Fig. 136 Ignition key positions.

Key positions »» Fig. 136

- ① Ignition off. Key can be removed from the vehicle.
- ② Ignition is switched on. Preheating occurs in diesel vehicles ☹.
- ③ Starting the engine.

Locking and unlocking the steering wheel

- Lock the steering wheel: remove the key from the ignition and turn the wheel until it locks. Depending on the country, in vehicles with automatic transmission, in order to remove the key, move the gear shift to the **P** position. If necessary, press the gear shift blocking key and release it.
- Unlock the steering wheel: put the key into the ignition and turn it at the same time as the steering wheel in the direction indicated by the arrow. If it is not possible to turn the steering wheel, it may be because it is locked.

Start-Stop system*

If the vehicle is stopped and the Start-Stop system* switches off the engine, the ignition remains switched on.

Automatic transmission: before leaving the vehicle, make sure that the ignition is switched off and the selector lever is in position **P**.

⚠ WARNING

- Always remove the key from the ignition when leaving the vehicle, even if only for a short period. This is especially important if children or disabled people are left alone in the vehicle. They could accidentally start the engine or operate electrical equipment, resulting in an accident.
- The ignition key must NOT be removed from the lock until the vehicle comes to a

standstill. Otherwise, the steering could be immediately blocked- Risk of accident!

i Note

- If it is difficult to turn the ignition key to the position ②, move the steering wheel to both sides to release the steering lock.
- If the vehicle battery is disconnected and reconnected, the key must remain in the position ② for around 5 seconds before starting up.
- Vehicles with automatic transmission, depending on the country, after switching off the ignition, you can only remove the ignition key if the selector lever is in position "P" [parking lock]. Next, the selector lever is locked.

Ignition and start button*



Fig. 137 In the lower part of the centre console: start button.

The engine can be started with a start button (Press & Drive). To do so, there must be a valid key inside the vehicle in the area of the front or rear seats, or on the centre console.

In vehicles with the Keyless Access **>>> page 98** system, the engine can also be started with the key in the luggage compartment.


Opening the driver's door **when exiting the vehicle** activates the electronic lock on the steering column if the ignition is disabled.

Switching the ignition on/off manually

If you only want to switch on the ignition (without starting the engine), briefly press the start button once **without pressing** the brake pedal or the clutch pedal **>>> ⚠**.

The start button text (START ENGINE STOP) flashes like a heartbeat when the system is ready for the ignition to be turned on or off.

Automatic ignition disconnection


If the driver leaves the vehicle, taking the key with them but leaving the ignition on, the ignition does not switch off automatically. The ignition is switched off by pressing the lock button on the remote control  or by pressing the sensor surface on the door lever

>>> Fig. 88.

Automatic deactivation of the ignition on vehicles with the Start-Stop system

The ignition is switched off automatically when the vehicle is stopped and the automatic engine shutdown is active, if:

- The driver's seat belt is not fastened,
- the driver does not step on any pedal,
- the driver door is opened.

After automatically turning off the ignition, if the dipped beam  is on, the side light remains on for approx. 30 minutes (if there is enough charge in the battery). If the driver locks the vehicle or manually turns off the light, the side light goes out.

Engine restart feature

If no key is detected inside the vehicle after the engine stops, you will only have 5 sec-

onds to restart it. A warning will display on the dash panel screen.

After this interval, it will not be possible to start the engine without a valid key inside the vehicle.

⚠ WARNING

When switching on the ignition, do not press the brake or clutch pedal, otherwise the engine could start immediately.


⚠ WARNING

If vehicle keys are used negligently or without due care, this may cause accidents and serious injury.

- **Never leave any key inside the vehicle when you leave it. Otherwise, a child or unauthorised person could lock the vehicle, start the engine or connect the ignition and operate any of the electrical equipment.**

Note

- **Before leaving the vehicle, always disconnect the ignition and, if appropriate, take into account the instructions on the screen of the dash panel.**
- **If the vehicle is stationary for a long time with the engine off and the ignition on, the vehicle battery might be discharged and it might not be possible to start the engine.**


- In vehicles with diesel engines, wait until the warning light  » page 193 goes off before starting the engine.
- If during the STOP phase you press the **START ENGINE STOP** button, the ignition is switched off and the button flashes.
- If the indication is displayed on the instrument panel display “Start-Stop system deactivated: Start the engine manually”, the **START ENGINE STOP** button will blink.

Starting the engine

Before starting the engine

- *Vehicles with manual gearboxes:* put the gear lever in neutral, press the clutch pedal and keep it in this position until the engine starts.
- *Vehicles with automatic transmission:* put the lever in position **P** or **N**.

Vehicles with ignition locks


- Turn the key to position » **Fig. 136 ②**. Preheating occurs in diesel vehicles .
- Keep turning the key to position » **Fig. 136 ③** without stepping on the accelerator.
- Once the engine starts, release the key. When it is released, the key returns to position **②**.


- If the engine does not start, stop and wait for around 1 minute to try again.

Vehicles with start buttons

- Press and hold the brake pedal until the engine starts.
- Press the starter button » **Fig. 137**; do not press the accelerator. There needs to be a valid key inside the vehicle for the engine to start. After starting the engine, the lighting of the **START ENGINE STOP** button changes to steady lighting, indicating that the engine has started.
- Once the engine starts, release the start-up button.

- If the engine does not start, stop and wait for around 1 minute to try again. If necessary, perform an emergency start » **page 195**.

Diesel engines can take a few seconds longer than usual to start on cold days. During preheating, the warning lamp  remains lit. To avoid unnecessary discharging of the battery, do not use any other major electrical equipment while the glow plugs are preheating.

The preheating time depends on the coolant and exterior temperatures. With the engine at operating temperature, or at outside temperatures above +8°C, the warning lamp  will light up for about one second. This means that the engine starts *immediately*.

Starting a diesel engine after having run out of fuel

If the fuel tank has been completely run dry, it may take longer than normal (up to one minute) to start a diesel engine after refuelling. This is because the fuel system must eliminate air first.

WARNING

Do not keep the engine running in confined spaces, as there is a danger of poisoning.

- The exhaust gases contain carbon monoxide, an odourless and colourless poisonous gas that can cause loss of consciousness and death.

WARNING

Do not get out of the vehicle with the engine running, especially if a gear is engaged. The vehicle could then suddenly move or something strange could happen that would cause damage, fire or serious injury.

WARNING

Never use cold start sprays, they could explode or cause the engine to run at high revs. Doing this risks injury.

CAUTION

- The starter motor or the engine may be damaged if you try to start the engine while »

driving or if you restart it immediately after switching it off.

- When the engine is cold, you should avoid high engine speeds, driving at full throttle and over-loading the engine. Risk of engine damage.



For the sake of the environment

Do not warm-up the engine by running the engine with the vehicle stationary. Start off immediately, driving gently. This helps the engine reach operating temperature faster and reduces emissions.

Note


- Electrical components with a high power consumption are switched off temporarily when the engine starts.
- When starting with a cold engine, noise levels may briefly increase. This is quite normal, and no cause for concern.
- When the outside temperature is below +5 °C (+41 °F), if the engine is diesel, some smoke may appear under the vehicle when the fuel-operated auxiliary heater is on.
- In vehicles with a natural gas engine (CNG), by default, the engine starts with gas, with the exception of the following cases:
 - Coolant temperature below -15°C.
 - After refuelling CNG.

Turning off the engine

- Bring the vehicle to a full stop »» .
- With manual transmission, press the clutch all the way down. If the vehicle is automatic, set the selector lever to the P position.
- Apply the handbrake.
- *Vehicles with ignition locks:* Turn the key to position »» **Fig. 136** .
- *Vehicles with start buttons:* Briefly press the start-up button »» **Fig. 137**.

Emergency disconnection

If the engine does not switch off after briefly pressing the starter button, an emergency disconnect will be required:

- Press the starter button twice within 3 seconds or press it once for more than 1 second »»  in Ignition and start button* on page 192.

WARNING

Never switch off the engine while the vehicle is moving. This could cause loss of control of the vehicle, accidents and serious injury.

- The airbags and belt tensioners do not work when the ignition is switched off.
- The brake servo does not work with the engine off. Therefore, you need to press the brake pedal harder to brake the vehicle.

- Power steering does not work when the engine is not running. You need more strength to steer when the engine is switched off.
- If the ignition is switched off, the steering column could be locked, making it impossible to control the vehicle.
- Never remove the key from the ignition if the vehicle is in motion. Otherwise, the steering could suddenly lock, making it impossible to steer the vehicle: risk of accident!

WARNING

Always take the key with you when you leave the vehicle. This is particularly important if there are children in the vehicle, as they might otherwise be able to start the engine or use power-operated equipment (e.g. the electric windows), which could cause injuries.

CAUTION

- If the vehicle is stopped and the Start-Stop system* switches off the engine, the ignition remains switched on. Make sure that the ignition is switched off before leaving the vehicle, otherwise the battery could discharge.
- If the engine has been driven at high speed for a prolonged period of time, it may overheat when turned off. To avoid engine damage, allow the engine to run for

approximately two minutes in neutral before switching it off.

Note

After the engine is switched off the radiator fan may run on for up to 10 minutes, even if the ignition is switched off. It is also possible that the fan turns itself on once more if the coolant temperature increases due to the heat accumulated in the engine compartment or due to its prolonged exposure to solar radiation.

Electronic immobilizer

The electronic immobiliser prevents unauthorised persons from driving the vehicle.

Inside the key there is a chip that deactivates the electronic immobiliser automatically when the key is inserted into the ignition.

The electronic immobiliser will be activated again automatically as soon as you pull the key out of the ignition lock. For vehicles with the “Keyless Access” system, the key has to be outside the vehicle.

If the following message is shown on the instrument panel display: **SAFE**, the vehicle cannot be started.

The engine can only be started using a genuine SEAT key with its correct code.

Note

A perfect operation of the vehicle is ensured if genuine SEAT keys are used.

Emergency starting function



Fig. 138 On the right of the steering column: emergency start.

If no valid key is detected inside the vehicle, an emergency start-up will be required. The relevant message will appear in the dash panel display. This may happen when, for example, the vehicle key battery is very low:

- Immediately after pushing the starter button, keep the key next to the right trim of the steering column » **Fig. 138**, as close as possible to the Kessy logo.
- The ignition connects and the engine starts automatically.

“My Beat” function

For vehicles with a convenience key there is the “My Beat” function. This feature provides an additional indication of the vehicle ignition system.

When entering the vehicle, the start button » **Fig. 137** flashes to draw attention to it.

When the ignition is on/off, the engine start button flashes. With the ignition is switched off, the start button goes off after a few seconds.

With the engine running, the start button light stays on, indicating that the engine is running. The time elapsed between the moment the user starts the engine with the start button and the lighting changes from flashing to fixed will depend on specific engine size characteristics. When the start button is used to stop the engine, the button starts flashing again.

In vehicles **with the Start-Stop system**, the “My Beat” function also offers additional information:

- When the engine stops during the Stop phase, the light of the start button button stays on, as the Start-Stop system remains active even though the engine is off.
- When the engine cannot be started again with the Start-Stop system, » **page 196**, »

and needs to be started manually, the start button flashes to indicate this situation.

Start-Stop system*

Control lamps

It lights up

The Start-Stop system is available, the automatic engine shutdown is active.

It lights up

The Start-Stop system is not available or has been disconnected.

Instructions for the driver on the instrument panel display

Start-Stop system deactivated. Start the engine manually

This indication for the driver shows that the Start-Stop system **cannot** start the engine again.


Start-Stop system: Fault! Function not available

There is a fault in the Start-Stop system. Take the vehicle to a workshop to have the fault repaired.


Description and operation

The Start-Stop system helps you to save fuel and reduce CO₂ emissions.


In Start-Stop mode, the engine will automatically switch off when the vehicle stops or is stopping. The ignition remains switched on. The engine automatically switches back on when required.

In this scenario, the light of the  button stays lit¹⁾.

When the ignition is switched on, the Start-Stop function is automatically activated.

Further information about the Start-Stop system can be found in the Easy Connect system: press the button **CAR /  > View > Vehicle status**.


Vehicles with a manual gearbox

- When the vehicle or when it is stopped, put it into neutral and release the clutch pedal. The engine will switch off. The warning lamp  will light up. The engine can be stopped

before stopping completely (approximately 7 km/h).

- When the clutch pedal is pressed the engine will start up again. The warning lamp will switch off.

Vehicles with an automatic gearbox

- Brake until the vehicle stops and keep your foot on the brake pedal. The engine will switch off. The warning lamp  will appear in the display. The engine can be stopped before stopping completely (approximately 7 or 2 km/h depending on the vehicle's gearbox).

- When you take your foot off the brake pedal the engine will start up again. The warning lamp will switch off.

Basic requirements for the Start-Stop mode


- The driver door must be closed.
- The driver's seat belt must be fastened.
- The bonnet must be closed.
- The engine has reached operating temperature.
- The reverse gear must not be engaged.
- The vehicle must not be on a very steep slope.

¹⁾ Only in vehicles with Keyless Access.

The engine does not turn off for various reasons

Before stopping the vehicle, the system verifies whether certain conditions are met. The engine **does not** switch off, in the following situations for example:

- The engine has not yet reached the required temperature for the Start-Stop mode.
- The temperature selected on the climate control has not been reached.
- The interior temperature is very high/low.
- Defrost function button activated »» page 140.
- The parking aid* is switched on.
- The battery is very low.
- The steering wheel is overly turned or is being turned.
- If there is a danger of misting.
- After engaging reverse gear.
- In case of a very steep gradient.

 is shown on the instrument panel display, as well as on the driver information system*

START  STOP

The engine starts by itself

When stopped, the normal system mode may be interrupted in the following situations. The engine restarts by itself without involvement from the driver.

- The interior temperature differs from the temperature selected on the climate control.
- Defrost function button activated »» page 140.
- The brake has been pressed several times consecutively.
- The battery is too low.
- High power consumption.

Additional information related to the automatic gearbox

The engine stops when the selector lever is in the positions **P**, **D**, **N** and **S** in addition to when in Tiptronic mode. With the selector lever in **P**, the engine will also remain switched off when you take your foot off the brake pedal. In order to start the engine up again the accelerator must be pressed, or another gear engaged or the brake released.

If the selector lever is placed in **R** while stopped, the engine will start up again.

Change from **D** to **P** to prevent the engine from accidentally starting when passing through R.

Additional information about vehicles with Adaptive Cruise Control (ACC)

In vehicles with ACC function, the engine will start up again in certain operating conditions if the radar sensor detects that the vehicle ahead drives off again.

WARNING

- Never switch the engine off until the vehicle is stationary. The operation of the brake and steering will not be fully guaranteed. More force will be needed to turn the steering wheel or to brake. You could suffer an accident and even serious injuries.
- To avoid injury, make sure that the Start-Stop system is switched off when working in the engine compartment »» page 198.

CAUTION

The Start-Stop system must always be switched off when driving through flooded areas »» page 210.

Note

- In vehicles with an automatic gearbox, you can control whether the engine should switch off or not by reducing or increasing the brake force applied. While the vehicle remains stopped, the engine will not stop if the brake pedal is slightly pressed, in traffic jams with frequent stopping and starting for example. As soon as strong pressure is applied to the brake pedal, the engine will stop.
- When stopped, the brake pedal must be kept pressed to ensure that the vehicle does not move. »

- If the engine “stalls” with a manual gearbox, it can be directly started up again by immediately pressing the clutch pedal.
- With an automatic gearbox, if the lever is placed in position D, N or S after engaging reverse gear, 10 km/h (6 mph) in a forwards direction must be reached for the system to be in a status to stop the engine.

Manually connecting and disconnecting the Start-Stop system

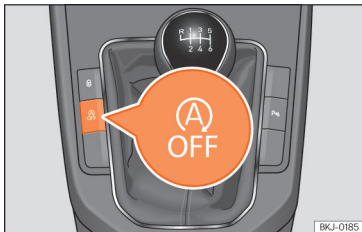




Fig. 139 Centre console: Start-stop system button.

If you do not wish to use the system, you can switch it off manually.

- To manually switch on/off the Start-Stop system, press the  button »» Fig. 139.

The button symbol  remains lit up yellow when the system is switched off.

Note

The system switches on every time the engine is turned off voluntarily.

Manual gearbox

Changing gears

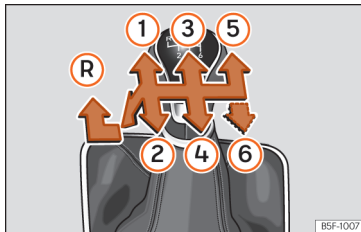



Fig. 140 Gear shift pattern of a 5 or 6-speed manual gearbox.

The position of the gears is indicated on the gearbox lever »» Fig. 140.



- Press the clutch pedal and keep your foot right down.
- Move the gearbox lever to the required position.
- Release the clutch.

Selecting reverse gear

Engage reverse gear only when the vehicle is stopped.

- Press the clutch pedal and keep your foot right down.
- With the gearbox lever in neutral, push it downwards, move it to the left as far as it will go and then forwards to select reverse »» Fig. 140 .
- Release the clutch.

Changing down gears

While driving, changing down a gear must always be done gradually, i.e. to the gear directly below and when the engine speed is not too high »» . Changing down while bypassing one or various gears at high speeds or at high engine speeds can damage the clutch and the gearbox, even if the clutch pedal remains depressed »» .

WARNING

When the engine is running, the vehicle will start to move as soon as a gear is engaged and the clutch released. This also happens if the electronic parking brake is switched on.

- Never engage reverse gear when the vehicle is moving.

⚠ WARNING

If the gear is changed down inappropriately by selecting a gear that is too low, you may lose control of the vehicle, causing an accident and serious injuries.

ⓘ CAUTION

When travelling at high speeds or at high engine speeds, selecting a gear that is too low can cause considerable damage to the clutch and the gearbox. This can also occur if the clutch pedal is pressed and held and it does not engage.

ⓘ CAUTION

To prevent damage and avoid premature wear, please observe the following:

- Do not rest your hand on the gear lever while driving. The pressure applied by your hand is transmitted to the gearbox selector fork.
- Do not leave your foot on the clutch pedal; although the pressure may seem insignificant, it can cause the premature wear of the clutch plate. Use the foot rest when you do not need to change gear.
- Always ensure that the vehicle is completely stopped before engaging the reverse gear.
- Always press the clutch to the floor when changing gears.

- Never hold the vehicle "on the clutch" on hills with the engine on.

Automatic gearbox/DSG automatic gearbox*

Introduction

Your vehicle is equipped with an electronically controlled manual gearbox. Torque between the engine and the gearbox is transmitted via two independent clutches. They replace the torque converter found on conventional automatic gearboxes and allow for smooth, uninterrupted acceleration of the vehicle.

The **Tiptronic** system allows the driver to change gears *manually* » page 201, **Changing gear in Tiptronic mode***.

Control lamps

Ⓢ It lights up green

The brake is not pressed.
To select a gear range, press the brake pedal.

Ⓢ Flashes green

The selector lever locking button is not engaged. The vehicle is prevented from moving forwards. Engage the selector lever lock.

Selector lever positions

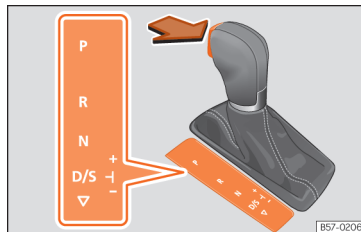


Fig. 141 Selector lever lock.


The selector lever position is shown when the corresponding sign lights up. With the selector lever in the manual gearbox positions **M**, **D** and **S**, the engaged gear is also shown on the display.

P – Parking lock

When the lever is put in this position, the drive wheels are locked. The lever must only be put in **P** when the vehicle is *stationary* » **⚠** »

To put the lever in **P** or take it out of **P**, the locking button must be pressed and held and the brake pedal pressed simultaneously.


R – Reverse gear

Reverse gear must be engaged only when the vehicle is *stationary* and the engine is idling »» » .

To move the lever to position **R**, the lock button must be pressed and held while pressing the brake pedal at the same time. The reverse lights come on when the lever is in the **R** position with the ignition on.

N – Neutral

With the lever in this position, the gear is in neutral.

Press the brake pedal to move the lever from **N** to **D/S** when the vehicle is stationary or at speeds below 3 km/h (2 mph) »» » .

D/S – Permanent forward drive position

The lever in the **D/S** position enables the gears to be operated in normal mode (**D**) or sport mode (**S**). To select Sport mode **S**, move the lever backwards. Pushing the lever again will select normal mode **D**. The selected driving mode is shown on the instrument panel display.

In **normal mode (D)**, the gearbox selects the best gear ratio. This depends on the engine

load, the road speed and the dynamic gear control programme (DCP).

Sport mode (S) should be selected for a sporty driving style. This setting makes use of the engine's maximum power output. When accelerating the gear shifts will be noticeable.

Under certain circumstances (e.g. on mountain roads) it can be advantageous to switch tiptronic mode »» » [page 201](#), to adapt the gears to suit the road conditions.

Selector lever lock

In **P** or **N**, the lever lock prevents a gear range from being engaged, and prevents the vehicle from moving off accidentally.

To release the gear lever lock, press and hold the brake pedal with the ignition on. At the same time, press the lever lock in the direction of the arrow »» » [Fig. 141](#).

As a reminder to the driver, when the lever is in positions **P** or **N** the following indication will be shown on the screen:

When stationary, apply footbrake while selecting a gear.

The lever is not locked if it is moved quickly through position **N** (e.g. when shifting from **R** to **D**). This makes it possible, for instance, to "rock the vehicle backwards and forwards" if it is stuck in snow or mud. The lever lock engages automatically if the brake pedal is not

pressed and the lever is in position **N** for more than about one second at a speed of less than 5 km/h (3 mph).

Safety interlock for ignition key

Once the ignition has been turned off, the key may be removed only if the gear selector is in position **P**. While the key is not in the ignition, the selector lever is locked in position **P**.

WARNING

- Take care not to press the accelerator pedal when the vehicle is stopped. The vehicle could start moving immediately (in some cases even if the parking brake is engaged) resulting in the risk of an accident.
- Never move the lever to R or P when driving. Failure to follow this instruction could result in an accident or failure.
- With lever in any position (except P), the foot brake must be pushed down whenever the engine is running. This is because an automatic gearbox still transmits power even at idling speed.
- While you are selecting a gear and the vehicle is stopped with the engine running, do not accelerate. Failure to follow this instruction could result in an accident.
- As a driver you should never leave your vehicle if the engine is running and a gear is engaged. Apply the parking brake and select the parking lock (P).

Note

- If the lever is moved accidentally to N when driving, release the accelerator and let the engine speed drop to idling before selecting gear range D or S again.
- Should the power supply to the lever be interrupted in position P, it will not be possible to move the lever. If this should happen the manual release can be used
»» page 205.

Note

- If the lever lock does not engage, there is a fault. The transmission is interrupted to prevent the vehicle from accidentally moving. Follow the procedure below in order for the lever lock to engage again:
 - With a 6-speed gearbox: press the brake pedal and release it again.
 - With a 7-speed gearbox: press the brake pedal. Move the lever to position P or N and subsequently engage a gear.
- Despite a gear being engaged, the vehicle does not move forwards or back. Proceed to the next mode:
 - When the vehicle does not move in the required direction, the system may not have the gear range correctly engaged. Press the brake pedal and engage the gear range again.

- If the vehicle still does not move in the required direction, there is a system malfunction. Seek specialist assistance and have the system checked.

Changing gear in Tiptronic mode*

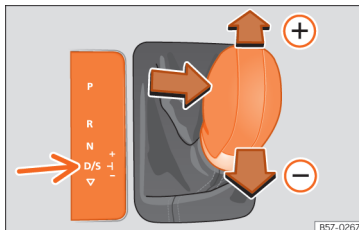


Fig. 142 Lever in the Tiptronic position

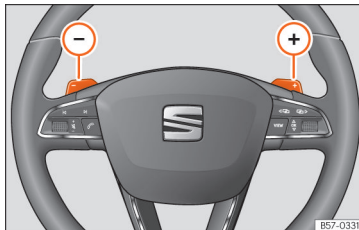


Fig. 143 Steering wheel: automatic transmission levers

Tiptronic gives the driver the option to change gears manually.

When you change to the Tiptronic programme, the vehicle remains in the currently selected gear. This is possible as long as the system is not changing gear automatically due to a traffic situation.

Using Tiptronic with the selector lever

It is possible to change to Tiptronic mode, both when the vehicle is stopped and while driving.

- Starting from the D/S position, move the lever to the right. The instrument panel will show whether the lever is in manual or Tiptronic mode (e.g. M4).
- Push the lever forwards (+) or backwards (-) to move up or down a gear »» Fig. 142.
- To exit Tiptronic mode, move the lever to the left.

Using Tiptronic with the steering wheel paddles*

The gearshift paddles can be used when the selector lever is in the D/S or M (Tiptronic) positions.

- Press the gearshift paddle (+) to select a higher gear »» Fig. 143.
- Press the gearshift paddle (-) to select a lower gear.

»

- To exit the Tiptronic mode, pull the right-hand lever towards the steering wheel for approximately 1 second or move the lever to the left.

If the paddles are not operated for some time and the lever is not in the Tiptronic selection position, it will automatically exit from Tiptronic mode.

ⓘ CAUTION

- **When accelerating, if a higher gear is not selected, it will automatically change shortly before reaching the maximum permitted RPM.**
- **Also, if a lower gear is selected, the system will not change until it detects that the engine will not reach its maximum RPM.**

Driving with an automatic gearbox

The gearbox changes gear ratios automatically as the vehicle moves.

The engine can only start with the selector lever in position **P** or **N**. At low temperatures, below -10 °C (+14 °F), the engine can only start with the selector lever in position **P**.

Driving down hills

Under certain circumstances it may be advantageous to use the Tiptronic mode to se-

lect the gear manually according to driving conditions »» ⚠.

Stop/Park

On level ground, just use the lever to engage position **P**. On slopes you should first apply the parking brake and then set the lever to **P**. This makes it easier to remove the lever from position **P** when starting.

If the driver door is opened and the lever is not in position **P**, the vehicle could move. The following warning is displayed on the instrument panel: ⚠ **Gear change: selector lever in the drive position!**. Additionally, a buzzer will sound.

Stopping on a downhill

Always press the brake pedal firmly to prevent the vehicle from moving; if necessary, apply the handbrake »» ⚠.

Do not accelerate while a range of gears is engaged to prevent the car from rolling downhill »» ⓘ.

Hill starts

- Apply the handbrake.
- Once you have engaged a gear press the accelerator carefully and disengage the handbrake.

Back-up programme

If all the positions of the lever are shown over a light background on the instrument panel display, there is a system fault and the automatic gearbox will operate in with the backup programme. It is still possible to drive the vehicle, however, at low speeds and within a selected range of gears. **Driving in reverse gear may not be possible.**

Kick-down

The kick-down system provides maximum acceleration when the gear selector lever is in the positions **D**, **S** or in the Tiptronic position.

When the accelerator pedal is pressed right down, the automatic gearbox will shift down to a lower gear, depending on road speed and engine speed. This takes advantage of the maximum acceleration of the vehicle »» ⚠.

The upshift to the next higher gear is delayed until the engine reaches maximum rpm.

⚠ WARNING

Observe the safety warnings »» ⚠ in Selector lever positions on page 200.


- **Never allow the brake to rub and do not use the brake pedal too often or for long periods, as the brakes can overheat. This reduces the braking power, increases the braking distance or even causes a brake system fault.**

- If you have to stop on a hill, keep the vehicle's brakes applied with the brake pedal or parking brake.

WARNING

Please note that if the road surface is slippery or wet, the kick-down feature could cause the driving wheels to spin, which could result in skidding.

CAUTION

- If you stop the vehicle on a gradient, do not attempt to stop it from rolling by depressing the accelerator when a gear has been selected. This could cause overheating and damage the automatic gearbox.
- If you allow the vehicle to roll with the lever in position N and the engine off, the automatic gearbox will be damaged by lack of lubrication.
- In certain driving situations or traffic conditions, the gears could overheat and be damaged! If the warning lamp  lights up, stop the vehicle as soon as you can and wait for the gearbox to cool »» page 204.
- If the gearbox operates with the backup programme, take the vehicle to a specialised workshop and have the fault repaired without delay.

downhill assistant*

Downhill speed control is activated when the lever is in the **D/S** position and the brake is applied. An appropriate lower gear is engaged.

The assistant attempts to maintain the speed at which the vehicle was travelling when the brake was applied, within logical limits. It may be necessary to correct the speed by pressing the brake.

The assistant can only change down as far as 3rd gear. It is possible that on very steep slopes you have to switch to tiptronic mode and change down to 2nd or 1st gear to take advantage of engine braking and take the load off the brake system.

Downhill speed control is deactivated as soon as the road levels out again or you press the accelerator pedal.

On vehicles with cruise control system* »» page 213, downhill speed control is activated when you set a cruising speed.

WARNING

The downhill speed control cannot defy the laws of physics. Therefore, speed cannot be maintained constant in all situations. Always be prepared to use the brakes!


Inertia mode

The inertia mode allows you to travel certain distances without using the accelerator, which saves fuel. Plan ahead and use the inertia mode to "let" the vehicle "roll".

Activation of the inertia mode

Condition: lever in position **D**, slopes of less than 12% and speeds between 20 and 130 km / h (12 and 80 mph).

- Gently take your foot off the accelerator.

The indication will be shown on the instrument panel , the engaged gear and current consumption will disappear and the word **Inertia** will appear.

The gears will automatically disengage and the vehicle will roll freely, without the effect of the engine brake. While the vehicle rolls, the engine runs at idling speed.

Stopping inertia mode

- Press the brake or the accelerator pedal.

To take advantage of the engine's inertia mode, simply remove your foot from the accelerator.

Applying both the **inertia mode** (= prolonged section with less energy) and **inertia disconnection** (= shorter section without the need »

for fuel) facilitates improved fuel consumption and emission balance.

If the vehicle has **SEAT Drive Profile**

»» page 207, the inertia mode can be activated in the **Normal**, **Eco** and **Individual** profiles. In the **Eco** profile, it is activated whenever the operating conditions are met, regardless of how smoothly you remove your foot from the accelerator.

WARNING

- If the inertia mode has been switched on, take into account, when approaching an obstacle, that the vehicle will not decelerate in the usual manner: risk of accident!
- When using inertia mode while travelling down hills, the vehicle can increase speed: risk of accident!
- If other users drive your vehicle, warn them about inertia mode.

Note

- The driver message **Inertia** is only displayed with the current consumption. In inertia mode the gear will no longer be displayed (for example "D" or "E" will appear instead of "D7" or "E7").
- The inertia mode will be automatically disconnected on gradients steeper than 15%.

- In the case of the 1.6l TDI engine, the inertia mode will only work with the Eco driving profile.


Indications on the instrument panel display

Clutch


-  **Clutch overheating! Please stop!**

The clutch has overheated and could be damaged. Stop and wait for the gearbox to cool with the engine at idling speed and the selector lever in position **P**. When the warning lamp and the driver message switch off, have the fault corrected by a specialised workshop without delay. If they do not turn off, do not continue driving. Seek specialist assistance.


Faults in the gearbox

-  **Gearbox: Fault! Stop the vehicle and place the lever in the position P.**


There is a fault in the gearbox. Stop the vehicle in a safe place and do not continue driving. Seek specialist assistance.

-  **Gearbox: System fault! You may continue driving.**


Have the fault corrected by a specialised workshop without delay.

-  **Gearbox: System fault! You can continue driving with restrictions. Reverse gear disabled**


Take the vehicle to a specialised workshop and have the fault repaired.

-  **Gearbox: System fault! You can continue driving in D until switching off the engine**

Park the vehicle in a safe place. Seek specialist assistance.

-  **Gearbox: too hot. Adapt your driving accordingly**

Continue driving at moderate speeds. When the warning lamp switches off, you can continue driving in a normal manner.

-  **Gearbox: press the brake and engage a gear again.**

If the warning was caused by the temperature of the gearbox, this driver message will be displayed when the gearbox has cooled again.

Manual release of the selector lever

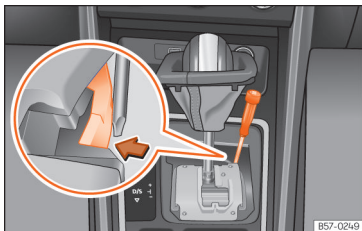


Fig. 144 Gear selector lever: manual release from the parking position.

In the event of a power failure when starting (e.g. discharged battery), the lever will remain locked in position **P**. To move it to position **N** to move the vehicle, there is an emergency release device under the centre console, on the right side. Releasing the selector lever requires a certain degree of practical skill.

Removing the cover from the selector lever

- Apply the handbrake firmly (P) » » ⚠.
- Carefully pull the corners of the selector lever boot and twist it upwards over the lever handle.

Releasing the selector lever

- Using the flat part of a screwdriver, press the yellow tab sideways and keep it pressed down » » Fig. 144.
- Press the lock button on the selector lever and move it to position **N**.
- After completing the emergency release, reattach the selector lever boot to the gearbox console.

⚠ WARNING

Do not move the lever from position P if the parking brake is not firmly engaged. If you still think the car could move, press the brake pedal. Danger! The vehicle could move in an unforeseen way and cause an accident or serious injury.

Gear-change recommendation

Selecting the optimal gear

Depending on the equipment on the instrument panel screen, a recommendation is shown with the gear that should be engaged to optimise consumption.

On vehicles with *automatic transmission*, the lever must be in Tiptronic mode » » page 201.

No recommendation will appear if the optimal gear is engaged. The current gear will be displayed.

Display	Meaning
3	Optimum gear.
4 ▶ 5	Changing to a higher gear is recommended.
2 ▶ 1	Changing to a lower gear is recommended.

Information regarding the “cleanliness” of the particulate filter

When the exhaust system detects that the particulate filter is close to saturation, this system’s self-cleaning function recommends the optimal gear for that function » » page 263.

⚠ WARNING

The gear change recommendation is an auxiliary function and in no case should be a substitute for careful driving.

- **Responsibility for selecting the correct gear, depending on the circumstances, rests solely with the driver.**

🌱 For the sake of the environment

Selecting the correct gear can help to save fuel. »

Note

The recommended gear indication turns off when the clutch pedal is pressed or when the lever is removed from the tiptronic position.


Steering

Information relating to different vehicle processes.

Electro-mechanical power steering adapts *electronically* to the speed of the car, torque and steering angle.

Even if the power steering fails or the engine is stopped, it is possible to continue to rotate the steering wheel as long as the key remains in the ignition lock, but more force must be applied.

Steering assist

This help assists the driver in critical situations. It recommends turning the steering wheel to perform a corrective manoeuvre (counter-steering), turning slightly to avoid skidding »» .

WARNING

Steering assist helps the driver in critical situations. The driver is the person who has to control the vehicle's steering at all times.

Control lamp

It lights up red

Faulty steering.

Do not continue driving, stop the vehicle as soon as possible and in a safe manner. Take the vehicle to a specialised workshop and have the fault repaired as soon as possible.

It lights up yellow

Limited steering operation.

Drive carefully to a specialised workshop to have the steering checked. If the warning light does not come on again after re-starting the engine and driving a short distance, it is **not** necessary to check the steering.

OR: The 12-volt battery was disconnected and re-connected. Drive a short distance at 15-20 km / h (9-12 mph).

It flashes yellow

The steering column is jammed. When stopped, turn the steering wheel in both directions.

OR: The steering column does not unlock or lock. Remove the key from the ignition switch and reconnect it. Consider the messages shown on the instrument panel display.

Do not continue driving if the steering column remains locked after switching on the ignition. Seek specialist assistance.

The control lamp should light up for a few seconds when the ignition is switched on. It should go out once the engine is started.

WARNING

Never ignore the warning lamps or messages.

- **If the warning lamps and the corresponding messages are ignored, the vehicle may stall in traffic, causing serious damage or accidents and injuries.**
- **Stop the vehicle at the next opportunity and in a safe place.**

SEAT Drive Profiles*

Introduction

The SEAT Drive Profile enables the driver to choose between the **Eco**, **Normal**, **Sport** and **Individual** profiles, which modify the behaviour of several vehicle functions, providing different driving experiences.

The **Individual** profile can be configured according to personal preferences. The other profiles have a fixed configuration.

Description

Depending on the equipment fitted in the vehicle, SEAT Drive Profile can operate on the following functions:

Engine

Depending on the profile selected, the engine responds more quickly or smoothly to the accelerator being pressed. When the **Eco** profile is selected, the Start-stop function is activated.

In vehicles with automatic transmission, the gear change timing is changed to put the changes at higher or lower revolutions. The **Eco** profile activates the Inertia function, thereby reducing consumption. The rest of the driving profiles will activate the inertia use

function when the selector lever is not in the **S** position, depending on how the accelerator pedal is released »» page 203. When the vehicle is turned on again, the function is activated by default to reduce consumption.

With manual transmission, the **Eco** profile changes the gear change recommendations to facilitate more efficient driving.

“Dual Ride” suspension*

The “Dual Ride” suspension sets the suspension to comfortable in the **Eco** and **Normal** profiles, and to sport in the **Sport** profile. In the **Individual** profile the suspension can be switched between **Normal** or **Sport**, depending on personal preference.

In the event of a fault in the “Dual Ride” suspension, the following message is displayed on the instrument panel screen **Fault: shock absorber regulation**.

Steering

Power steering becomes harder in the **Sport** profile to enable a sportier driving style.

Air conditioning

In vehicles with Climatronic, this can operate in the **Eco** profile, especially restricting fuel consumption.

Adaptive Cruise Control (ACC)*

The ACC’s acceleration and braking mode varies according to the driving profile »» page 222.

Setting the driving profile

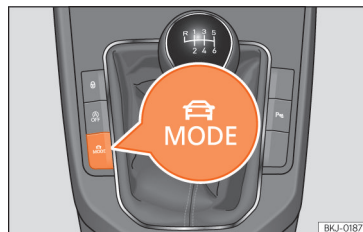



Fig. 145 Next to the gear lever: MODE button.

You can select from **Normal**, **Sport**, **Eco** and **Individual**.

You can select the required profile either by repeatedly pressing the selection button »» Fig. 145, or by using the touch screen, in the menu that opens when the aforementioned button is pressed.

An icon on the touch screen provides information about the active profile.

The illumination of the button  lights up when the active profile is anything other than **Normal**. »

Driving profile	Characteristics
ECO	Places the vehicle in a low state of consumption, facilitating a fuel-saving driving style that is respectful to the environment.
/i\ Normal	Offers a balanced driving experience, suitable for everyday use.
S Sport	Provides a complete dynamic performance in the vehicle, enabling the user a more sporty driving style.
Individual	It allows you to personalise the configuration. The functions that can be adjusted depend on the equipment fitted in the vehicle.

Kick-down*

The kick-down feature allows maximum acceleration »» page 202.

If the **Eco** profile has been selected in the SEAT Drive Profile*, and the accelerator is pressed beyond a hard point, the engine power is automatically controlled to give your vehicle maximum acceleration.

WARNING

When operating SEAT Drive Profile, pay attention to all traffic: doing otherwise could cause an accident.

Note

- When the engine is switched off it will store the driving profile that was selected when the ignition was turned off. When restarted, the engine and the gearbox will start in their Normal mode. To return the engine and gear to your desired mode, reselect the corresponding driving profile.
- Your speed and driving style must always be adjusted to visibility, weather, and traffic conditions.
- The Eco profile is not recommended when towing a vehicle.

Driving tips

Running in

Please observe the instructions for running-in new components.

Running-in the engine

A new engine must be driven through a run-in period during its first 1500 kilometres (1000 miles). During its first few hours of running, the internal friction in the engine is greater than later on when all the moving parts have bedded down.

How the vehicle is driven for the first 1500 km (1000 miles) influences the future engine per-

formance. Throughout the life of the vehicle, it should be driven at a moderate speed (especially when the engine is cold) this will reduce engine wear and increase its useful life. Never drive at extremely low engine speeds. Always engage a lower gear when the engine works "irregularly". **For the first 1000 km or 600 miles, please note:**

- Do not use full throttle.
- Do not force the engine above two thirds of its maximum speed.
- Do not tow a trailer.

Between 1000 and 1500 kilometres (600 to 1000 miles), gradually increase power until reaching the maximum speed and high engine speeds.

Running in new tyres and brake pads

- Replacement of wheel rims and new tyres »» page 277.
- Information about brakes »» page 228.

For the sake of the environment

If the engine is run in gently, the life of the engine will be increased and the engine oil consumption reduced.

Economical and environmentally friendly driving

Fuel consumption, environmental pollution and wear to the engine, brakes and tyres all depend largely on driving style. Consumption can be reduced between 10-15% with an efficient driving type. The following section gives you some tips on lessening the impact on the environment and reducing your operating costs at the same time.

Active cylinder management (ACT®)*

Depending on vehicle equipment, the active cylinder management (ACT®) may deactivate some of the engine cylinders if the driving situation does not require too much power.

Foresight when driving

If you think ahead when driving, you will need to brake less and thus accelerate less. Take advantage of the inertia of the vehicle whenever possible, with a **gear engaged**. This takes advantage of the engine braking effect, reducing wear on the brakes and tyres. Emissions and fuel consumption will drop to zero.

Changing gear to save energy

An effective way of saving is to change *in advance* to a higher gear.

Manual transmission: shift up from first to second gear as soon as possible. Choosing the right gear enables fuel savings. Select the highest possible gear appropriate for the driving situation (the engine should continue functioning with cyclical regularity).

Automatic transmission: accelerate gradually and without reaching the “kick-down” position.

Avoid driving at high speed

Avoid travelling at your vehicle’s top speed, whenever possible. Fuel consumption, emission of harmful gases and noise pollution multiply as speed is increased. Driving at moderate speeds will help to save fuel.

Reduce idling time

In vehicles with the Start-Stop system idling is automatically reduced. In vehicles without the Start-Stop system it is worth switching off the engine, for example, at level crossings and at traffic lights that remain red for long periods of time. When an engine has reached operating temperature, and depending on the cylinder capacity, keeping it switched off for a minimum of about 5 seconds already saves more than the amount of fuel necessary for restarting.

The engine takes a long time to warm up when it is idling. Mechanical wear and pollutant emissions are also especially high during

this initial warm-up phase. It is therefore best to drive off immediately after starting the engine. Avoid running the engine at high speed.

Regular maintenance

Regular servicing helps in saving fuel even before the engine is started. A well-serviced engine gives you the benefit of **improved fuel efficiency** as well as maximum reliability and an enhanced resale value. A badly serviced engine can consume up to 10% more fuel than necessary.

Avoid short journeys

The engine and catalytic converter need to reach their optimal **operating temperature** in order to minimise fuel consumption and emissions.

A cold engine consumes a disproportionate amount of fuel. The engine reaches its working temperature after about four kilometres (2.5 miles), when fuel consumption will return to a normal level.

Check tyre pressure

Always make sure the tyres are inflated to the correct pressures »» page 278 to save fuel. If the pressure is below half bar, fuel consumption may increase by 5%. Due to the greater rolling resistance, under-inflation **also** increases tyre wear and impairs handling. »

Do not use **winter tyres** all year round as they increase fuel consumption by up to 10%.

Avoid carrying unnecessary loads

Given that every kilo of extra **weight** will increase the fuel consumption, it is advisable make sure that no unnecessary loads are being transported.

Since the luggage rack increases the **aerodynamic drag** of the vehicle, you should remove it when not needed. At speeds of 100-120 km/h (62-75 mph), this will save 12% of fuel.

Save electrical energy

The engine drives the alternator, thereby generating electricity. This implies that any increase in power consumption also increases fuel consumption! For this reason, switch off any unneeded electrical devices. Devices that use a lot of electricity includes the blower at a high setting, the rear window heating or the seat heating*.

Note

- If you have the Start-Stop system, it is recommended that it should not be disconnected.
- It is recommended that you close the windows when driving at more than 60 km/h [37 mph].

- Do not drive with your foot resting on the clutch pedal, as the pressure can make the plate slip. This causes wear and can damage the clutch plate.

- Do not ride the clutch on a hill, use the brake. The fuel consumption will be lower and you will prevent the clutch plate from being damaged.

- Use the engine brake on downhill by changing to the gear that is best suited for the gradient. Fuel consumption will be "zero" and the brakes will not suffer.

Driving on flooded roads

To prevent damage to the vehicle driving on flooded roads, take the following into account:

- The water should never come above the lower edge of the bodywork.
- Drive at pedestrian speed.

WARNING

After driving through flooded zones, braking effectiveness can decrease if the brake discs or pads are damp »» page 228.

CAUTION

- Driving through flooded areas may damage vehicle components such as the engine, transmission or electrical system.
- Whenever driving through water, the Start-Stop system* must be switched off »» page 196.

Note

- Check the depth of the water before entering the flooded zone.
- Do not stop in the water, drive in reverse, or stop the engine.
- Vehicles travelling in the opposite direction cause waves that could exceed your vehicle's critical height.
- Avoid driving through salt water (corrosion) »» page 289.

Trips abroad

- With petrol vehicles, it should be ensured that lead-free petrol is available throughout the journey »» page 257, Fuel types. Seek information about service station networks selling unleaded fuel.
- In some countries, it is possible that your vehicle is not sold and some spare parts may not be available or the technical services may only be able to make limited repairs.

SEAT importers and distributors will provide information about the technical preparation that your vehicle requires and also about necessary maintenance and repair possibilities.

ⓘ CAUTION

SEAT does not accept liability for any damage to the vehicle due to the use of a lower quality fuel, an inadequate service or the non-availability of genuine spare parts.

Driver assistance systems

General notes

Safety advice

⚠ WARNING

- Responsibility for driving rests with the driver at all times. The drive assist systems are not a replacement for driver attention. Focus all your attention on driving and be prepared to intervene at all times.
- Use the drive assist systems only when conditions allow. The driving style must always be suitable for the weather, visibility, road and traffic conditions.
- In order for drive assist systems to react correctly, sensors and cameras must operate without limitations. Please read the notes on sensors and cameras in this chapter.

ⓘ Note

- Keep in mind the specific rules of each country, especially when it comes to driving, formation of an emergency corridor, braking distance, speed, parking position, wheel position, etc. The driver is solely responsible for always complying with the specific regulations of each country.
- The area in front of and around the radar sensor should not be covered with adhe-

sives, additional headlights or similar items, as this could have a negative impact on the operation of the assistants. If the vehicle is not properly repaired or structural modifications are made to it, the operation of the assistants may be affected.

- The repair and adjustment of sensors and cameras requires special knowledge and tools. It is recommended to visit a SEAT dealership for this purpose.

System limits

⚠ WARNING

- Drive assist systems can not overcome the laws of physics. Depending on the circumstances, a collision may not be avoidable.
- Warnings, notices and indicator lamps may not be displayed on time, or may be displayed incorrectly, e.g. if a vehicle approaches too quickly.
- Corrective interventions by drive assist systems (e.g. interventions in the steering or brakes) may be insufficient or may never occur, depending on the circumstances. As a driver, you must be prepared to act at all times.

»

Note

- Due to the system's detection limits in the surroundings, the systems may not give warnings or intervene on time, or they might do so even if it is not desired. In addition, the auxiliary systems may incorrectly interpret a manoeuvre and, as a result, warn the driver in an unexpected manner.
- When the towing mode is selected, some assist systems may react with limitations, in an unusual way or may not be available. Keep in mind the instructions relating to the towing mode.

Drive assist sensors and cameras

Front radar

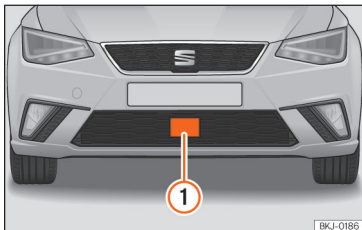


Fig. 146 On the front bumper: radar sensors.

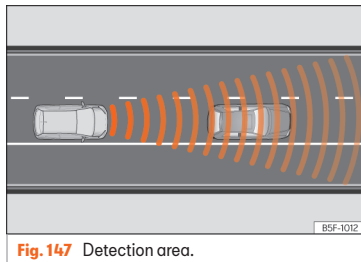


Fig. 147 Detection area.

A radar sensor may be fitted to the front bumper of the vehicle »» **Fig. 146**. The front radar detects any objects in its detection zone »» **Fig. 147** and provides support for the following functions:

- Front Assist »» page 219.
- Adaptive Cruise Control (ACC) »» page 222.

The radar can have a range of up to 120m (400ft) depending on road and weather conditions.

WARNING

The visibility of the radar sensor can be impaired by dirt or environmental influences such as rain, fog, snow, mud, dust, insects etc. In this case the Front Assist and ACC functions may stop working. The instrument panel displays the following message: No sensor vision! And the Front Assist un-

available or ACC unavailable warning lights come on.

- Clean the sensor area on the bumper as indicated in »» page 291, Cleaning the exterior. When the radar sensor starts correctly detecting again, the message disappears from the screen and the functions become available again.

CAUTION

- If the radar sensor is dirty or poorly adjusted, the Front Assist system may give unnecessary warnings and apply the brakes inappropriately.
- The operation of the radar can be affected by strong reflections of the emitted signal. This may occur, for example, in an enclosed car park or due to the presence of metallic objects (e.g. guard rails or sheets used in road works).
- The sensor may not be adjusted correctly if it receives an impact. This may compromise the system's efficacy or disconnect it. If you have the feeling that the radar sensor is damaged or adjusted incorrectly, switch off the Front Assist and ACC functions to avoid any damage. If this occurs have it adjusted.

Ultrasound sensors

The bumpers are fitted with ultrasound sensors to perform the following functions:

- Parking aid Plus »» page 236.
- Rear parking aid »» page 238.

ⓘ CAUTION

- Damage to the radiator grille, bumper, wheel arch and vehicle underbody can modify the orientation of the sensors. This can affect the parking aid function. Have the function checked by a specialised workshop.
- A number plate or number plate holder with dimensions that exceed the space for the number plate, or a cured or deformed number plate can cause false detections or a loss of visibility for the sensors.

ⓘ Note

- In order to guarantee good operation, keep the sensors clean, free of snow and ice, and do not cover them with stickers or other objects.
- If you use high-pressure or vapour equipment for cleaning, do not apply it directly, unless you do so very briefly, and always keep a distance of more than 10 cm away.
- Fitting certain accessories to the front of the vehicle, such as a plate holder with ad-

vertising, may interfere with the operation of the Park Assist.

Rear View Camera

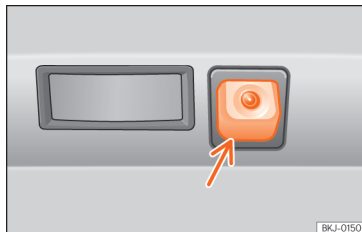


Fig. 148 In the rear bumper: location of the reverse assist camera.

A camera on the rear bumper aids the driver when reverse parking or manoeuvring. This provides support to the following function:

- Rear View Camera »» page 239.

⚠ WARNING

Fitting a number plate frame may interfere with the view shown on the screen, as it may reduce the camera's field of vision.

ⓘ CAUTION

- In order to guarantee good system operation, keep the cameras clean, free of snow

or ice, and do not cover them with stickers or other objects.

- Never use abrasive cleaning products to clean the camera lens.
- Do not use hot or warm water to remove ice or snow from the camera lens. Doing so could damage the camera.

Cruise control system (CCS)*

Control lamp

🕒 It lights up green

The Cruise Control System (GRA) is switched on and active.

OR: The Adaptive Cruise Control system (CCS) is switched on and active.

OR: the speed limiter is switched on and active.

The control lamps light up when the ignition is switched on and should turn off after approximately 2 seconds. This is the time taken for the function check.

⚠ WARNING

Observe the safety warnings »» ⚠ in Control and warning lamps on page 85.

Introduction

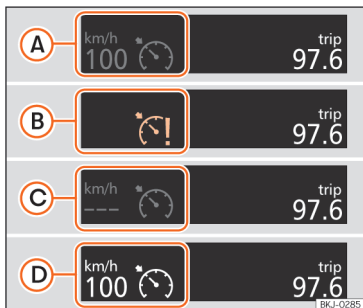


Fig. 149 Instrument panel display: GRA status indications.

The cruise control system (CCS) is able to maintain the set speed from 20 km/h (15 mph).

The CSS only reduces vehicle speed by ceasing to accelerate, not by actively braking the vehicle » .

Depending on the equipment, the cruise control can be operated using the lever of the turn signals » **page 215** or by the third lever » **page 215**.

Status display

GRA status » **Fig. 149**

- A** CCS temporarily switched off. The set speed is displayed in small or darkened figures.
- B** System error. Contact a specialised workshop.
- C** CCS switched on. The speed memory is empty.
- D** The CCS is switched on. The set speed is displayed in large figures.

Changing gear in CCS mode

The CCS decelerates as soon as the clutch pedal is pressed, intervening again automatically after a gear is engaged.

Travelling down hills with the CCS

If the CCS cannot maintain a constant vehicle speed downhill, brake and change down a gear if necessary. The GRA is temporarily disabled by pressing the brake.

Automatic off

The GRA disconnects automatically or is temporarily interrupted:

- If the system detects a fault that could affect the working order of the CCS.
- If you press and maintain the accelerator pedal for a certain time, driving faster than the stored speed.
- If the dynamic driving control systems intervene, ASR, ESC, etc.

- If the brake pedal is pressed.
- If the airbag is triggered.
- If the lever is taken out of the **D/S** position.

WARNING

Use of GRA could cause accidents and severe injuries if it is not possible to drive at a constant speed maintaining the safety distance.

- Do not use GRA in heavy traffic, if the distance from the vehicle in front is insufficient, on steep roads, with several bends or in slippery circumstances or on flooded roads.
- Never use the CCS when driving off-road or on unpaved roads.
- Adapt your speed and the distance to the vehicles ahead in line with visibility, weather, the condition of the road and the traffic situation.
- To avoid unexpected operation of the cruise control system, turn it off every time you finish using it.
- It is dangerous to use a set speed which is too high for other conditions.
- If driving down a steep gradient, the GRA cannot maintain a constant speed. The speed can increase. In this case, brake and change down a gear.

Operating the cruise control with the turn signal lever

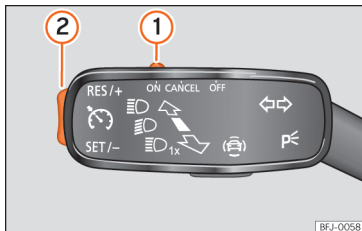


Fig. 150 On the turn signal lever: controls for operating the GRA.

Connecting

- Move the control »» Fig. 150 ① to **ON**.

If no speed has been programmed, the system will not control it.

Activating the cruise control

- Press button »» Fig. 150 ② in area **SET/-**.

The current speed is stored and the cruise control is activated.

Temporarily interrupting

- Move the control »» Fig. 150 ① to **CANCEL** or step on the brake.

The cruise control system is switched off temporarily. The speed is stored.

Reinstating the cruise control

- Press button »» Fig. 150 ② in area **RES/+**.

Cruise control is activated at the stored speed.

Adjusting the speed

While the GRA is set, the stored speed can be adjusted with button »» Fig. 150 ②:

- To increase in increments of 1 km/h [1 mph] briefly press button »» Fig. 150 ② in the area **RES/+**.
- To increase the speed without interruption, keep button »» Fig. 150 ② pressed down in the area **RES/+**.
- To reduce in increments of 1 km/h [1 mph] briefly press button »» Fig. 150 ② in the area **SET/-**.
- To reduce the speed without interruption, keep button »» Fig. 150 ② pressed down in the area **SET/-**.

The vehicle adapts the current speed by accelerating or stopping accelerating. The vehicle does not brake actively.

Switching off

- Move control »» Fig. 150 ① to **OFF**.

The system is disconnected and the memorised speed is deleted.

Operating the cruise control with the third lever

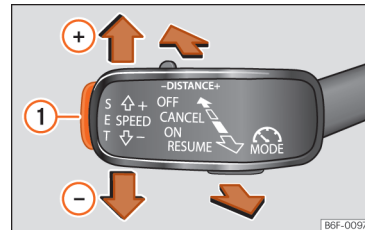


Fig. 151 On the left of the steering column: third lever for operating the GRA.

Connecting

- Move the lever towards the steering wheel to position **ON**.

If no speed has been programmed, the system will not control it.

Activating the cruise control

- Push button **SET** »» Fig. 151 ①.

The current speed is stored and the cruise control is activated.

»

Temporarily interrupting

- Move the lever to **CANCEL** and release it, or step on the brake.

The cruise control system is switched off temporarily. The speed is stored.





Reinstating the cruise control



- Move the lever to **RESUME** and release it.

Cruise control is activated at the stored speed.

Adjusting the speed

While the GRA is set, the stored speed can be adjusted:

- Move the lever to the pressure point **RESUME** to increase speed in small increments of 1 km/h (1 mph).
- Move the lever upwards **SPEED+**  to increase in increments of 10 km/h (5 mph).
- Press the button **SET**  **Fig. 151**  to reduce speed in small increments of 1 km/h (1 mph).
- Move the lever downwards **SPEED-**  to reduce in increments of 10 km/h (5 mph).

To change the stored speed without interruption, keep the lever pressed in the direction **SPEED+**  or **SPEED-** . The vehicle adapts the current speed by accelerating or stopping accelerating. The vehicle does not brake actively.

Switching off

- Move the lever to position **OFF**.

The system is disconnected and the memorised speed is deleted.

Speed limiter

Control lamp



It lights up green

The speed limiter is switched on and active.



Flashes green

The speed set by the speed limiter has been exceeded.




It lights up

The adaptive cruise control (ACC) or the speed limiter is active.

The control lamps light up when the ignition is switched on and should turn off after approximately 2 seconds. This is the time taken for the function check.


WARNING



Observe the safety warnings  **in Control and warning lamps on page 85.**

Introduction



Fig. 152 On the instrument panel display: indications of the speed limited status.

The speed limiter helps avoid exceeding a programmed speed, from 30 km/h (19 mph) approx. and faster. 





Depending on the equipment, the speed limited can be operated using the lever of the turn signals  **page 218** or by the third lever  **page 218.**

Display messages on the speed limiter

Status  **Fig. 152:**


- A** The speed limiter is active. The last speed set is displayed in large figures.
- B** The speed limiter is not active. The last speed set is displayed in small or darkened figures.
- C** The speed limiter is switched off. The total mileage is displayed.

Switching between the speed limiter and GRA or ACC (while the speed limiter is connected)

To change between the driving assistance systems, press button  » Fig. 153  or button  » Fig. 154 , then use the right thumbwheel on the multifunction steering wheel to select from the instrument cluster menu and press the thumbwheel to confirm your selection.


It switches between the speed limiter and cruise control (GRA) or the adaptive cruise control (ACC).


Going down slopes with the speed limiter

If the programmed speed is exceeded while driving downhill, after a short time the control warning lamp  » page 216 flashes and an audible warning may sound. Brake and change down a gear.

Temporarily deactivate by pressing the accelerator down

If the accelerator is pressed right down (kick-down) and the set speed is exceeded because driver wishes to do so, the limiter is temporarily disabled.

To confirm it being switched off an acoustic signal sound once. While cruise control is off, the control lamp flashes .

When the accelerator is no longer pressed down and the speed is reduced below the set value, the limiter switches on again. The control lamp  will light up and remain lit.

Automatic off

The speed limiter is automatically switched off:

- If the system detects a fault that could negatively affect the working order of the limiter.
- If the airbag is triggered.

WARNING

After use, switch off the speed limiter to prevent the speed being regulated without it being required.

- The speed limiter does not relieve the driver of their responsibility to drive at the appropriate speed. Do not drive at high speed if not necessary.
- Using the speed limiter in adverse weather conditions is dangerous and can cause serious accidents. Use the speed limiter only when the condition of the road surface and the weather and traffic conditions allow it.
- When driving on a steep gradient, the speed limiter cannot limit the vehicle's speed. This can increase. In this case, brake and change down a gear.

CAUTION

For automatic switching off due to system failures, for security reasons, the limiter is only completely switched off when the driver stops pressing the accelerator or consciously switches it off.

Note

- Different versions of the instrument panel are available and therefore the versions and instructions on the display may vary.
- If the cruise control (GRA), the adaptive cruise control (ACC) or the speed limiter are connected when the ignition is switched off, the assistants will switch it when the ignition is switched on, but only the speed limiter will maintain the last programmed speed.

Operating the speed limiter with the turn signal lever

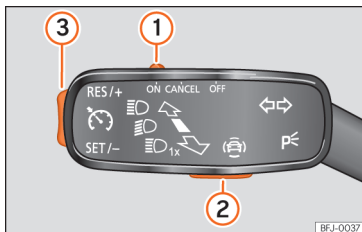


Fig. 153 On the turn signal lever: buttons to operate the speed limiter.

Connecting

- Move control »» Fig. 153 ① to position **ON** and press button ②. Then use the right thumbwheel on the multifunction steering wheel to select the limiter from the instrument cluster menu¹⁾.

The last programmed speed is stored. It does not take effect yet.

Activating the speed limiter

- While driving, press button »» Fig. 153 ③ in the area **SET/-**.

The current speed is stored as the maximum speed.

Setting the programmed speed

You can set the speed using button »» Fig. 153 ③:

- Briefly press area **RES/+** to increase speed in small increments of 1 km/h [1 mph].
- Press and hold the area **RES/+** to continuously increase speed in increments of 10 km/h [5 mph].
- Briefly press area **SET/-** to decrease speed in small increments of 1 km/h [1 mph].
- Press and hold area **SET/-** to continuously decrease speed in increments of 10 km/h [5 mph].

The speed is limited to the set value.

Switching off the speed limiter

- Move control »» Fig. 153 ① to position **OFF**.

The system switches off.

Switching off temporarily

If you want to temporarily deactivate the speed limiter, e.g. for overtaking, move the

control »» Fig. 153 ① to position **CANCEL** or press button ②.

After overtaking, the speed limiter can be activated with the previously programmed speed by pressing button »» Fig. 153 ③ in the area **RES/+**.

Operating the speed limiter with the third lever

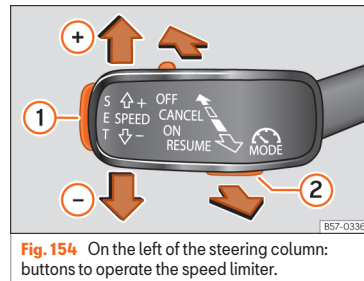


Fig. 154 On the left of the steering column: buttons to operate the speed limiter.

Connecting

- Move the lever towards the steering wheel to position **ON** and press button »» Fig. 154 ②.

¹⁾ Depending on the version, the limiter may activate automatically when button ② is pressed.

The last programmed speed is stored. It does not take effect yet.

Activating the speed limiter

- While driving, press button **SET** »» Fig. 154 ①.

The current speed is stored as the maximum speed.

Setting the programmed speed

The programmed speed can be set:

- Move the lever to the pressure point **RESUME** to increase speed in small increments of 1 km/h (1 mph).
- Move the lever upwards **SPEED+** to increase in increments of 10 km/h (5 mph).
- Press the button **SET** »» Fig. 154 ① to reduce speed in small increments of 1 km/h (1 mph).
- Move the lever downwards **SPEED-** to reduce in increments of 10 km/h (5 mph).

To change the programmed speed without interruption, keep the lever pressed in the direction **SPEED+** (+) or **SPEED-** (-). The speed is limited to the set value.

Switching off the speed limiter

- Move the lever to position **OFF**.

The system switches off.

Switching off temporarily

If you want to temporarily deactivate the speed limiter, e.g. for overtaking, move the lever to the pressure point **CANCEL** or press button »» Fig. 154 ②.

After overtaking, the speed limiter can be activated with the previously programmed speed by moving the lever to the pressure point **RESUME**.

Emergency brake assistance system (Front Assist)*

Introduction



Fig. 155 On the instrument panel display: advance warning indications.

The objective of the system is to prevent head-on collisions against objects that may

be in the vehicle's path or minimise the consequences of such impacts.

Depending on several factors and how critical the situation is, the system operates in a staggered manner. First it warns the driver, and if the driver's reaction does not occur or is insufficient, it activates independent emergency braking.

The function is intended to prevent collisions with parked vehicles or vehicles in the same lane travelling in the same direction, or with pedestrians crossing the vehicle's path. **It may fail to activate in other hazard situations »» ⚠**

Front Assist is active between 4 km/h (2.5 mph) and 250 km/h (156 mph). Depending on a range of conditions, some of the functions described below are omitted to optimize the behaviour of the system.

Front Assist is a driving assistance function that can never replace the driver's attention.

Safety distance warning


If the system detects that you are driving too close to the vehicle in front, it will warn the driver with this indication on the instrument panel display 🚗⚠.

The timing of the warning varies according to other factors: driver behaviour and speed. »

Advance warning

If the system detects a possible collision with the vehicle in front, it alerts the driver by means of an audible warning and an indication on the instrument panel display

»» Fig. 155.

The warning moment varies depending on the traffic situation and driver behaviour. At the same time, the vehicle will prepare for a possible emergency braking »» .

Critical warning

If the driver fails to react to the **advance warning**, the system may actively intervene in the brakes and generate a brief jolt to warn the driver of the imminent danger of a collision.

Automatic braking


If the driver also fails to react to the **critical warning**, the system may initiate independent emergency braking by progressively increasing the braking in accordance with how critical the situation is.

Driver emergency brake assistance system

The system may detect that the driver is not braking hard enough to avoid the collision. In this case, it will increase the braking intensity.

The system cannot prevent a collision, although it can significantly minimise the consequences by reducing the speed and the force of the impact.

WARNING

Observe the safety warnings »»  in Control and warning lamps on page 85.

WARNING

Front Assist cannot change the laws of physics or replace the driver in terms of keeping control of the vehicle and reacting to a possible emergency situation.

WARNING

Following a Front Assist emergency warning, pay immediate attention to the situation and try to avoid the collision as applicable.

- If the Front Assist does not work as described in this chapter (e.g. it repeatedly intervenes unnecessarily), switch it off. Have the system checked by a specialised workshop. SEAT recommends visiting a SEAT dealership.
- Always adapt your speed and distance away from the vehicle in front of you at all times to suit visibility, weather, road and traffic conditions.
- The Front Assist alone cannot avoid accidents and serious injuries.

- In complex driving situations, Front Assist may issue warnings and intervene in braking unnecessarily.
- If the operation of the Front Assist is impaired by dirt or because the radar sensor has lost its settings, the system may issue unnecessary warnings and intervene inopportunity in the braking.
- The Front Assist does not react to animals or vehicles crossing your path or approaching head-on down the same lane.
- The Front Assist does not react to pedestrians walking head-on in the same lane.
- The driver must always be ready to take over the control of the vehicle.

Note

- When Front Assist is connected, the indications of other functions on the screen may be hidden.
- When the Front Assist causes a braking, the brake pedal is "harder".
- Automatic interventions by the Front Assist on the brakes may be interrupted by pressing the clutch, accelerator or moving the wheel.
- The Front Assist may brake the vehicle until it stops completely. However, the brake system does not halt the vehicle permanently. Use the foot brake!

- If the Front Assist does not work as described in this chapter (e.g. in intervenes several times unnecessarily), switch it off.

Operation of the emergency brake assistance system (Front Assist)


The Front Assist is active whenever the ignition is switched on.


When the Front Assist is switched off, so too are the **advance warning** and the **distance warning** functions.

SEAT recommends leaving the Front Assist activated. Exceptions »»» page 221, **Deactivating Front Assist temporarily in the following situations.**


Switching the Front Assist on and off

With the ignition switched on, the Front Assist can be deactivated or activated as follows:

- using the Easy Connect system with the button **CAR /**  **> SETTINGS > Driver assistance** »»» page 90.

When Front Assist is deactivated, the indication  will be displayed on the instrument cluster.

Activating or deactivating the pre-warning (advance warning)

The **advance warning** function can be switched on or off in the Easy Connect system using the button **CAR /**  **> SETTINGS > Driver assistance** »»» page 90.

The system will store the setting for the next time the ignition is switched on.


SEAT recommends keeping advance warning active.

Depending on the vehicle's infotainment system the **advance warning** function may be adapted in the following modes:

- Advance
- Medium
- Delayed
- Deactivated

SEAT recommends driving with the function in "Medium" mode.

Switching distance warning on and off

The distance warning can be switched on and off in the Easy Connect system using the button **CAR /**  **> SETTINGS > Driver assistance** »»» page 90.

The system will store the setting for the next time the ignition is switched on.

SEAT recommends keeping the distance warning active.

Deactivating Front Assist temporarily in the following situations

In the following situations the Front Assist should be deactivated due to the system's limitations:

- When the vehicle is to be towed.
- If the vehicle is on a test bed.
- When the radar sensor is damaged.
- If the radar sensor receives a violent impact.
- If it intervenes several times unnecessarily.
- If the radar sensor is temporarily covered by an accessory.
- When the vehicle is going to be loaded onto transportation.

System limitations



Fig. 156 On the instrument panel display: initial system self-calibration indication.

Front Assist has certain limitations inherent to the system. Thus, in certain circumstances, some of the reactions may be inappropriate from the driver's standpoint. So pay attention in order to intervene if necessary.

The following conditions may cause the Front Assist not to react or to do so too late:

- In the first few instants of driving after switching on the ignition, due to the system's initial auto-calibration. During this period, a status icon »» Fig. 156 is displayed.
- If the Front Assist is switched off or damaged.
- If the radar sensor is dirty or covered.
- On taking tight bends or complex paths.

- Pressing the accelerator all the way down.
- If the ASR has been disconnected or the ESC activated in **Sport** mode »» page 233.
- If the ESC is controlling.
- If several brake lights of the vehicle or electrically connected trailer are damaged.
- If there are metal objects, e.g. guard rails or sheets used in road works.
- If the vehicle is reversing.
- In case of snow or heavy rain.
- In case of narrow vehicles, such as motor-bikes.
- Misaligned vehicles.
- Vehicles crossing the other's path.
- Vehicles approaching in the opposite direction.
- Loads and accessories of other vehicles that protrude over the sides, backwards or over the top.

ACC - Adaptive Cruise Control*

Introduction

Adaptive Cruise Control (ACC) maintains a constant speed set by the driver. When approaching another vehicle in front, the

ACC detects it and adapts the speed automatically, maintaining a distance set by the driver.

Does my vehicle have ACC?

Your vehicle has ACC if it has a third lever to the left of the steering column »» Fig. 157.

Speed range

ACC regulates speeds between 30 km/h (20 mph) and 210 km/h (130 mph).

If the vehicle is fitted with an automatic gearbox, the ACC can bring the vehicle to a standstill if a vehicle in front of it stops.

If your vehicle is fitted with a manual gearbox, you must pay attention to speed and gear changes. The ACC is deactivated if the speed is too low (less than 30 km/h) or the engine RPM is too low or high.

Driver intervention prompt

- Ⓢ ACC is subject to certain limitations inherent to the system. This means that the driver will have to control the speed and distance from other vehicles in certain situations. In this case, the instrument cluster display **will tell you to intervene** by applying the brake, and an audio warning will be played.

Radar sensors

The ACC uses the front radar technology. Read its maintenance instructions and information about its limitations » page 211.

⚠ WARNING

The ACC's technology cannot overcome the system's inherent limitations or change the laws of physics. If used negligently or involuntarily, it may cause serious accidents and injuries. The system is not a replacement for driver awareness.

- Always be prepared to brake or accelerate.
- If you press the accelerator pedal the ACC will stop working. Therefore, it will not brake or request any braking intervention.
- Adapt your speed and safe distance to the vehicle in front of you at all times to suit visibility, weather, road and traffic conditions.
- Do not use the ACC in poor visibility, or on roads that are steep, with lots of curves or slippery.
- Never use ACC when driving off-road or on unpaved roads.
- The system does not react to stationary obstacles (such as a traffic jam queue). React soon enough to avoid a hazardous situation.
- The system does not react to people, animals or vehicles that are crossing or approaching in the opposite direction.

- If you are driving with a spare wheel fitted, the ACC system could automatically switch off. Switch off the system when starting off.
- Brake immediately if the ACC does not slow down enough.
- Brake immediately when a driver intervention instruction is displayed on the instrument cluster screen.
- If the vehicle continues to move involuntarily after a driver intervention prompt, brake the vehicle.

📄 Note

If the ACC does not work as described in this chapter, do not use it until it has been checked by a specialised workshop. Visiting a SEAT dealership is recommended.

ACC operation

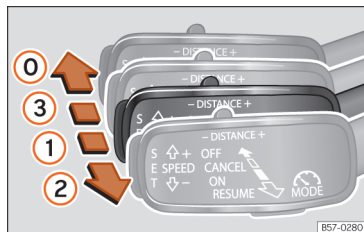


Fig. 157 On the left of the steering column: operating the ACC with the third lever.

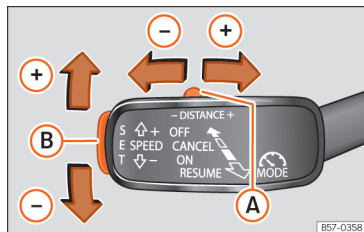


Fig. 158 On the left of the steering column: operating the ACC with the third lever.

Connecting

To switch on the ACC, the position of the ACC lever must be taken into account.

- Move the third lever to position **ON** » **Fig. 157 1**

»

The ACC does not regulate anything yet (standby).

Start regulation

- To start regulation, press button **SET** »» Fig. 158 (B) or move the lever to position **RESUME** »» Fig. 157 (2).

The ACC sets the current speed, or the closest speed within the valid range [30-210 km/h], as the cruise speed.

With manual transmission, the gear lever must be in any gear except first and reverse, and the speed must be higher than approximately 30 km/h [18 mph]. On vehicles with automatic transmission, the gear lever must be in the **D**, **S** or **M** position.

Depending on the driving situation, the following indicator lamps come on:

It lights up green

The ACC is active^{a1}.

^{a1} Only on analogue instrument clusters.

It lights up green^{a1}

ACC connected, no vehicle detected in front.

^{a1} It lights up white on the analogue instrument cluster.

It lights up green^{a1}

ACC connected, vehicle detected in front.

^{a1} It lights up white on the analogue instrument cluster.

When the ACC is in standby, the indicator lamps light up grey.

Setting speed

To set the speed, move the third lever up + or down - to the desired speed »» Fig. 158. The speed is adjusted at intervals of 10 km/h [5 mph].

When the ACC is active, the lever can be moved to position **RESUME** »» Fig. 157 (2) to increase the desired speed by 1 km/h [1 mph]. You can then press **SET** to decrease it by 1 km/h [1 mph].

Setting your distance level

The distance can be set to one of five levels, from very short to very long:

- Move button (A) »» Fig. 158 right or left to increase or decrease the distance.

Keep in mind each country's regulations on minimum braking distances.

Suspend regulation (standby)

- Move the third lever to position **CANCEL** »» Fig. 157 (3) or press the brake pedal.

The ACC indicator lamp is grey; the speed and distance are saved.

If the ESC or ASR is disconnected »» page 233, the ACC is automatically suspended.

Reinstating the cruise control

- Move the third lever to the **RESUME** position to use the last set speed and distance,
- **OR:** Press the **SET** button to use the current speed.

Switching off

- Move the lever to the **OFF** (fixed) (0) position. The set speed is cleared.

Exceeding the speed regulated by the ACC

While driving with the ACC switched on, the driver can increase speed by pressing the accelerator pedal. ACC regulation is suspended until you release the accelerator pedal »» 1.

Adjusting the default distance level at the start of your journey

In the Infotainment system, you can pre-select the distance level when connecting the ACC from:

- Very short, Short, Medium, Long and Very long using the Infotainment system:  **Driver assistance > ACC** » page 90.

Changing the driving profile

In vehicles with SEAT Drive Profile, the driving profile selected can have an influence on the ACC's acceleration and braking behaviour » page 207.

In vehicles without SEAT Drive Profile, the behaviour of the ACC can also be affected if any of the following drive profiles are selected in the infotainment system in **Drive assist**. ACC settings will be the same as those in the SEAT Drive Profile.

WARNING

Before driving off, check that the road is clear. The radar sensor may not detect obstacles on the road. This could cause an accident and serious injuries. If necessary, apply the brake.

CAUTION

If you increase speed using the accelerator pedal, the ACC may not be able to safely adjust the speed of the distance due to the limitations of the system.

- Be prepared to react if required by the situation.

Status display

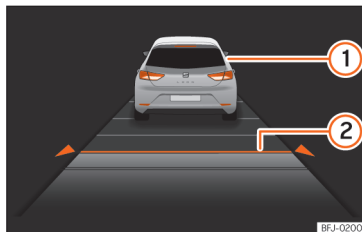


Fig. 159 On the instrument panel display: ACC active.

- ① Vehicle ahead detected. It will light up if the distance to the vehicle is adjusted.
- ② Selected distance level 2.

This information can be displayed on the central panel of the **Assists** view, or in the left hand information profile » page 70. If these views are not selected, it will be automatically displayed in the lower central part of the instrument cluster in a simplified manner.

The set speed will be displayed next to the function status indicator described in » page 224, Start regulation.

Special driving situations

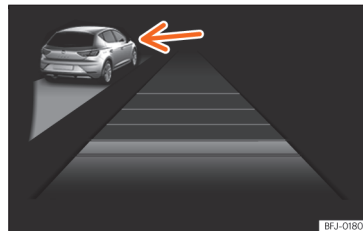


Fig. 160 On the instrument panel display: ACC active, vehicle detected in an outer lane.

Be aware of the limitations and warnings described at the beginning of this chapter. »  in Introduction on page 223.

Avoid undertaking on the right¹⁾

If a vehicle is detected in the left lane that is travelling at a speed slower than that set by the driver, it will brake the vehicle within the comfort limits of the system to avoid passing it on the right » Fig. 160. »

¹⁾ Or on the left, in countries that drive on the left hand side of the road.

You can cancel this regulation by changing the set speed or by pressing the accelerator pedal.

The function works at speeds over 80 km/h (50 mph). It may not be available in certain countries.

Overtaking

When the turn signal is switched on for overtaking, the ACC reduces the distance from the vehicle in front to help with the overtaking manoeuvre. The set cruising speed will not be exceeded.

The function works at speeds over 80 km/h (50 mph). It may not be available in certain countries.

Stop&Go function

✓ **Valid for: vehicles with an automatic gearbox**

The ACC can bring the vehicle to a standstill (0 km/h) if the vehicle in front stops.

The ACC remains active and the message **ACC ready to start** is displayed on the instrument cluster for a few seconds. During this time, the vehicle will move off again if the vehicle in front moves forwards.

If the vehicle in front does not move off, the vehicle can be kept at a standstill with the status **ACC ready to start** by pressing the brake.

The system can only keep the car stopped for a few seconds. After this, the **Brake** warning will be displayed and an audio warning will be played. Press the brake pedal. The vehicle may start moving forward if you do not do this **Accident hazard!**

The ACC is deactivated while stopped in the following cases:

- If the vehicle stops for several minutes.
- If a door is opened.

⚠ WARNING

If the message ACC ready to start is displayed on the instrument cluster display and the vehicle in front moves off, your vehicle will move off automatically. In this case, any obstacles in the road may not be detected. This may cause serious accidents and injuries.

- **Always check the road before moving off, and apply the vehicle brakes yourself if necessary.**

ACC system limitations

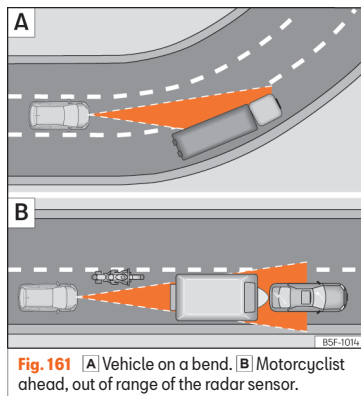


Fig. 161 [A] Vehicle on a bend. [B] Motorcyclist ahead, out of range of the radar sensor.

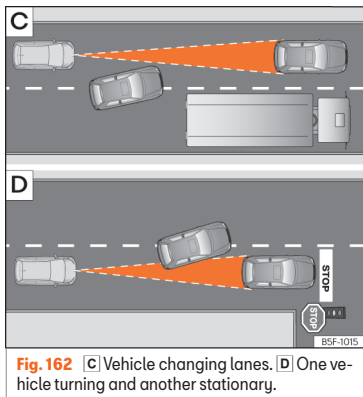


Fig. 162 [C] Vehicle changing lanes. [D] One vehicle turning and another stationary.

The limits of the ACC system mean that it is not appropriate in all situations » **⚠** in **Introduction on page 223**.

SEAT does not recommend using the function in the following cases » **⚠**:

- Heavy rain, snow or fog.
- When going through tunnels.
- In sections with roadworks.
- On routes with curves, e.g. on mountain roads.
- On off-road routes.
- In covered car parks.

- On roads with embedded metal objects such as train or tram tracks.
- On roads with loose gravel.

Pay special attention when using ACC in the following situations:

On curves

The ACC may not detect the vehicle in front on a curve, or may regulate the distance from vehicles in other lanes » **Fig. 161 [A]**.

Vehicles outside the sensor zone

In the following situations the ACC may not react, or may react slowly or inappropriately:

- Vehicles that are not aligned while driving or that are outside the sensor's detection area, such as motorcycles » **Fig. 161 [B]**
- Vehicles that move into your lane, a short distance from your vehicle » **Fig. 162 [C]**.
- Vehicles with loads or accessories that protrude from the sides, rear or roof.

Objects that are not detected

The ACC function only detects and reacts to vehicles moving in the same direction. Therefore it does not detect:

- People
- Animals

- Vehicles travelling in the opposite direction or crossing the road.
- Other stationary obstacles

The ACC does not react to stationary vehicles. If, for example, a vehicle detected by the ACC turns or moves over and there is a stationary vehicle in front of it, the ACC will not react to the second vehicle » **Fig. 162 [D]**.

⚠ WARNING

Using the ACC in the above situations can cause serious accidents and injuries, and you could break the law.

Problems and solutions

! ACC not available

The indicator lamp lights up yellow:

- The radar sensor is dirty or adjusted incorrectly. Take into account the warnings described in this section » **page 212**
- There is a fault or defect. Turn off the vehicle's ignition and turn it on again after a few minutes.
- If the problem persists, consult a specialised workshop.

»

The ACC does not work as expected

- Make sure that the conditions are met for the radar sensor to operate properly »» page 212.
- If the brakes overheat, regulation stops automatically. Wait for them to cool down and check the operation again.
- Unusual noises during automatic ACC braking are normal and do not indicate any anomalies.

The following conditions may lead the ACC not to react:

- The accelerator or brake is depressed.
- No gear is engaged or the vehicle is in gear R.
- The vehicle is reversing.
- ESC is operating.
- The driver is not wearing his/her seat belt.
- A vehicle or trailer brake light is faulty.
- The RPM is too high or too low.
- The parking brake is applied.
- Driving on an excessive slope.

Braking and parking

Braking system

Control lamps

(i) It lights up red

Brake fluid level too low »» page 271 or fault in the brake system.

 **Do not carry on driving!**

(P) It lights up red

Handbrake applied »» page 230.

The warning lamp turns off when the handbrake is released.

⚠ WARNING

- **If the brake warning lamp (i) does not go out or if it lights up when driving, the brake fluid level in the reservoir is too low so there is a risk of an accident »» page 271, Brake fluid. Stop the vehicle and do not drive on. Obtain technical assistance.**
- **If the brake warning lamp lights up (i) together with the ABS lamp (ABS) this could be due to an ABS fault. When this function fails, the rear wheels can lock up. Under certain circumstances, the rear of the vehicle may skid, with the danger of losing control. Stop and seek technical assistance.**

Information about the brakes

New brake pads

For the first 200 to 300 km (100 to 200 miles), new brake pads have not yet reached their maximum braking capacity, and need to be “run in” first. However, you can compensate for the slightly reduced braking effect by applying more pressure on the brake pedal. Avoid overloading the brakes while running them in.

Wear

The rate of wear on the **brake pads** depends a great deal on how you drive and the conditions in which the vehicle is operated. This is a particular problem in urban traffic and short stretches, or with very sporty driving.

Depending on the speed, the braking force and the environmental conditions (e.g. temperature, air humidity, etc.) noises may be produced when braking.

Wet roads or road salt

In certain situations (for example, on driving through flooded areas, in severe downpours or after washing the vehicle) the braking action could be delayed if the discs and pads are damp, or frozen in winter. In this case the brakes should be “dried” by pressing the brake pedal several times.

At high speed and with the windscreen wipers activated, the brake pads will briefly touch the brake discs. This takes place, although unnoticeable to the driver, at regular intervals to improve the response time of the brakes when they are wet.

The effectiveness of the brakes can also be temporarily reduced if the vehicle is driven for some distance without using the brakes when there is a lot of salt on the road in winter. The layer of salt that accumulates on the discs and pads can be removed by gently applying the brakes a few times.

Corrosion

There may be a tendency for corrosion to form on the discs and dirt to build up on the brake pads if the vehicle is used infrequently or the brakes are not used very often.

If the brakes are not used frequently, or if rust has formed on the disks, it is advisable to clean off the pads and disks by braking firmly a few times at a moderately high speed »» » ⚠.

Fault in the brake system

If the brake pedal travel should ever increase *suddenly*, this may mean that one of the two brake circuits has failed. Drive immediately to the nearest specialised workshop and have the fault repaired. Drive there slowly and remember that you will have to apply more

pressure on the brake pedal and allow for longer stopping distances.

Low brake fluid level

Malfunctions can occur in the brake system if the brake fluid level is too low. The brake fluid level is monitored electronically.

Brake servo

The brake servo increases the pressure you apply to the brake pedal. It works only when the engine is running.

⚠ WARNING

Any anomaly in the brake system can increase the braking distance, with the resulting risk of an accident.

- New brake pads and discs must be run in and do not have the correct friction during the first 200 km (124 miles). This reduced braking capacity may be offset by pressing on the brake pedal a little harder.
- If you are driving on roads which have been salted, braking effectiveness may be decreased.
- Brakes can overheat if used excessively on slopes. Before driving down a long steep slope, it is advisable to reduce speed and change down into a lower gear or range. Therefore, using the engine brake relieves the brakes.
- Gentle continuous braking causes the brakes to overheat and the braking dis-

tance will increase. Apply and then release the brakes alternately.

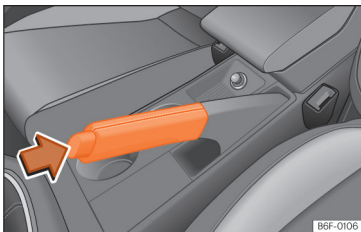
- Apply the brakes heavily to clean the brake system only in a suitable traffic situation. Do not put other road users in danger: there is risk of causing an accident.
- Ensure the vehicle does not move while in neutral, when the engine is stopped. The braking distance is increased considerably when the brake servo is not active.
- If the brake is subjected to high stresses, vapour bubbles may form in the brake system's pipes. This reduces the efficiency of the brakes.
- Non-standard or damaged front spoilers could restrict the airflow to the brakes and cause them to overheat. Before purchasing accessories please read the relevant instructions.

ⓘ CAUTION

- Never let the brakes "drag" by leaving your foot on the pedal when it is not necessary to brake. This overheats the brakes, resulting in longer stopping distances and greater wear.
- Before driving down a long, steep gradient, it is advisable to reduce speed and select a lower gear. This makes use of engine braking and relieves the brakes. If you still have to use the brakes, it is better to brake firmly at intervals than to apply the brakes continuously. »

Note

- If the brake servo is out of action, for example when the car is being towed, you will have to press the brake pedal considerably harder than normal to make up for the lack of servo assistance.
- If you wish to equip the vehicle with accessories such as a front spoiler or wheel covers, it is important that the flow of air to the front wheels is not obstructed, otherwise the brakes can overheat.

Handbrake**Fig. 163** Handbrake between the front seats.

The handbrake should be applied firmly to prevent the vehicle from accidentally moving. Apply the handbrake when you leave your vehicle and when you park.

Applying the handbrake

- Pull the handbrake lever up »» Fig. 163.

Releasing the handbrake

- Pull the lever up slightly and press the release knob in the direction of the arrow »» Fig. 163 and guide the handbrake lever down fully »» ⚠.

Always pull the handbrake *all the way up*, to avoid driving off while the brake is on »» ⚠.

⚠ WARNING

- Never use the handbrake to stop the vehicle when it is in motion. The braking distance is considerably longer, because braking is only applied to the rear wheels. Risk of accident!
- Failure to fully lower the handbrake lever can affect the operation of the system, and can also cause heating and wear of the rear brakes.

ⓘ CAUTION

Always apply the handbrake before you leave the vehicle. In addition, engage first or rear gear in the gradient function, or set the selection lever to P.

Hill driving assistant*

✓ Valid for vehicles: with ESC

The hill driving assistant helps the driver to move off and upward on a hill, both forwards and backwards, when the vehicle is stationary.

The system maintains brake pressure for approximately two seconds after the foot is taken off the brake pedal, to prevent the vehicle from moving when it is started. During these 2 seconds, the driver has enough time to release the clutch pedal and accelerate without the vehicle moving and without having to use the handbrake, making start-up easier, more comfortable and safer.

These are the basic operation conditions:

- being on a ramp or hill/slope,
- driver door closed,
- vehicle completely stationary,
- engine running and foot on the brake,
- having a gear engaged or being in neutral for a manual gearbox, or with the selector lever at positions **D/S** or **R** for an automatic gearbox.

⚠ WARNING

- If you do not start the vehicle immediately after taking your foot off the brake pedal, the vehicle may roll back under certain

conditions. Depress the brake pedal or use the hand brake immediately.

- If the engine stalls, depress the brake pedal or use the hand brake immediately.
- When following a line of traffic uphill, if you want to prevent the vehicle from rolling back when starting off, hold the brake pedal down for a few seconds before starting off.

Note

The Official Service or a specialist workshop can tell you if your vehicle is equipped with this system.

Stabilisation and brake assistance systems

Control lamps*



It lights up

Fault in the ESC or ABS, or disconnection caused by the system.
The ESC works in combination with the ABS. If the ABS fails, the lamp also lights up.



Flashes

ESC or ASR activated.



It lights up

ASR manually deactivated.

Or: ESC in Sport mode »» page 233.




It lights up

ABS faulty or does not work.

The control lamps light up together when the ignition is switched on and should turn off after approximately 2 seconds. This is the time taken for the function check.

Brake assist systems

Electronic Stability Control (ESC)*

The ESC helps to improve safety. It reduces the tendency to skid and improves the stability and roadholding of the vehicle. The ESC detects critical handling situations, such as vehicle understeer or oversteer, or wheelspin on the driving wheels. It stabilises the vehicle by braking individual wheels or by reducing the engine torque. The warning lamp will flash on the instrument panel when the ESC is intervening .

The ESC includes the anti-lock brake system (ABS), the hydraulic brake assist (HBA), the traction control system (ASR), electronic differential lock (EDS), electronic torque control (XDS).

ESC also helps stabilise the vehicle by changing the torque.

The ASR can be deactivated when wheel spin is desirable »» page 233.

Anti-lock brake system (ABS)

ABS prevents the wheels from locking up under braking until the vehicle has reached a virtual standstill. You can continue to steer the vehicle even when the brakes are on full. Keep your foot on the brake pedal and do not pump the brakes. You will feel the brake pedal pulsate while the ABS is working.

If the running gear or brake system is modified, the effectiveness of the ABS could be severely limited.

Hydraulic Brake Assist (HBA)*

The brake assist system can reduce the required braking distance. The braking force is automatically boosted if you press the brake pedal quickly in an emergency. You must keep pressing the brake pedal until the danger has passed.

Traction control system (ASR)

In the event of wheelspin, the traction control system reduces the engine torque to match the amount of grip available. This helps the car to start moving, accelerate or climb a gradient.



Electronic differential lock (EDL)*

When the EDL detects wheelspin, it brakes the spinning wheel and directs the power to the other driven wheel. This function is active up to approximately 100 km/h (62 mph).

To prevent the disc brake of the braked wheel from overheating, the EDL cuts out automatically if subjected to excessive loads. The vehicle can still be driven. The EDL will switch on again automatically when the brake has cooled down.

Tractor-trailer sway mitigation*

If the vehicle is pulling a trailer, it will control the following: tractor-trailers tend to sway. When the swaying of the trailer is felt by the vehicle and detected by the ESC, it will automatically brake the towing vehicle within the limits of the system and mitigate the sway. Tractor-trailer sway mitigation is not available in all countries » page 248.

Electronic engine torque management (XDS)*

When taking a curve, the driveshaft differential allows the outer wheel to turn at a higher speed than the inner wheel. In this way, the wheel that is turning faster (outer wheel) receives less drive torque than the inner wheel. This may mean that in certain situations the torque delivered to the inner wheel is too high, causing the wheels to spin. On the other

hand, the outer wheel is receiving a lower drive torque than it could transmit. This can cause a loss of grip on the drive axle, in this case the front axle, which results in understeer or "lengthening" of the trajectory.

The XDS can detect and correct this effect via the sensors and signals of the ESC.

Via the ESC, the XDS will brake the inside wheel and counter the excess driving torque of that wheel. This means that the requested trajectory is much more precise.

XDS works in combination with the ESC and is always active, even when ASR is disconnected, or when the ESC is in Sport mode or disconnected.

Multi-collision brake

The multi-collision brake consists of automatic braking activated by the Airbag control unit. It is activated when, in the event of an accident, the Airbag control unit detects decelerations above the activation level, and braking is managed by the ESC system.

In the event of an accident, the multi-collision brake can help the driver by braking to avoid the risk of skidding during the accident and causing other collisions.

The following actions control automatic braking during the accident:

- When the driver presses the accelerator, the automatic braking does not take place.

- When the braking pressure through pressing the brake pedal is greater than the system's braking pressure the vehicle will brake automatically.
- Multi-collision braking will not be available if there is an anomaly in the ESC system.



WARNING

Driving at high speed on icy, slippery wet ground can result in loss of vehicle control and serious injury to the driver and passengers.

- The ESC, ABS, ASR, EDS and the electronic torque control system cannot exceed the limits imposed by the laws of physics. Always bear this in mind, especially on wet or slippery roads. If you notice the systems cutting in, you should reduce your speed immediately to suit the road and traffic conditions. Do not be encouraged to take risks by the presence of more safety systems. If you do, an accident may occur.
- Please remember that the accident risk always increases if you drive fast, especially in corners or on a slippery road, or if you follow too close behind the vehicle in front of you. The ESC, ABS, brake assist, EDS and the electronic torque control system cannot prevent accidents: risk of accidents!
- Accelerate with caution on slippery surfaces (for example, icy or snow-covered). Despite the control systems, the driven

wheels could spin, affecting the stability of the vehicle: risk of accident!

Note

- The ABS and ASR will only operate correctly if the four wheels have identical tyres. Any differences in the rolling radius of the tyres can cause the system to reduce engine power when this is not desired.
- The regulating processes of the systems can make noises due to their operation.
- If the warning lamp  or  lights up, there could be a fault »» page 84.
- Any modifications made to the vehicle (for example, to the engine, brake system, running gear or to the combination of wheels and tyres) may affect the operation of the ABS, ASR and EDS.

Connecting and disconnecting the ESC and ASR*


The ESC is switched on automatically when the engine is started, and only works when the engine is running and includes the ABS, EDS and ASR systems.

The ASR function should only be switched off in situations in which traction is insufficient.

Depending on the finishes and versions, there is the possibility of disconnecting only the ASR or activating the ESC in "Sport" mode.


Disconnecting and connecting the ASR

- The ASR can be disconnected and connected using the Easy Connect system »» page 86. In vehicles with a driver information system* the corresponding indication will be displayed.

When the ASR is disconnected, the control warning light  lights up on the instrument cluster.

Disconnecting and connecting the ESC in "Sport" mode

- In "Sport" mode, the ESC can be disconnected and connected using the Easy Connect system »» page 86. In vehicles with a driver information system* the corresponding indication will be displayed.

When "Sport" mode is turned on, ESC interventions to stabilise the vehicle, and anti-slip regulation (ASR) are limited. In addition, the  control lamp lights up on the instrument panel.

WARNING

The ESC Sport mode should be activated only when traffic conditions and the ability of the driver allow it. Danger of skidding!

- With ESC in Sport mode, the stabilising function will be limited to allow for a sportier drive. The driving wheels could spin and the vehicle could skid.

Note


If the ASR is disconnected or the Sport mode is selected, cruise control* will be switched off.

Parking

To park the vehicle

When parking your vehicle, all legal requirements should be observed.

Always note the following points when parking the vehicle:

- Park the vehicle on a suitable surface »» .
- Apply the handbrake »» page 230.
- For an automatic gearbox, move the selector lever to position **P**.
- Switch the engine off and remove the key from the ignition. Turn the steering wheel slightly to engage the steering lock.
- With a manual gearbox, engage first gear on flat ground and slopes, or even reverse gear on hills, and release the clutch pedal. »

- When leaving the vehicle, take all keys with you.

Additionally, on steep slopes and inclines

Before switching off the engine, rotate the steering wheel so that if the vehicle should move, it will be held by the kerb.

- On slopes, turn the front wheels so that they are against the edge of the kerb.
- Uphill, turn the wheels towards the centre of the road.

WARNING

- Avoid parking the vehicle where the hot exhaust system could ignite inflammable materials, such as dry grass, low bushes, spilt fuel or flammable materials.
- Do not leave passengers inside a closed vehicle, they may not be able to open doors or windows. Locked doors hinder the possibility of a rescue.
- Children should not be left alone in the vehicle. They could tamper with the hand-brake or the gears, which could cause the vehicle to move without control.
- Depending on weather conditions, it may become extremely hot or cold inside the vehicle. This can be fatal.

Note

In vehicles with automatic transmission, the key can only be removed from the ignition when the lever is in position P.

Help with parking and manoeuvring

Parking aid parking and manoeuvring (ParkPilot)*

Introduction

These assist systems help you when parking and manoeuvring:

- **Park assist plus.** It is an assistant that gives a visual and audio warning of obstacles detected in *front* and *behind* the vehicle »» page 236.
- **Rear parking aid.** An audio assistant that warns about obstacles detected *behind* the vehicle »» page 238.

WARNING

- Always pay attention, by looking directly, to traffic and the area around the vehicle. Assistance systems are not a replacement for driver awareness. Responsibility always lies with the driver.
- The sensors have blind spots in which obstacles and people are not detected. Pay special attention to children and animals.
- Always keep visual control of the surroundings: use the mirrors for additional help.

ⓘ CAUTION

Parking distance warning system functions can be affected by different factors that can cause damage:

- Under certain circumstances, the system does not detect or display certain objects:
 - Chains, trailer draw bars, bars, fences, posts and thin trees.
 - Objects that are located above the sensors, such as protrusions in a wall.
 - Objects with certain surfaces or structures, such as wire mesh fences or powder snow.
- Certain surfaces of objects and garments do not reflect the ultrasound sensors' signals. The system cannot detect these objects or people wearing such clothes correctly.
- Sensor signals may be affected by external sound sources. This may prevent them from detecting people or objects.
- If the system warns you of the proximity of a low obstacle, please note that after being detected by the system, the obstacle in question may disappear from the measurement sensors as the vehicle moves closer, and the system will no longer warn of its presence. In certain circumstances, objects such as high kerbs that could damage the underside of the vehicle are not detected.

- If the parking distance warning system is ignored, the vehicle could suffer considerable damage.
- Damage to the radiator grille, bumper, wheel arch and vehicle underbody can modify the orientation of the sensors. This can affect the parking aid function. Have the function checked by a specialised workshop.
- A number plate or number plate holder with dimensions that exceed the space for the number plate, or a cured or deformed number plate can cause false detections or a loss of visibility for the sensors.

ⓘ Note

- The display on the Easy Connect screen shows a slight time delay.
- In certain situations, the system can give a warning even though there is no obstacle in the detected area:
 - Rough or cobbled surfaces or surfaces with long grass.
 - External ultrasound sources, such as other vehicles equipped with ultrasound systems.
 - Heavy rain or snow, hail or dense exhaust gases.
 - If the number plate is not properly secured to the surface of the bumper.
 - Gradient changes.

- In order to guarantee good operation, keep the sensors clean, free of snow and ice, and do not cover them with stickers or other objects.
- If you use high-pressure or vapour equipment for cleaning, do not apply it directly, unless you do so very briefly, and always keep a distance of more than 10 cm away.
- Fitting certain accessories to the front of the vehicle, such as a plate holder with advertising, may interfere with the operation of the Park Assist.
- We recommend that you practice parking in an area without traffic.
- The volume and tone of the signals and indications can be changed »» page 239.
- In vehicles *without* an infotainment system, these parameters can be modified in a SEAT Official Service or in a specialised workshop.
- Please observe information on towing a trailer »» page 239.

Parking System Plus*

Description

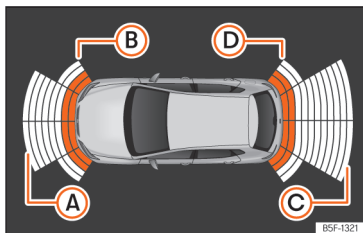


Fig. 164 Parking aid view on the Infotainment system display.

Parking aid plus assists the driver by giving visual and audio warnings about obstacles detected in front of and behind the vehicle.

The bumpers are fitted with sensors. When an obstacle is detected, it is indicated by audible signals and in the Easy Connect system

»» **Fig. 164.**

When moving close to an obstacle, it is possible to know if the obstacle is in front of the vehicle or behind it by choosing different sounds.

The approximate measurement range of the sensors is:

A 1.20 m

B 0.60 m

C 1.60 m

D 0.60 m

As you approach the obstacle, the frequency of the audible signals will increase. The signal will sound continuously at around 0.30 m: Stop!

If the separation is maintained, the warning volume is reduced after about 4 seconds.

Parking Aid operation



Fig. 165 Centre console: parking aid button (depending on the version).

Manually connecting and disconnecting the parking aid

- Press the **P** button *once*.

Manual disconnection of Parking Aid display (the audible sounds remain active)

- Press a button on the main menu of the factory-assembled infotainment system.
- **OR** press the **BACK** ↩ function button.

Automatic connection of Parking Aid

- Select reverse gear.
- **OR:** If you drive forward at a speed of less than 15 km/h (9 mph) and an obstacle is encountered, it is detected when it is approx. less than 95 cm. away. If the automatic connection is activated, a reduced view is shown.
- **OR:** if the vehicle moves back a certain distance (between approx. 10 and 20 cm approx depending on whether or not an obstacle is detected)

Automatic disconnection of Parking Aid

- Move the selector lever to position **P**.
- **OR:** drive forwards at 15 km/h (9 mph) or faster.

Temporary suppression of sound in Parking Aid

- Press the **🔇** function button.

Change from reduced view to full view

- Select reverse gear.
- **OR:** press the car icon on the reduced view.

- **OR:** if the vehicle moves back a certain distance (between approx. 10 and 20 cm approx depending on whether or not an obstacle is detected).

Switch to the reverse assist image (Rear View Camera "RVC")*

- Select reverse gear.
- **OR** press the **RVC** function button.

A short confirmation signal will be heard and the button symbol will light up when the system is switched on.

Automatic activation

When the **Plus Parking Aid** connects automatically, a diagram of the vehicle and the segments will appear on screen.


It only operates every time the speed is reduced below 15 km/h (9 mph) for the first time.

If it is switched off using the **P_{na}** button, one of the following actions must be taken for it to reactivate automatically:

- Switch off the ignition and switch it on again.
- **OR:** drive forward at over 15 km/h (9 mph) approx.

- **OR:** move the lever into position **P** and pack again.
- **OR:** switch the automatic activation on and off in the Easy Connect system.

The automatic activation of the parking aid can be switched on and off in the Easy Connect system »» page 86:

- Switch the ignition on.
- Select: infotainment button **CAR /**  **> SETTINGS > Parking and manoeuvring.**
- Select **Automatic activation**. If the box is checked , the function is connected.

If activated automatically, an audible sound warning will only be given when obstacles in front are at a distance of less than 50 cm. approx.

CAUTION

The automatic connection of the Parking Aid only works when you are driving slowly. If driving style is not adapted to the circumstances, an accident and serious injury or damage may be caused.

Visual indication segments

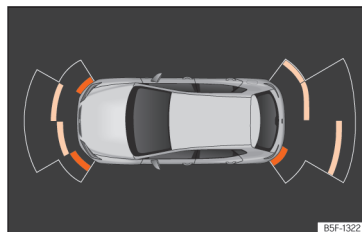


Fig. 166 Parking aid view on the Infotainment system display.



The optical indication of the segments works as follows:

- **White segments:** the obstacle is more than approx. 30 cm away from the path or in the direction opposite to travel.
- **Yellow segments:** the obstacles lie on the vehicle's path and are at a distance of less than approx. 30 cm away.
- **Segmentos rojos:** obstacles are less than approx. 30 cm away.

The Media System Plus or Navi System will display the expected path, depending on how the steering wheel is turned.

If an obstacle is located in the vehicle's way, the corresponding audible warning will sound.



When the penultimate segment is displayed, the vehicle has reached the collision zone. In the collision zone, the obstacles are represented in red, including those out of the path. Stop the vehicle! »»  in Introduction on page 234, »»  in Introduction on page 235!

Setting the indications and audio signals

The indications and audio signal settings are in Easy Connect* »» page 86.

Automatic activation

on – off.

Front volume*

Volume in the front and rear area.

Front sound settings/sharpness*

Sound tone in the front area.

Rear volume*

Volume in the rear area.

Rear sound settings/sharpness*

Sound tone in the rear area.






Adjust volume

When the parking aid is switched on, the volume of the audio source will be reduced, depending on the selected option.

Error messages


If an error or fault message appears on the instrument cluster in Park Assist, there is a fault.

If the fault doesn't disappear before disconnecting the ignition, it will not be indicated next time the parking aid is connected.

If a rear sensor is faulty, only the obstacles in the areas  and  are displayed »» Fig. 164. If a front sensor is faulty, only the obstacles in the areas  and  will be displayed. Symbol  is displayed.

We recommend taking the vehicle to a specialised workshop to have the fault repaired.

Trailer mode

On vehicles with a factory-fitted trailer hitch, when the trailer is connected, the rear sensors will not activate when reverse gear is engaged or button  is pressed. Therefore, any objects behind or to the side of the vehicle will not be indicated on the screen and no audio signals will sound.

The screen will only display objects detected at the front, and the vehicle's trajectory will be hidden.

Rear parking aid*

Description

The **rear parking aid** is an audible assistant that warns of obstacles located *behind* the vehicle.



There are sensors integrated in the rear bumper. When they detect an obstacle, you are alerted by audible warnings and visually on the Easy Connect system.

Make particularly sure that the sensors are not covered by adhesives, residues, dirt and the like, as this could affect the system's operation. Cleaning instructions »» page 290.

The approximate measurement range of the rear sensors is:

Side area: 0.60 m

Central area: 1.60 m

As you approach the obstacle, the frequency of the audible signals will increase. The signal will sound continuously at around 0.30 m: Stop! »»  in Introduction on page 234, »»  in Introduction on page 235!

If the separation is maintained, the warning volume is reduced after about 4 seconds.

Parking Aid operation

Parking Aid connection

- Select reverse gear.

Parking Aid disconnection

- Place the selector level in position **P, N** or **D** (for automatic gearboxes) or disengage reverse (for manual gearboxes).

Setting the indications and audio signals

The indications and audio signal settings are in Easy Connect* »» page 86.

- **Rear volume***: volume in the rear area.
- **Rear sound settings/treble***: sound tone in the rear area.
- **Lower volume**: when the parking aid is switched on, the volume of the audio source will be reduced, depending on the selected option.

Error messages

If an error or fault message appears on the instrument cluster in Park Assist, there is a fault.

If the fault doesn't disappear before disconnecting the ignition, it will not be indicated next time the parking aid is connected.

We recommend taking the vehicle to a specialised workshop to have the fault repaired.

Towing device

In vehicles equipped with a towing bracket device from the factory, when the trailer is connected, the parking aid will not be activated when reverse gear is engaged.

Reverse Assist (Rear View Camera)*

Operating and safety warnings

WARNING

- The reverse assist does not make it possible to precisely calculate the distance from obstacles and nor can it overcome the system's own limits, hence its negligent use may cause serious accidents and injuries if used without due care. The driver should be aware of his/her surroundings at all times to ensure safe driving.
- The camera lens expands and distorts the field of view and displays the objects on the screen in a way that is different from

reality. Distance perception is also distorted.

- Due to the screen resolution or light conditions, some items may be blurry or not displayed at all. Take care with thin posts, fences, railings or trees that might not be seen on the screen and could damage the vehicle.
- The reverse assist has blind spots where it cannot see people or objects. Monitor the vehicle's surrounding area at all times.
- The system is not a replacement for driver awareness. Supervise the parking manoeuvre and the vehicle's surrounding area at all times.
- Do not be distracted from the traffic by looking at the screen.
- The images are only two-dimensional. Protruding objects or holes in the road, for example, are more difficult to detect or may not be seen at all.
- Vehicle load modifies the representation of the guide lines »» Fig. 167. The width represented by the lines decreases with vehicle load. Pay special attention to the surroundings when the inside of the vehicle or the luggage compartment are loaded.
- In the following situations, objects or other vehicles appear to be further away or closer than they actually are. Pay special attention:
 - If moving from a flat surface to a slope and vice-versa.



- If the vehicle is heavily loaded.
- When the vehicle approaches objects that are not on the ground surface or that protrude from it. These objects may be outside the camera angle when reversing.

Note

- It is important to take great care and pay special attention if the driver is not familiar with the system.
- Reverse assist will not be available if the rear lid is open.

Usage instructions

A camera on the rear bumper aids the driver when reverse parking or manoeuvring »» page 213

The camera image is viewed together with orientation lines projected on the Infotainment system screen. Part of the bumper can be seen at the bottom, which can be used by the driver as a reference point.

Rear assist settings

Rear assist offers the user the possibility to change the image's *brightness*, *contrast* and *colour* settings.

To change these settings:

- Stop the vehicle in a safe place without switching off the ignition or the infotainment system.
- Apply the parking brake.
- Select reverse gear.
- Press the $\star\%$ function button displayed on the screen.
- Make the desired adjustments on the menu by pressing the $-/+$ function buttons or by moving the scroll button.

Requirements for parking and manoeuvring with the rear assist

The system should not be used in the following cases:

- If the image displayed is not very reliable or is distorted, or if the lens is dirty.
- If the area behind the vehicle is incomplete.
- If the vehicle is heavily loaded.
- If the position of the camera has changed after a rear-end collision. Have the system checked by a specialised workshop.

Familiarising yourself with the system

To familiarise yourself with the system, the orientation lines and their function, SEAT recommends practising in a place without too much traffic or in a car park when there are good weather and visibility conditions.

Parking and manoeuvring with reverse assist

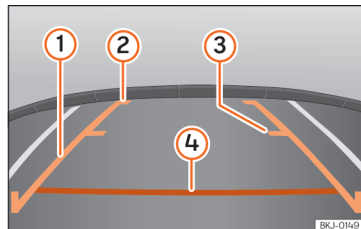


Fig. 167 Display on the Easy Connect system screen: guide lines.

Meaning of the orientation lines »» Fig. 167

- ① **Lateral lines:** extension of the vehicle (approximately in its total width) on the road.
- ② **End of the side lines:** approx. 2 m behind the vehicle on the road.
- ③ **Intermediate line:** approx. 1 m behind the vehicle on the road.
- ④ **Horizontal red line:** a safe distance of approx. 40 cm at the rear of the vehicle on the road.

Switching the system on and off

- Reverse assist is connected by a contact when engaging reverse gear.

- The system switches off 8 seconds after disengaging reverse gear and immediately after removing the contact.
- The camera will stop transmitting images above the speed of 15 km/h [9 mph] with reverse engaged.

In combination with the parking aid plus system » page 236, the camera image will no longer be displayed when reverse gear is disengaged, and the system will display the optical information provided by the parking aid system.

It is also possible to hide the reverse assist image:

- By pressing one of the Infotainment system buttons on the display.
- **OR:** by clicking on the miniature vehicle shown on the screen.

If you wish to display the rear assist image again:

- Disengage and re-engage reverse gear.
- **OR:** Press the **RVC** function button¹⁾

Parking manoeuvre

- Stop the vehicle in front of a space and select reverse gear.

¹⁾ The RVC button will only be displayed when reverse gear is engaged.

- Reverse slowly, and turn the steering wheel so that the side lines lead towards the parking space.
- Guide the vehicle into the parking space so that the side lines run parallel to it.

Towing bracket device*

Trailer mode

Introduction

Take into account country-specific regulations about driving with a trailer and the use of a towing bracket.

The vehicle has been developed primarily for carrying people, although it can also be used to tow a trailer if fitted with the corresponding technical equipment. This additional load has an effect on the useful life, fuel consumption and vehicle performance and in some cases can reduce the service intervals.

Driving with a trailer requires more force from the vehicle, and thus more concentration from the driver.

In winter, winter tyres should be fitted on both the vehicle **and** the trailer.

Maximum vertical load technically permitted on the coupling device

The *maximum* technically permitted vertical load of the tow bar on the hitch of the towing device is **50 kg**. »

Vehicles with the Start-Stop system

If the vehicle has a factory-fitted towing bracket or one that is retrofitted by SEAT, the Start-Stop system operates as normal. No special characteristics need to be taken into account.

If the system does not recognise the trailer or the trailer bracket has not been retrofitted by SEAT, the Start-Stop system must be disconnected by pressing the corresponding button in the lower part of the centre console before driving with the trailer, and it should remain off for the rest of the journey »» ⚠.

Vehicles with driving profile selection

If you are going to be towing a trailer, the use of the **Eco** driving profile is not recommended. You are advised to select another of the available driving profiles before beginning to drive with a trailer.

Trailer weight/drawbar load

Never exceed the authorised trailer weight. If you do not load the trailer up to the maximum permitted trailer weight, you can then climb correspondingly steeper slopes.

The maximum trailer weights listed are only applicable for **altitudes** up to 1000 m above sea level. Since higher altitude decreases engine performance and the ability to climb slopes, the tow load decreases proportionally. The weight of the vehicle and trailer com-

ination must be reduced by 10% for every 1000 m of altitude. When possible, operate the trailer with the maximum **authorised drawbar load** on the ball joint of the towing bracket, but **do not exceed** the specified limit.

⚠ WARNING

Never use the trailer to transport people, since it would put their life in danger and is also prohibited.

⚠ WARNING

Undue use of the towing bracket may cause injury and accidents.

- Only use the towing bracket if it is in a perfect state of repair and is properly secured.
- Never modify or repair the towing bracket in any way.
- In order to reduce the danger of injury in the event of rear-end collisions and to avoid injury to pedestrians and cyclists when parking the vehicle, cover or remove the tow hook when you are not using a trailer.
- Never fit a towing bracket "with weight distribution" or "load compensation". The vehicle has not been designed for this type of towing bracket. The towing bracket could fail and the trailer could be released from the vehicle.

⚠ WARNING

Driving with a trailer and transporting heavy or large objects can affect driving properties and even cause an accident.

- Always secure the load properly using belts or straps that are suitable and in good condition.
- Adapt your speed and driving style at all times to suit visibility, weather, road and traffic conditions.
- Trailers with a high centre of gravity are more likely to overturn than those with a low one.
- Avoid sudden braking and manoeuvres.
- Take great care when overtaking.
- Reduce speed immediately if you notice that the trailer is swaying, however slightly.
- Never drive at more than 80 km/h (50 mph) when towing a trailer (or at more than 100 km/h (60 mph) in exceptional circumstances). This also applies in countries where driving at higher speeds is permitted. Take into account the speed limit for vehicles with trailers in the corresponding country, as it could be less than the speed limit for vehicles without a trailer.
- Never attempt to "straighten" the towing vehicle and trailer while accelerating.

⚠ WARNING

If the towing bracket has been retrofitted by a non-SEAT workshop, the Start-Stop

system must be disconnected manually whenever driving with a trailer. Otherwise the brake system could be damaged and could consequently cause a serious accident or injury.

- Always disconnect the Start-Stop system manually when using a towing bracket that has not been fitted by a SEAT workshop.

i Note

- Before hitching or unhitching a trailer, always deactivate the anti-theft alarm »» page 98. Otherwise, the tilt sensor could cause the alarm to go off.
- Do not drive with a trailer for the engine's first 1000 km »» page 208.
- SEAT recommends that, if possible, the tow hook be removed or covered when it is not going to be used. In the event of a rear-end collision, the damage to the vehicle could be greater if the tow hook is fitted.
- Some retrofitted towing brackets cover the rear towing eye. In these cases, the towing eye should not be used for tow-starting or for towing other vehicles. For this reason, if the vehicle has been retrofitted with a towing bracket, always keep the tow hook in the vehicle when you remove it.

Technical requirements

Vehicles that are **factory**-fitted with a towing bracket meet all the technical and legal requirements for driving with a trailer »» page 248.

If the **vehicle is retrofitted** with a towing bracket, only a bracket that is authorised for the maximum authorised load of the trailer that is to be towed may be fitted. The towing bracket must be suitable for the vehicle and the trailer and must be properly secured to the vehicle's chassis. Only use a towing bracket that has been authorised by SEAT for this vehicle. Always check and take into account the towing bracket manufacturer's instructions. Never fit a towing bracket "with weight distribution" or "load compensation".

Towing bracket fitted on the bumper

Never fit a towing bracket to the bumper or to the area where the bumper is mounted. The towing bracket should not impair the bumper's function. Do not make modifications or repairs to the exhaust system or the brake system. Make regular checks to ensure that the towing bracket is secure.

Engine cooling system

Driving with a trailer increases the load on the engine and cooling system. The cooling system should have sufficient coolant and be

prepared for the additional effort involved in driving with a trailer.

Trailer brakes

If the trailer has its own brake system, please take the relevant legal requirements into account. Never connect the trailer's brake system to the vehicle's brake system.

Tow cable

Always use a cable between the vehicle and the trailer »» page 244.

Trailer tail lights

The trailer's rear lights should comply with the statutory safety regulations »» page 244.

Never connect the trailer's rear lights directly to the vehicle's electric system. If you are not sure that the trailer's electrical connection is correct, have it checked by a specialised workshop. SEAT recommends visiting a SEAT dealership for this.

Exterior mirrors

If you cannot see the area behind the trailer with the exterior mirrors of the towing vehicle, additional mirrors will have to be installed in accordance with the regulations of the country in question. The exterior mirrors should be adjusted before you start driving and must provide a sufficient field of vision at the rear. »

Trailer maximum electricity consumption

Never exceed the values indicated!

Brake lights (total)	84 Watts
Turn signal (on each side)	42 watts
Side lights (on each side)	50 Watts
Reverse lights (in total)	42 Watts
Rear fog light	42 Watts

⚠ WARNING

If the towing bracket is wrongly fitted or is not the right one, the trailer could become detached from the vehicle and cause serious injury.

ⓘ CAUTION

- If the rear lights of the trailer are not correctly connected, the vehicle's electronic system may be damaged.
- If the trailer absorbs excessive electric current, the vehicle's electronic system may be damaged.
- Never connect the trailer's electric system directly to the electrical connections of the tail lights or any other power sources. Only use the connections intended for providing electric current to the trailer.

Hitching and connecting a trailer

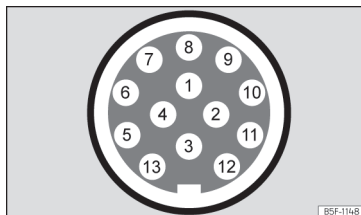


Fig. 168 Schematic representation: assignment of the pins of the trailer's electrical socket.

Pin	Meaning
1	Left turn signal
2	Rear fog light
3	Earth for pins 1, 2, 4, 5, 6, 7 and 8
4	Right turn signal
5	Rear light, right
6	Brake lights
7	Rear light, left
8	Reverse lights
9	Permanent live
10	Live charge cable
11	Earth for pin 10

Pin	Meaning
12	Unassigned
13	Earth for pin 9

Power socket for trailer

The vehicle is fitted with a 13-pole power socket for the connection between the trailer and the vehicle. With the engine running, electrical devices on the trailer receive power from the electrical connection (pin 9 and pin 10 of the trailer power socket).

If the system detects that a trailer has been connected, the consumers on the trailer will receive electricity through this connection (pins 9 and 10). Pin 9 has a permanent live. This powers, for example, the trailer's interior lighting. Electrical devices such as a fridge in a caravan **only** receive electrical power if the engine is running (through pin 10).

To avoid overloading the electrical system, you cannot connect the ground wires of pin 3, pin 11 or pin 13 to each other.

If the trailer has a **7-contact connector**, you will need to use an adapter cable. In this case the function corresponding to pin 10 will not be available.

Tow cable

The tow rope must always be securely fixed to the towing vehicle and loose enough so

that the vehicle can handle turns smoothly. However, make sure that the cable does not rub on the ground while driving.

Trailer tail lights

Always check the trailer's rear lights to ensure they are working correctly and that they comply with the relevant safety regulations. Make sure that the maximum permissible power that can be absorbed by the trailer is not exceeded » page 244.

Include in the anti-theft alarm

The trailer is included in the anti-theft system if the following conditions are met:

- If the vehicle is factory-equipped with an anti-theft alarm and towing bracket.
- If the trailer is electrically connected to the towing vehicle through the trailer power socket.
- If the electrical systems of the vehicle and trailer are in perfect condition and have no faults or damage.
- If the vehicle is locked with the key and the anti-theft alarm is activated.

When the vehicle is locked, the alarm is triggered if the electrical connection with the trailer is cut off.

Before hitching or unhitching a trailer, always turn off the anti-theft alarm. Otherwise, the tilt sensor could cause the alarm to go off.

Trailers with LED tail lights

For technical reasons, trailers fitted with LED rear lights cannot be connected to the anti-theft alarm system.

When the vehicle is locked, the alarm does not go off when the electrical connection with the trailer is cut if it has rear lights with light-emitting diodes.

If the **Eco** driving profile was selected when hitching the trailer, this will automatically switch to the **Normal** profile. If the system cannot detect the attached trailer or if the towing bracket has been retrofitted by an auto repair shop other than SEAT, you must manually select the **Normal** profile before you start driving with a trailer attached. To reconnect the **Eco** profile once the trailer has been unhitched, switch the ignition off and back on once.

WARNING

If the cables are improperly or incorrectly connected, it may lead to an excessive amount of current supplied to the trailer, which can cause abnormalities in the entire vehicle electronic system, as well as accidents and serious injuries.

- Ensure that any repairs that need to be carried out on the electrical system are carried out by a specialised workshop.
- Never connect the trailer's electric system directly to the electrical connections of the tail lights or any other power sources.

WARNING

Contact between the pins of the trailer power socket can cause short circuits, overloading of the electrical system or failure of the lighting system, and consequently can cause accidents and serious injuries.

- Never connect the pins of the trailer power socket to each other.
- Make sure any work on bent pins is carried out by a specialised workshop.

CAUTION

Do not leave the trailer connected to the vehicle when parked; place it on its support wheel or its supports. If the vehicle rises or falls due, for example, to a variation of the load or a burst tyre, increased pressure will be placed on the towing bracket and the trailer, and both the vehicle and the trailer can be damaged.

Note

- In case of anomalies in the electrical systems of the vehicle or trailer, as well as in »

the anti-theft alarm system, have them inspected by a specialised workshop.

- If the trailer accessories consume energy through the power socket to the trailer and the engine is turned off, the battery will discharge.
- If the vehicle battery is running low, the electrical connection with the trailer will be automatically cut.

Trailer loading

Technically permissible maximum trailer weight and vertical load on the coupling device

The technically permissible maximum trailer weight is the weight that the vehicle can tow »» » ⚠. The vertical load on the coupling is exerted vertically from above on the hook of the towing bracket.

The information on the maximum trailer weight and vertical load on the coupling device contained in the type plate of the towing bracket are experimental values only. The correct figures for your specific model, which may be lower than these figures, are given in the vehicle documentation. The information in the vehicle documentation takes precedence at all times.

To promote safety while driving, SEAT recommends making the most of the maximum ver-

tical load technically permissible on the coupling device »» » page 241. An insufficient vertical load has a negative influence on the behaviour of both the vehicle and trailer.

The vertical load increases the weight on the rear axle, reducing the vehicle's carrying capacity.

Gross combination weight of the towing vehicle and trailer

The gross combination weight is the actual weight of the loaded vehicle plus the actual weight of the loaded trailer.

In some countries trailers are classified into distinct categories. SEAT recommends obtaining information from a specialised workshop regarding which type of trailer is most suitable for your vehicle.

Trailer loading

The weight of the towing vehicle and trailer must be balanced. In order to do this, the load must be as close as possible to the maximum vertical load technically permissible on the coupling point, and it must be evenly distributed between the back and front of the trailer:

- Distribute loads in the trailer so that heavy objects are as near to the axle as possible or above it.
- Secure the trailer load properly.

Tyre pressure

Set the tyre pressure of the trailer tyres in accordance with the trailer manufacturer's recommendations.

When towing a trailer, inflate the tyres of the towing vehicle with the maximum allowable pressure »» » page 278.

⚠ WARNING

If the maximum permissible axle weight, the maximum load technically permissible on the coupling point, the maximum authorised vehicle weight or the gross combination weight of the towing vehicle and trailer are exceeded, accidents and serious injuries may occur.

- Never exceed the values indicated!
- The actual weight on the front and rear axles must never exceed the maximum permissible axle weight. The weight on the front and rear axles must never exceed the maximum permissible weight.

⚠ WARNING

A shift in weight could jeopardize the stability and security of the towing vehicle and trailer, which could lead to accidents and serious injuries.

- Always load the trailer correctly.
- Always secure the load properly using belts or straps that are suitable and in good condition.

Driving with a trailer

Adjusting the headlights

The front part of the vehicle may be raised when the trailer is connected and the light may dazzle the rest of the traffic.

Adapt the height of the headlights using the headlight range adjuster » page 120¹⁾.

Specific features of driving with a trailer

- If your trailer has an **overrun brake**, brake *gently at first* and then rapidly. This will prevent the jerking that can be caused by the locking of trailer wheels.
- Due to the gross combination weight of the towing vehicle and trailer, the braking distance increases.
- When going down a slope, go into a lower gear (if using a manual gearbox or the tip-tronic automatic gearbox mode) to take advantage of the braking power provided by the engine. Otherwise, the braking system could overheat and even fail.
- The trailer weight, as well as the gross combination weight of the towing vehicle and trailer, change the centre of gravity and the properties of the vehicle.

- If the towing vehicle is empty and the trailer is loaded, then the load distribution is incorrect. Under these conditions, drive slowly and with extra caution.

Hill starts with a trailer

Depending on the slope of the hill and the combination weight of the towing vehicle and trailer, the vehicle might start rolling backwards slightly when you first start up.

For hill-starting with a trailer, do the following:

- Press and hold the brake pedal.
- If the vehicle is equipped with a manual gearbox, push the clutch pedal all the way down.
- Put the vehicle into first gear or turn the selector lever to position **D/S** » page 198.
- Apply the handbrake.
- Release the brake pedal.
- Start driving slowly. To do this, in the case of a manual gearbox, slowly release the clutch pedal.
- Do not release the hand brake until the engine has sufficient power to start driving

WARNING

If a trailer is pulled incorrectly, this may lead to loss of control of the vehicle and serious injury.

- Driving with a trailer and transporting heavy or large objects will change the vehicle handling and braking distances.
- Always drive cautiously and carefully. Brake earlier than usual.
- Adapt your speed and driving style at all times to suit visibility, weather, road and traffic conditions. Slow down, especially when driving down hills or slopes.
- Accelerate with particular care and caution. Avoid sudden braking and manoeuvres.
- Take great care when overtaking. Reduce speed immediately if you notice that the trailer is swaying, however slightly.
- Never attempt to "straighten" the towing vehicle and trailer while accelerating.
- Take into account the speed limit for vehicles with a trailer, as it could be lower than for vehicles without a trailer.



¹⁾ This does not apply for vehicles with Full LED xenon headlights.

Stabilisation of the towing vehicle and trailer combination

The stabilisation of the vehicle and trailer combination is an additional function of the electronic stability control (ESC).

If the system detects that the trailer is weaving, it intervenes to reduce the swaying of the trailer.

Vehicle and trailer combination stabilisation requirements

- The vehicle is factory-equipped with a towing bracket or has been retro-fitted with a compatible towing bracket.
- The ESC and ASR are active. The control lamp  or  is not lit up on the instrument cluster.
- The trailer is connected to the towing vehicle through the trailer power socket.
- The vehicle is travelling at over 60 km/h (approx. 37 mph).
- The maximum vertical load technically permissible is not being exceeded on the coupling device.
- The trailer has a rigid draw bar.
- If the trailer has brakes, it must be equipped with a mechanical overrun brake.

⚠ WARNING

The enhanced safety provided by the electric stability control of the vehicle and trailer should not lead you to take any risks that could compromise your safety.

- Adapt your speed and driving style at all times to suit visibility, weather, road and traffic conditions.
- Accelerate with caution when the road is slippery.
- When adjusting any settings, stop accelerating.

⚠ WARNING

The electric stability control for the vehicle and trailer may not correctly detect all driving conditions.

- When the ESC is switched off, the stabilisation of the towing vehicle and trailer is also switched off.
- The stability system does not always detect light trailers, so it may not stabilise these correctly.
- When driving on surfaces with poor grip, the trailer can even *interfere* with the stability system.
- Trailers with a high centre of gravity can tip over without having previously weaved.
- If a trailer is not attached, but a connector is plugged into the power socket (e.g. installation of a bicycle rack with lights),

repeated automatic braking may occur in extreme driving conditions.

Towing bracket device*

Description

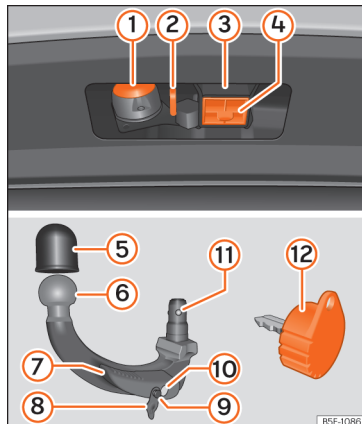


Fig. 169 The towing device supports trailers / tow hook / key

Depending on the country or version, the removable hook of the towing device is under

the cover of the load area of the luggage compartment.

The tow hook is fitted and removed by hand and is supplied with a key.

- ① 13-pin connector
- ② Safety lug
- ③ Hook housing
- ④ Hook housing cap
- ⑤ Protective cap of the ball head
- ⑥ Removable tow hook
- ⑦ Locking lever
- ⑧ Lock cover
- ⑨ Release bolt
- ⑩ Lock
- ⑪ Locking balls
- ⑫ Key

Operation and conservation

Put the cover on the housing cavity so that dirt cannot get in.

Before hooking up a trailer, always check the ball head and apply suitable grease if necessary.

Use the protective cap to store the tow hook.

Clean the housing cavity surfaces and treat them with an appropriate conservation product.

⚠ WARNING

- Before each journey with the tow hook fitted, make sure that it is correctly adjusted and attached in its housing.
- If the tow hook is not properly fitted and attached, do not use it.
- Do not use the towing bracket device for towing if it is damaged or has missing parts.
- Do not modify or adapt the towing device connection.
- Never unhook the tow hook while the trailer is hitched.

ⓘ CAUTION

- Handle the tow hook with care in order to avoid damaging the bumper paintwork.
- The top part of the hook housing is greased » Fig. 169 ③. When using the device, make sure that it has not been removed.

ⓘ Note

- Contact a specialised workshop if you lose your key.
- Towing the vehicle with the tow hook » page 51.

Placing in the standby position

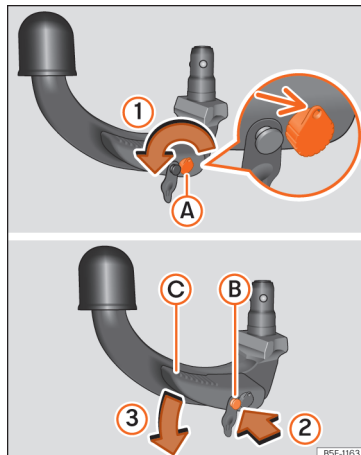


Fig. 170 Tow hook reserve position

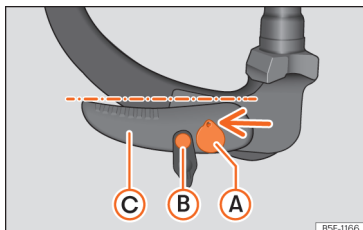


Fig. 171 Reserve position: position verification

Before assembling it, place the tow hook in the standby position with the following two steps.

- Insert and turn the key in the direction of the arrow » **Fig. 170 ①** until the hole in the key faces upwards (arrow).
- Grab the tow hook under the protective cover.
- Press the release bolt » **Fig. 170 B** in the direction of arrow **②**, while pressing lever **C** in the direction of arrow **③** as far as it will go.
- The lever will remain blocked in this position.

Verification of the reserve position

- Key » **Fig. 171 A** is in the released position (the key hole is facing upwards).
- The release bolt » **Fig. 171 B** can be moved.

- Lever » **Fig. 171 C** is in the lower position.

When adjusted in this way, the tow hook is ready to be installed.

⚠ CAUTION

The key cannot be removed or turned in the standby position.

Fitting the tow hook

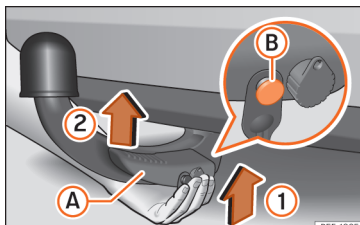


Fig. 172 Putting the tow hook in place. Step 1.

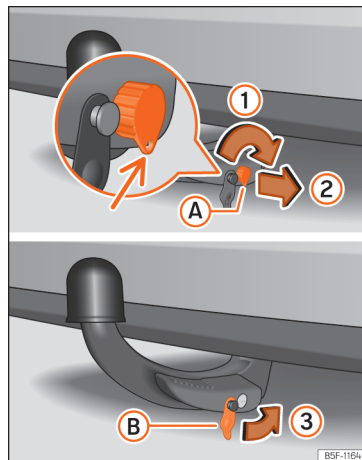


Fig. 173 Putting the tow hook in place. Step 2.

Step 1.

- Remove the hook housing cap » **Fig. 169 ④** downwards.
- Put the tow hook in its standby position » **page 249**.
- Hold the tow hook **from below** and fit it into the hook housing in the direction of the arrow » **Fig. 172 ①** until it is heard to fit into place » **△**.

Lever »» Fig. 172 (A) automatically turns in the direction of arrow (2) upwards, and the release bolt (B) moves outwards (its red and green parts are visible) »» ⚠.

If lever (A) does not turn or the release bolt (B) does not come out, the tow hook should be removed by turning the lever as far as possible downwards from the housing cavity, and the tow hook's support surfaces and the cavity should then be cleaned.

Step 2.

- Turn the key to the right just half a turn, until the hole in the key faces downwards »» Fig. 173 (1).
- Remove the key (2).
- Place the cover (B) on the lock (3) »» Fig. 173 »» ⚠.
- Check that the tow hook is correctly fixed in place »» page 251, Safety check.

⚠ WARNING

- Keep your hands away from the lever when fitting the tow hook to avoid trapping your fingers »» Fig. 172 (A).
- Do not try to force the lever up to turn the key. The detachable ball would not be secured properly!

⚠ CAUTION

- After removing the key, place the cover over the lever's lock. If the lock becomes soiled it will be impossible to insert the key.
- Keep the device's housing clean. Dirtiness can prevent the tow hook from being safety secured!
- If the device is removed, always place the cap in the hook's housing.

Safety check

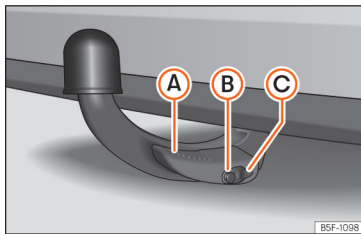


Fig. 174 Tow hook fixed correctly

Make sure that the tow hook is correctly attached before each use.

Tow hook fixed correctly:

- The tow hook will not fall out of the housing cavity after a strong "impact".
- Lever (A) is facing upwards »» Fig. 174.

- The red and green part of the unlocking bolt (B) is completely visible »» Fig. 174.
- The key has been removed.
- Cover (C) is over the lock »» Fig. 174.

⚠ WARNING

- Keep your hands away from the lever when releasing the tow hook to avoid trapping your fingers »» Fig. 174 (A).
- The towing device should only be used if the tow hook has been properly locked in place!

Removing the tow hook

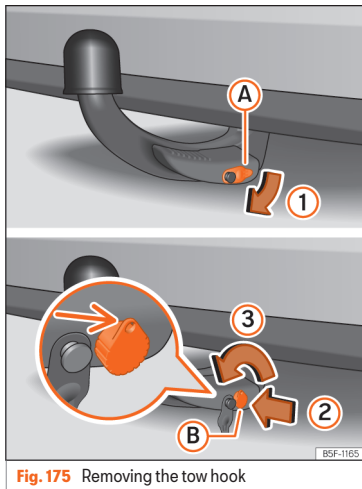


Fig. 175 Removing the tow hook

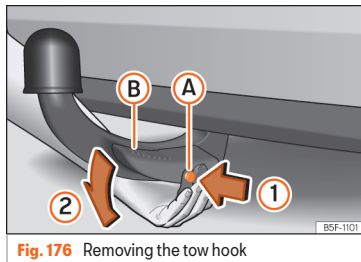


Fig. 176 Removing the tow hook

- Remove cover (A) from lock (1) »»» Fig. 175.
- Insert key (B) in the lock (2) »»» Fig. 175.
- Turn the key to the left (3) just half turn, until the hole in the key is facing upwards »»» Fig. 175.
- Hold the tow hook from below.
- Press the release bolt (A) in the direction of arrow (1), and at the same time press lever (B) as far as it will go in the direction of arrow (2) »»» Fig. 176.

Now the tow hook has been released and falls freely. If this does not occur, press with the other hand from above.

The tow hook is now in the standby position and is therefore ready to be reinserted into the hook housing »»» ①.

- Fit cover (4) »»» Fig. 169 onto its housing.

⚠ WARNING

- Never remove the tow hook while the trailer is hitched.
- Never leave the tow hook loose in the luggage compartment. It could cause damage in the event of sharp braking, and even jeopardise passenger safety!

ⓘ CAUTION

- If the lever is not pressed down as far as it will go, after removing the tow hook it will continue upwards and will not lock into its standby position. The tow hook must remain in this position before being fitted again.
- Store the device in the reserve position with the key inserted and with the same side facing upwards. Risk of damaging the key!
- When operating the lever, do not apply too much pressure (for example, do not stand on it)!

ⓘ Note

- Before extracting the tow hook, we recommend fitting the protective cover over the ball head.
- Remove dirt from the tow hook before storing it with the vehicle tools.

Connecting the trailer

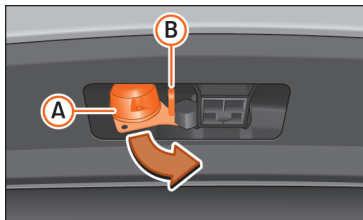


Fig. 177 Turning the 13-pin connector

- Grip the connector in area **A** and remove it in the direction of the arrow »» Fig. 177.
- Remove the protective cap from the ball head »» Fig. 169 **5**.
- Attach the trailer to the ball head.
- Open the cover of connector **A** and connect the trailer »» Fig. 177.
- Hook the trailer retention cable into the safety eyelet »» Fig. 177 **B**. When hooked, the retaining cable must **curve** in all trailer positions in front of the vehicle (sharp curves, reverse, etc.).

Follow these steps in reverse to unhitch the trailer.

⚠ WARNING

- Never use the safety lug to tow!

- After hooking up the trailer and connecting the socket, check that all the trailer's rear lights are working properly.

i Note

- If there is any fault in the trailer's lighting, check the fuses on the instrument panel »» page 55.
- The contact between the retainer cable and the safety lug may give cause wear in the lug. This wear does not stop it from operating properly and is not a fault. It is excluded from the warranty.
- When hitching and unhitching the trailer, the vehicle's handbrake should be applied.

Retrofitting a towing bracket

Description

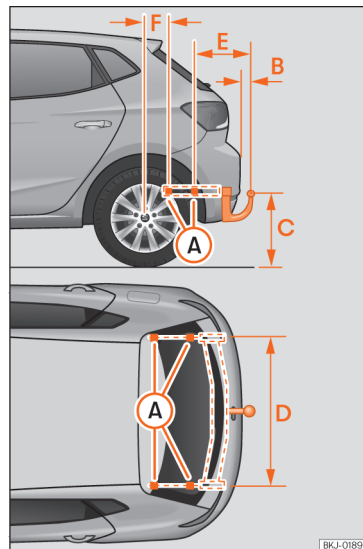









Fig. 178 Limits and attachment points for retrofitting a towing bracket.

SEAT recommends that towing brackets be retrofitted at a specialised workshop. For example, it may very well be necessary to adjust the cooling system or mount thermal protection plates. SEAT recommends visiting a SEAT dealership for this.

If a towing bracket is retrofitted, the distance specifications should always be kept in mind.

The distance between the centre of the ball head and the road »» Fig. 178  must never be less than that indicated. This also applies when the vehicle is fully loaded, including the technically permissible maximum vertical load on the coupling device.

Distance specifications »» Fig. 178:

-  Attachment points (lower part of the vehicle)
-  65 mm (minimum)
-  350 mm to 420 mm (fully laden vehicle)
-  1,033 mm
-  322 mm
-  338 mm

WARNING

If the cables are improperly or incorrectly connected, this may lead to malfunctions in the entire vehicle electronic system, as well as to accidents and serious injuries.

- Never connect the trailer's electric system to the electrical connections of the tail

lights or any other unsuitable power sources. Only use suitable connectors to connect the trailer.

- The towing bracket should be retrofitted only at a specialised workshop.

WARNING

If the towing bracket is badly fitted or unsuitable, the trailer may separate from the vehicle while driving. This could cause serious accidents and fatal injuries.

Note

- Only use towing brackets that have been approved by SEAT for the model in question.
- In some versions, the fitting of a conventional towing hook solution is not recommended. Please consult your Technical Service.

Practical tips

Checking and refilling levels

Refuelling

Refuelling

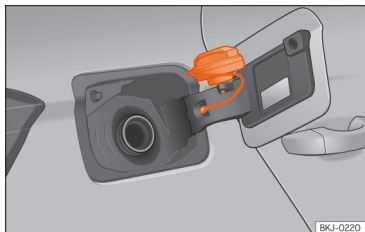


Fig. 179 Fuel tank flap with tank cap attached.

The fuel tank flap is on the rear right of the vehicle.

The flap that covers the tank cap is unlocked and locked automatically using the central locking.


- Open the fuel tank flap by pressing on the left side.
- Unscrew the cap by turning it to the left.

- Place it in the space on the hinge of the open flap »» Fig. 179.
- Start refuelling. The tank is full as soon as the pump's automatic nozzle cuts off the fuel supply. Do not try to put in more fuel after the nozzle cuts out, as this will fill the expansion chamber in the fuel tank.
- Unscrew the cap by turning it to the right as far as it will go.
- Close the lid.

The correct fuel grade for your vehicle is given on a sticker on the inside of the fuel tank flap. Further notes on fuel can be found at »» page 257.

The capacity of your vehicle's fuel tank is given in »» page 302.

Vehicles with natural gas engines and hybrids

Every 6 months it is necessary to run on petrol until the control lamp  switches off, and then the tank must be refilled. This is necessary to ensure that the system works properly, as well as the fuel quality required for driving with petrol.

WARNING

Fuel is highly flammable and can cause serious burns and other injuries.

- When refuelling, turn off the engine and turn off the ignition for safety reasons.

- Do not smoke when filling the fuel tank or a canister. Naked flames are forbidden in the vicinity due to the risk of explosion.
- Observe legislation governing the use, storage and carrying of a spare fuel canister in the vehicle.
- For safety reasons we do not recommend carrying a spare fuel canister in the vehicle. In an accident the canister could be damaged and could leak.
- If, in exceptional circumstances, you have to carry a spare fuel canister, please observe the following points:

- Never fill fuel into the spare fuel canister if it is inside or on top of the vehicle. This could cause an explosion. Always place the canister on the ground to fill it.
- Insert the filling nozzle as far as possible into the spare fuel canister.
- If the spare fuel canister is made of metal, the filling nozzle must be in contact with the canister during filling. This helps prevent an electrostatic charge building up.
- Never spill fuel in the vehicle or in the luggage compartment. Fuel vapour is explosive. Risk of fatal accident!

»

ⓘ CAUTION

- If any fuel is spilled onto the vehicle, it should be removed immediately. It could otherwise damage the paintwork.
- Never run the tank completely dry. The catalytic converter can be damaged.
- When filling the fuel tank after having run it completely dry on a vehicle with a diesel engine, the ignition must be switched on for at least 30 seconds before starting the engine. When you then start the engine it may take longer than normal (up to one minute) to start firing.

🌿 For the sake of the environment

Do not overfill the fuel tank, it may cause the fuel to overflow if it becomes warm.

ⓘ Note

There is no emergency mechanism for the manual release of the fuel tank flap. If necessary, request assistance from specialised personnel.

ⓘ Note

Diesel vehicles are fitted with a protective device that prevents the insertion of the wrong fuel hose¹⁾. It is only possible to refuel with Diesel nozzles.

- If the pump nozzle is worn, damaged, or if it is very small, it is possible that it will not be able to open the protective device. Before trying to insert the pump nozzle by turning it, try a different pump or request specialist help.
- If you fill the tank from a reserve fuel canister, the protective device will not open. One way to resolve this is to pour the fuel in very slowly.

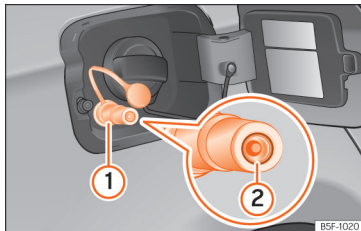
Refuelling natural gas

Fig. 180 Tank cap open: gas filler mouth (1), filler mouth retainer (2).

Before refuelling, the engine and the ignition, mobile telephone and heating must be switched off separately >>> ⚠.

Read the instructions on how to use the natural gas pump carefully.

Refuelling

The natural gas filler mouth is behind the fuel tank cap, next to the petrol filler mouth

>>> **Fig. 180.**

- Remove the plug from the gas filler mouth (1).
- Connect the pump filling nozzle to the gas filler mouth.
- The fuel tank will be *full* when the pump compressor automatically cuts the supply.
- If you wish to finish refuelling in advance, press the button on the pump to stop the flow.

If the ambient temperature is very high, the natural gas pump's overheating protection disconnects it automatically.

Closing the fuel tank cap

- Check that the mouth retainer (2) of the gas filler is not trapped with the filler. If this happens, replace it in the filler mouth.
- Insert the plug in the filler mouth.
- Close the tank flap. Make sure you hear it click into place.

¹⁾ Depending on country

⚠ WARNING

Natural gas is a highly explosive, easily flammable substance. Incorrect handling of the natural gas can cause accidents serious burns and other injuries.

- Before refuelling with natural gas, engage the filling mouth correctly. If you can smell gas, stop refuelling immediately.
- Read and take note »» ⚠ in Natural gas on page 260.

⚠ WARNING

The vehicle is not suitable for liquefied natural gas (LNG) or liquefied petrol gas (LPG), so LNG or LPG should not be used under any circumstances. Liquid gas can cause an explosion of the natural gas tanks and cause severe injuries!

⚠ WARNING

If the vehicle underbody touches the ground or in the event of a rear collision, there could be damage to the natural gas tanks. If damaged, natural gas tanks are full of fuel and can explode, causing serious or fatal injuries.

- Even if you don't notice the smell of gas, take the vehicle to a specialised workshop immediately and have the natural gas system checked. Do not refuel natural gas

again until the natural gas system has been inspected.

📄 Note

- The filling nozzles of natural gas pumps can differ in the way they are operated. Ask a qualified employee at the petrol station to do the refuelling if you do not know how.
- Noises heard when refuelling are normal and do not indicate damage in the system.
- The vehicle natural gas system is prepared both for refuelling with a small compressor (slow refuel) and a large compressor (fast refuel) at natural gas service stations.

Fuel types

Identification of fuels¹⁾

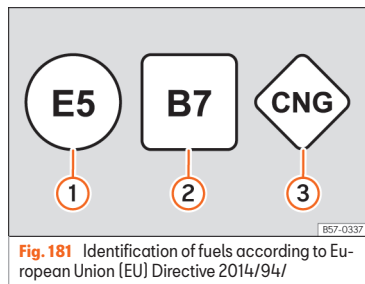


Fig. 181 Identification of fuels according to European Union (EU) Directive 2014/94/

Fuels are identified by different symbols on the pump and on your vehicle's tank flap. The identification serves to prevent confusion when choosing the fuel.

- 1) **Petrol** with ethanol ("E" stands for **E**thanol). The number indicates the percentage of ethanol in the petrol. "E5" means, for example, an ethanol ratio of 5% max.
- 2) **Diesel** with biodiesel ("B" stands for **B**iodiesel). The number indicates the percentage of biodiesel in the diesel. "B7" means, for example, a proportion of biodiesel of max. 7%.

»

¹⁾ Depending on country

- ③ **Natural gas:** "CNG" means **C**ompressed **N**atural **G**as.

Type of petrol

✓ Valid for: vehicles with petrol engines

The correct grade of petrol is listed inside the fuel tank flap.

The vehicle is equipped with a catalytic converter and must only be run on **unleaded petrol**. The petrol must comply with the standard EN 228 and be **sulphur-free**. Fuels with a 10% ethanol ratio can be refuelled (E10)¹⁾. The types of petrol are differentiated by using the **octane numbers (RON)** or via the **anti-knock index (AKI)**.

Super unleaded petrol 95 octane petrol or normal 91 octane petrol at least

We recommend refuelling with super 95 octane petrol (91 AKI). If not available, normal 91 octane petrol (87 AKI) (with a slight power loss) may be used.

Super unleaded petrol, 95 octanes at least

You should use super 95 octane petrol (91 AKI) at least.

If super is not available, *if necessary*, use normal 91 octane petrol (87 AKI). In this case only use moderate engine speeds and a light throttle. Refuel with super as soon as possible.

Unleaded super plus 98 octane petrol or super 95 octane petrol at least

We recommend refuelling with super plus 98 octane petrol (93 AKI). If not available: super 95 octane petrol (91 AKI) (with a slight power loss).

If super is not available, *if necessary*, use normal 91 octane petrol (87 AKI). In this case only use moderate engine speeds and a light throttle. Refuel with super as soon as possible.

ⓘ CAUTION

- Fuels high percentage of ethanol, e.g. E30 - E100 button must not be used. The fuel system would be damaged. Exception: vehicles with Totalflex engine »» page 259, Ethanol fuel.
- A single refuelling with leaded fuel or other metal additives entails a permanent deterioration of the effectiveness of the catalytic converter.

- Only use fuel additives that have been approved by SEAT. The products that contain substances to increase the octane rating or decrease knocking may contain metal additives that damage the engine and catalytic converter. This type of products must not be used.
- Do not use fuels shown in the pump as containing metals. LRP (*lead replacement petrol*) fuels contain high concentrations of metal additives. Risk of engine damage!
- High engine speed and full throttle can damage the engine when using petrol with an octane rating lower than the correct grade for the engine.

ⓘ Note

- Fuel with an octane rating higher than the one required by the engine can be used.
- In countries in which there is no sulphur-free fuel, it is also allowed to use low sulphur content fuel.

¹⁾ Follow the regulations of the country you are driving in.

Ethanol fuel

✓ Valid for: vehicles with Totalflex engines

You can recognise vehicles with Totalflex engines¹⁾ by label on the fuel tank lid with with the marking "Petrol/ethanol".

Vehicles with Totalflex engine can run with unleaded petrol (95 octane / 91 AKI) according to ANP No. 57 and with fuels with any high percentage of ethanol. The vehicle is refueled in the same way as petrol refuelling.

Also consider that » page 258, Type of petrol

Note

SEAT recommends filling the tank exclusively with petrol every 10,000 km to decrease impurities that using E100 ethanol fuel might have left in the engine.

Diesel

✓ Valid for: vehicles with diesel engines

Please note the information on the inside of the fuel tank flap.


We recommend you use **Diesel** according to standard EN 590.

¹⁾ This motor is only available in some markets.

²⁾ Depending upon country.

The diesel can thicken at very low temperatures, thus affecting the start or operation of the engine. Ask your service station attendant if their diesel is suitable for winter use.

Water in the fuel filter²⁾

If your vehicle has a diesel engine and is equipped with a **fuel filter with a water separator**, the instrument panel may display the following warning:  **Water in the fuel filter**. If this is the case, take the vehicle to a specialised workshop so that they can drain the fuel filter.

CAUTION

- Never use of FAME (biodiesel), petrol, heating oil, other fuels or thinning agents as they can cause severely damage the fuel system and the engine.
- If the wrong fuel has been filled, do not start the engine under any circumstances. Risk of damaging the fuel system and the engine! Obtain technical assistance.

Natural gas

✓ Valid for: vehicles with natural gas engines

Natural gas can be compressed or in liquid form, addition to others.

Use of compressed natural gas (CNG)

Vehicles with a natural gas engine must only be working with **CNG** (Compressed Natural Gas **CNG**), or with a mixture of **biomethane** if it complies with Regulation EN 16723-2.

Fuels such as liquefied natural gas (LNG), liquefied petroleum gas (LPG) or hithane (mixture of hydrogen and methane) should not be used to fill the tank.

Natural gas quality and consumption

Natural gas is divided into the groups H and L depending on its quality.

Gas type H has a superior heating power and inferior nitrogen and carbon dioxide content than type L. The higher the heating power of the natural gas, the lower the consumption will be.

The engine management automatically adapts to the natural gas used according to its quality. Therefore, different quality gases can be mixed in the tank, without the need for »

comprehensive draining before applying a different quality gas.

Updated information relating to natural gas quality is displayed on the instrument panel
»» page 74.

Regular checks of the natural gas system

The natural gas tanks may be damaged or corroded by external factors. The walls of the gas tanks are weakened by deformations, damage or corrosion. The vehicle owner must have a specialised workshop check (visual check) **the gas system at least once every 4 years**. Natural gas tanks must be replaced at a specialised workshop.

WARNING

Failure to act when you can smell gas in the vehicle or when refuelling can cause serious injuries.

- Stop the vehicle immediately.
- Switch the ignition off.
- Open the doors to appropriately ventilate the vehicle.
- Extinguish cigarettes immediately.
- Move away from the vehicle or switch off objects that may cause sparks or a fire.
- If you continue to smell gas, do not continue driving!
- Seek specialist assistance. Have the fault repaired.

- If necessary, warn the emergency services.

WARNING

Damaged, corroded or rusted tanks can result in serious injury or even death.

- Have the natural gas deposits checked at least every 4 years (visual check).
- Natural gas tanks have a limited service life. Have the natural gas tanks replaced when required. You can obtain further information about this at SEAT dealers or specialised workshops.

AdBlue®


Information about AdBlue®


AdBlue® consumption depends on your personal driving style, the temperature of the system and the outdoor temperature when the vehicle is used.

AdBlue® freezes at temperatures of -11 °C (+13°F). The system has heating elements that guarantee its operation even at low temperatures.

The AdBlue® tank has a capacity of approx. 10.4 litres.

When the **range is less than 2400 km** the instrument cluster screen displays a message requesting an AdBlue® refill.

If this message is ignored, the yellow warning lamp will come on when the **remaining range is less than 1000 km**. . The indication that in XXX km it will no longer be possible to restart the engine will appear on the instrument panel display.

If the yellow indicator lamp is ignored, when **remaining range of 0 km** is displayed, it will no longer be possible to restart the engine. The red warning lamp will light up .

AdBlue® is a registered trademark of the German Association of the Automotive Industry (VDA) and is also known as AUS32 or DEF (Diesel Exhaust Fluid).

CAUTION

Overfilling with AdBlue® can cause damage to the tank system.

Control and warning lamps



It lights up red

The engine cannot be restarted! The AdBlue level is too low. Stop the vehicle in a suitable, safe and flat area then top up with the minimum required quantity of AdBlue
»» page 261.

and They light up red

The engine cannot be restarted! Fault in the AdBlue system.
Contact a specialised workshop. Have the system checked there.

It lights up yellow


The AdBlue reserve is low.
Refill AdBlue within the next kilometres (or miles) that are indicated »» page 261. SEAT recommends contacting a specialised workshop.

and They light up yellow

There is a fault in the AdBlue system or unsuitable AdBlue fluid has been used.
Contact a specialised workshop. Have the system checked there.

Several warning and control lamps should light up for a few seconds when the ignition is switched on, signalling that the function is being verified. They will switch off after a few seconds.

WARNING

Observe the safety warnings »»  in Control and warning lamps on page 85.

Fill AdBlue®

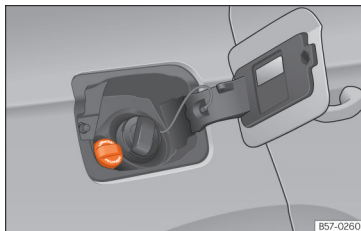


Fig. 182 AdBlue tank cap.


Operations prior to refilling

Park the vehicle on a flat surface and turn off the ignition. If the vehicle is on a slope or on a curb, the level indicator may not detect the refill properly.

If an AdBlue® warning message is shown on the instrument cluster display, **fill with at least the minimum required amount (approx. 5 litres)**. Only after adding this amount will the system detect that AdBlue® has been added and you will be able to start the engine again. The maximum amount that can be refilled is 11 litres.

Fill with a refill bottle

Only use AdBlue® that complies with the ISO 22241-1 standard. Only use original containers.

- Open the tank cover »» **Fig. 182**.
- Unscrew the tank cap by turning it in an anti-clockwise direction.
- Please observe the manufacturer's instructions, indicated on the refill bottle.
- Check the expiry date.
- Remove the cap of the refill bottle.
- Insert the neck of the bottle in the tank filler neck vertically and screw the bottle on by hand, by turning it in a clockwise direction.
- Press the refill bottle in the direction of the filler neck and hold it in this position.
- Wait until the contents of the refill bottle have been poured into the AdBlue® tank. Do not compress or break the bottle!
- Turn the bottle in a counter-clockwise direction and gently pull it upwards »» .
- The AdBlue® tank is full when no more liquid comes out of the bottle.
- Screw on the tank cap in a clockwise direction until it is tightly closed.
- Close the fuel tank flap.

Operations before driving

- After refilling the tank, **only** switch on the ignition.
- Leave the ignition on for at least 30 seconds for the system to detect the fluid load.
- Make sure you wait for at least 30 seconds before starting the engine!

»

Refilling the dispenser with AdBlue

Valid for vehicles with selective catalytic reduction.

- Open the tank cap.
- Turn the SCR tank cap anti-clockwise »» Fig. 18Z.
- Add AdBlue until the nozzle stops for the first time.
- Close the SCR tube by turning it clockwise until you hear a click.

WARNING

AdBlue® should only be stored in its original container, which should be tightly closed and kept in a safe place.

CAUTION

- When refilling, the nozzle grip should be aligned downward. Otherwise the nozzle will not connect automatically.
- Do not try to add any more additive after the nozzle has stopped for the first time. The AdBlue tank could overflow and AdBlue could spill out.
- Only use AdBlue® that complies with the ISO 22241-1 standard. Only use original containers.
- Never mix AdBlue® with water, fuel or additives. Any type of damage caused by such a mixture will not be covered by the warranty.

- Never pour AdBlue® into the fuel tank! This could result in engine damage.
- Do not carry the refill bottle inside the vehicle. If there is a leak (due to temperature changes or damage to the bottle), the AdBlue® may damage the vehicle's interior.

For the sake of the environment

Dispose of the refill bottle in an environment-friendly manner.

Note

Suitable AdBlue® refill bottles can be purchased from SEAT dealerships.

Engine management and emissions control system

Introduction

WARNING

- Due to the high temperatures reached by the exhaust gas scrubbing system, you should not park your vehicle near a surface that can catch fire easily. Fire hazard!
- Do not apply wax underneath the vehicle around the area of the exhaust system: Fire hazard!

Control lamps

It lights up

Fault in the emission control system. Reduce speed and drive carefully to the nearest specialised workshop to have the engine checked.

Flashes

Combustion failures that can damage the catalytic converter. Reduce speed and drive carefully to the nearest specialised workshop to have the engine checked.

It lights up

Particulate filter blocked »» page 263.

It lights up

Fault in the petrol engine management. Have the engine checked as soon as possible by a specialised workshop.

When the ignition is switched on, the **EPC** (Electronic Power Control) lights up and should go off once the engine has started.




It lights up

Diesel engine preheating system. The engine can be started straight away when the lamp switches off.

Flashes

Fault in the diesel engine management.
Have the engine checked as soon as possible by a specialised workshop.


Note

While the control lamps , , **EPC** or  are on, there might be faults in the engine, fuel consumption may go up and the engine might lose power.

Catalytic converter

To maintain the useful life of the catalytic converter

- Only use unleaded petrol with petrol engines.
- Never run the fuel tank dry.
- When changing or adding engine oil, do not exceed the necessary amount **» page 268, Topping up the engine oil.**
- Never tow the vehicle to start it, use jump leads if necessary **» page 49.**

If you should notice misfiring, uneven running or loss of power when the car is moving, have the vehicle inspected by a specialised workshop. In general, the emissions warning lamp  will light up when any of these symptoms occur. If this happens, any unburnt fuel can enter the exhaust system and escape into the

atmosphere. The catalytic converter can also be damaged by overheating.

CAUTION


Never run the fuel tank completely dry because an irregular fuel supply can cause ignition faults. This allows unburnt fuel to enter the exhaust system, which could cause overheating and damage the catalytic converter.

For the sake of the environment

Even when the emission control system is working perfectly, there may be a smell of sulphur from the gases on occasions. This depends on the sulphur content of the fuel used. This can quite often be avoided by changing to another brand of fuel.

Particulate filter


✓ Valid for: vehicles with petrol or diesel particulate filters

The particulate filter eliminates most of the soot from the exhaust gas system. Under normal driving conditions the filter cleans itself. If the filter does not clean itself (e.g. if short journeys are made continuously), it becomes blocked with soot and the following indication is displayed to the driver:  **Particulate filter: cleaned while the vehi-**

cle is moving. See Manual. The particulate filter needs cleaning (regeneration).

Regeneration of the petrol and diesel particulate filter

Requirements for the regeneration journey: the engine is at operating temperature.

- Drive at a speed of between 50-120 km/h (31-75 mph). This increases the temperature and burns the soot in the filter **» .**
- Consider the legal speed limits as well as the recommended gears.
- End the regeneration journey once the control warning lamp has gone out.

If the warning lamp stays on after 30 minutes of running in regeneration mode, have a specialised workshop repair the fault

WARNING

Always adjust your speed to suit the weather conditions, roads, braking distance and traffic if the particulate filter is in its regeneration phase. Route recommendations should never make you disregard each country's specific traffic regulations.

CAUTION

• When the exhaust system detects that the particulate filter is close to saturation, the self-cleaning function of this system **»**

recommends optimal driving for this function.


- Due to the high temperatures caused by the regeneration of the particulate filter, it is possible that the radiator fan will activate after stopping the engine, even if its operating temperature has not been reached.
- Noise, smells and high idle speeds can occur during regeneration.
- Always use the correct engine oil and the correct fuel to make sure the useful life of the particulate filter is not affected. Also avoid making short trips all the time.

Engine compartment

Working in the engine compartment

Always be aware of the danger of injury and scalding as well as the risk of accident or fire when working in the engine compartment (e.g. when checking and refilling fluids).

Always observe the warnings listed below and follow all general safety precautions.

The vehicle's engine compartment is a potentially hazardous area »» » .

WARNING

When work is done in the engine compartment, injuries, burns, accidents and even fires can occur.

- Switch the engine off, remove the key from the ignition and apply the electronic parking brake. If the vehicle has a manual gearbox, place the lever in neutral; if it has an automatic gearbox, place the selector lever in position P. Wait for the engine to cool down.
- Never open the bonnet if you see steam or drips of coolant being released from the engine compartment. Wait until no steam or coolant can be seen before opening the bonnet.
- Keep children away from the engine compartment.
- Never spill liquids used for vehicle operation on the engine compartment, as these may catch fire (e.g. the antifreeze in coolant).
- Avoid causing short-circuits in the electrical system, particularly at the points where the jump leads are attached »» » page 49. The battery could explode.
- If working inside the engine compartment, remember that, even when the ignition is switched off, the radiator fan may start up automatically, and therefore there is a risk of injury.

- Never cover the engine with additional insulating materials such as a blanket. Risk of fire!
- Do not unscrew the cap on the coolant expansion tank when the engine is hot. The cooling system is under pressure.
- Protect face, hands and arms by covering the cap with a large, thick rag to protect against escaping coolant and steam.
- Always make sure you have not left any objects, such as cleaning cloths or tools, in the engine compartment.
- If you have to work underneath the vehicle, you must use suitable stands additionally to support the vehicle, there is a risk of accident! A hydraulic jack is insufficient for securing the vehicle and there is a risk of injury.
- If any work has to be performed when the engine is started or with the engine running, there is an additional, potentially fatal, safety risk from the rotating parts, such as the drive belts, alternator, radiator fan, etc., and from the high-voltage ignition system. You should also observe the following:
 - Never touch the electrical wiring of the ignition system.
 - Ensure that jewellery, loose clothing and long hair do not get trapped in rotating engine parts. Danger of death. Before starting any work remove jewellery, tie back and cover hair, and wear tight-fitting clothes.

- Never accelerate with a gear engaged without taking the necessary precautions. The vehicle could move, even if the handbrake is applied. Danger of death.
- Observe the following additional warnings if work on the fuel system or the electrical system is necessary:
 - Always disconnect the battery from the on-board network.
 - Do not smoke.
 - Never work near naked flames.
 - Always keep an approved fire extinguisher immediately available.

For the sake of the environment

- Inspect the ground underneath your vehicle regularly so that any leaks are detected at an early stage. If you find spots of oil or other fluids in the area where it was parked, have your vehicle inspected at the workshop.
- Service fluids leaks are harmful to the environment. For this reason you should make regular checks on the ground underneath your vehicle. If you find spots of oil or other fluids, have your vehicle inspected in a specialised workshop.

Opening and closing the bonnet

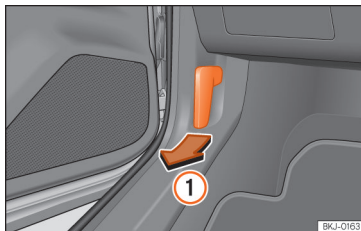


Fig. 183 Release lever in the driver's footwell area.

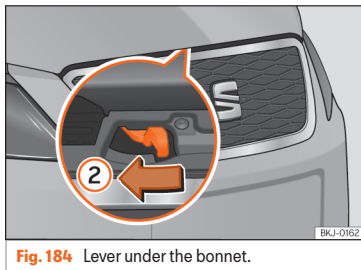


Fig. 184 Lever under the bonnet.

Opening the bonnet

The bonnet is released from inside the vehicle.

Before opening the bonnet, make sure that the windscreen wiper arms are in place against the windscreen.

- Open the door and pull the lever under the dashboard »» Fig. 183 ①.
- To lift the bonnet, press towards the left on the lever located under the bonnet, in the centre »» Fig. 184 ②. The arrester hooks are released.
- The bonnet can be opened. Release the bonnet stay and secure it in the fixture designed for this in the bonnet.

Closing the bonnet

- Slightly lift the bonnet.
- Release the bonnet stay and replace it in its support.
- At a height of approximately 30 cm let it fall so it locks.

If the bonnet does not close, do not press downwards. Open it again and let it fall as mentioned above.

WARNING

Make sure that the bonnet is properly closed. If it opens when driving, it can cause an accident.

CAUTION

To avoid damage to the bonnet and to the windscreen wiper arms, only open it when the windscreen wipers are in place against the windscreen.

Checking levels

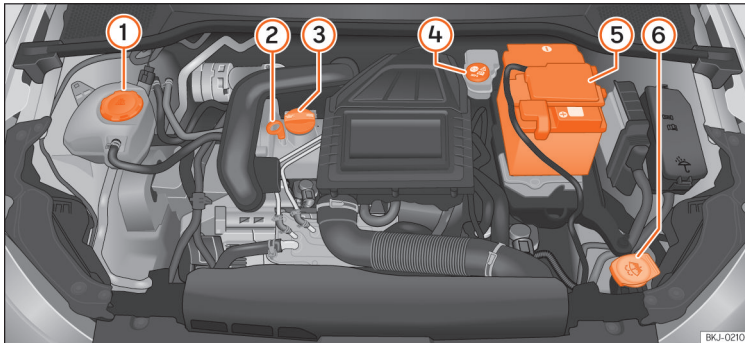


Fig. 185 Diagram for the location of the various elements.

From time to time, the levels of the different fluids in the vehicle must be checked. Never fill with incorrect fluids, otherwise serious damage to the engine may be caused.

- ① Coolant expansion tank »» page 269
- ② Engine oil level dipstick »» page 268
- ③ Engine oil filler cap »» page 268
- ④ Brake fluid reservoir »» page 271
- ⑤ Battery »» page 273
- ⑥ Windscreen washer reservoir »» page 272

Note

The layout of parts may vary depending on the engine.

Engine oil

General notes

The engine comes with a special, multi-grade oil that can be used all year round.

Because the use of high-quality oil is essential for the correct operation of the engine and its long useful life, when topping up or

changing oil, use only those oils that comply with VW standards.

We recommend that the oil change be done by a technical service or specialised workshop.

If the engine oil level is too low

You can get information about the correct engine oil for your vehicle at your workshop.

If the recommended engine oil is not available, in the event of an **emergency** you can change the oil **once** with a maximum of 0,5 L of the next oil until the next oil change:

- *Petrol engines:* standard VW 504 00, VW 502 00, VW 508 00, ACEA C3 or API SN.
- *Diesel engines:* standard VW 507 00, VW 505 01, ACEA C3 or API CK-4.

Have the oil changed by a specialised workshop.

Using engine oil that is compliant with the VW 504 00 standard instead of VW 508 00 could increase consumption and the vehicle's CO₂ emissions.

SEAT recommends using original SEAT oil to guarantee high SEAT engine performance.

Engine oil additives

No type of additive should be mixed with the engine oil. The deterioration caused by these additives is not covered by the warranty.

ⓘ CAUTION

Take the following into account if you have refilled with an engine oil different to those specified in the aforementioned standards, or by your SEAT technical service centre:

- There is no way of completely avoiding the danger of causing damage to the engine and particulate filter*.
- You can continue driving with the vehicle if the refill was no more than 0.5 l of engine oil. Go to a specialised workshop as soon as possible and request an oil change. Other-

wise, there is a danger of engine damage.

- If you have topped up more than 0.5 l of engine oil, drive with the engine at low load levels and within the medium RPM range as a maximum. Do not drive at more than 80 km/h and do not travel more than 300 km (approximately). Go to a specialised workshop as soon as possible and request an oil change. Otherwise, there is a danger of engine damage.

- You are responsible for the risk of possible damage to the vehicle (engine, exhaust system). If in doubt, do not start the engine and request assistance from the technical service centre.


- Do not start the engine if you have topped up with a fluid other than engine oil. Request assistance from the technical service centre. Danger of engine damage!

ⓘ Note


Before a long trip, we recommend finding an engine oil that conforms to the corresponding VW specifications and recommend keeping it in the vehicle. This way, the correct engine oil will always be available for a top-up if needed.

Warning lamp

It lights up red

 **Do not carry on driving!**
Engine oil pressure too low.
Switch off the engine. Check the engine oil level.

If this warning lamp  starts to flash, and is accompanied by three **audible warnings**, switch off the engine and check the oil level. If necessary, add more oil »» page 268.

If the warning lamp  flashes although the oil level is correct, *stop driving*. Do not even run the engine at idle speed! Obtain technical assistance.


It lights up yellow

Check the engine oil level as soon as possible. Replace oil as soon as you have the opportunity to do so »» page 268.

It flashes yellow

Fault in the oil level sensor.
Have the check done by a specialised workshop. Until then it is advisable to check the oil level every time you refuel.

WARNING

Observe the safety warnings »»  in Control and warning lamps on page 85.

Checking the engine oil level

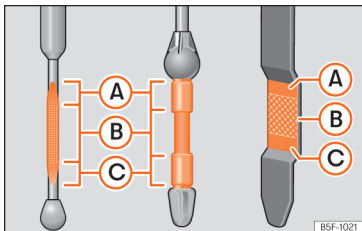


Fig. 186 Engine oil dipstick.

The engine oil dipstick indicates the level of the oil.

Checking oil level

- Park the vehicle in a horizontal position.
- Briefly run the engine at idle speed until the operating temperature is reached and then stop.
- Wait for about two minutes.
- Pull out the dipstick. Wipe the dipstick with a clean cloth and insert it again, pushing it in as far as it will go.
- Then pull it out once more and check the oil level »» **Fig. 186**. Top up with engine oil if necessary.

The oil must leave a mark between zones **A** and **C**. It can never go above zone **A**.

- Zone **A**: do not add oil.
- Zone **B**: you can add oil but keep the level in that zone.
- Zone **C**: add oil until zone **B**.

Depending on how you drive and the conditions in which the vehicle is used, oil consumption can be up to 0.5 l/1000 km. Oil consumption is likely to be higher for the first 5,000 km. For this reason the engine oil level must be checked at regular intervals, preferably when filling the tank and before a journey.

⚠ WARNING

Any work carried out in the engine compartment or on the engine must be carried out cautiously.

- When working in the engine compartment, always observe the safety warnings »» page 264.

ⓘ CAUTION

If the oil level is above area **A, do not start the engine. This could result in damage to the engine and catalytic converter. Contact a Technical Service.**

Topping up the engine oil

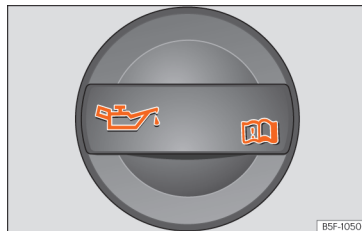


Fig. 187 In the engine compartment: Engine oil filler cap.

Before opening the bonnet, read and observe the warnings »» **⚠ in Working in the engine compartment on page 264**.

Topping up engine oil

- Unscrew cap from engine oil filler opening »» **Fig. 187**.
- Carefully add oil in small quantities (no more than 0.5 l).
- To avoid adding too much oil, whenever you add a certain amount, wait about 2 minutes and recheck the oil level »» **page 268**.
- If necessary, add some more oil.
- When the oil level reaches at least zone »» **Fig. 186 B**, unscrew the engine oil filler cap carefully »» ⓘ.


The position of the oil filler opening is shown in the corresponding engine compartment illustration »» page 266.

Engine oil specification »» page 266.


WARNING

Oil is highly inflammable! Ensure that no oil comes into contact with hot engine components when topping up.

CAUTION

If the oil level is above area »» Fig. 186 , do not start the engine. This could result in damage to the engine and catalytic converter. Contact a specialised workshop.

For the sake of the environment

The oil level must never be above zone »» Fig. 186 . Otherwise oil can be drawn in through the crankcase breather and leak into the atmosphere via the exhaust system.

Note

Before a long trip, we recommend finding an engine oil that conforms to the corresponding VW specifications and recommend keeping it in the vehicle. This way, the correct engine oil will always be available for a top-up if needed.

Engine oil change

We recommend that you have the engine oil changed by a Technical Service.

WARNING

Only change the engine oil yourself if you have the specialist knowledge required!

- Before opening the bonnet, read and observe the warnings »» page 264.
- Wait for the engine to cool down. Hot oil may cause burn injuries.
- Wear eye protection to avoid injuries, such as acid burns, caused by splashes of oil.
- When removing the oil drain plug with your fingers, keep your arm horizontal to help prevent oil from running down your arm.
- Wash your skin thoroughly if it comes into contact with engine oil.
- Engine oil is poisonous! Used oil must be stored in a safe place out of the reach of children.

CAUTION

No additives should be used with engine oil. This could result in engine damage. Any damage caused by the use of such additives would not be covered by the factory warranty.

For the sake of the environment

- We recommend that you change the engine oil and the filter at a technical service centre.
- Never pour oil down drains or into the ground.
- Use a suitable container when draining the used oil. It must be large enough to hold all the engine oil.

Cooling system

Coolant specifications

The engine cooling system is supplied from the factory with a specially treated mixture of water and at least 40 % of the additive **G12evo** (TL-VW 774 J), purple. This mixture gives the necessary frost protection down to -25°C (-13°F) and protects the light alloy parts of the engine cooling system against corrosion. It also prevents scaling and considerably raises the boiling point of the coolant.

To protect the cooling system, the percentage of additive must always be at least 40 %, even in warm climates where anti-freeze protection is not required.

If for weather reasons further protection is necessary, the proportion of additive may be »

increased, but only up to 60 %; otherwise anti-freeze protection will diminish and this will worsen cooling.

When the coolant is topped up, use a mixture of **distilled water** and at least 40 % of the additive **G12evo** for optimal protection against corrosion. Mixing **G12evo** with G13 (TL-VW 774 J), G12 plus-plus (TL-VW 774 G), G12 plus (TL-VW 774 F), G12 (red) or G11 (green blue) engine coolants decreases protection against corrosion and should be avoided.

⚠ WARNING

If there is not enough anti-freeze in the coolant system, the engine may fail leading to serious damage.

- Ensure that the percentage of additive is correct for the lowest expected ambient temperature in the zone in which the vehicle is to be used.
- When the outside temperature is very low, the coolant could freeze and the vehicle would be immobilised.

ⓘ CAUTION

The original additives should never be mixed with coolants which are not approved by SEAT.

- If the fluid in the expansion tank is not purple but is, for example, brown, this indicates that the G12evo additive has been

mixed with an inadequate coolant. The coolant must be changed as soon as possible if this is the case!

♻ For the sake of the environment

Coolants and additives can contaminate the environment. If any fluids are spilled, they should be collected and correctly disposed of, with respect to the environment.

Refilling coolant

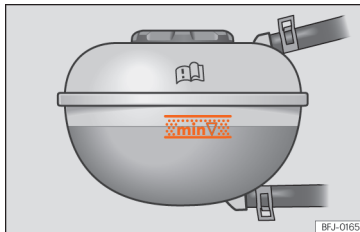


Fig. 188 In the engine compartment: marking on coolant expansion tank.



Fig. 189 Engine compartment: coolant expansion tank cap.

The coolant tank is located in the engine compartment »» page 266.

Top up coolant when the level is below the **MIN** (minimum) mark.

Checking coolant level

- Park the vehicle in a horizontal position.
- Switch the ignition off.
- Read off the coolant level on coolant expansion tank. When the engine is cold, the coolant level should be between the marks »» **Fig. 188**. When the engine is hot, it may be slightly above the upper mark.

Topping up coolant

- Wait for the engine to cool down.

- Cover the coolant expansion tank cap with a cloth and carefully unscrew it to the left »» ⚠.
- Top up the coolant only if there is still coolant in the expansion tank, otherwise you could **damage the engine**. If there is no coolant in the expansion tank, do not continue driving. You should obtain professional assistance »» ⚠.
- If there is still some coolant in the expansion tank, top up to the upper mark.
- Top up with coolant until the level becomes stable.
- Screw the cap back on correctly.

If there is a coolant leak, take the vehicle specialised workshop to have the cooling system examined.

⚠ WARNING

- The cooling system is under pressure. Do not unscrew the cap on the coolant expansion tank when the engine is hot: risk of burns!
- Store the antifreeze in its original container and keep it out of reach of children.
- If working inside the engine compartment, remember that, even when the ignition is switched off, the radiator fan may start up automatically, and therefore there is a risk of injury.

⚠ CAUTION

If you run out of coolant in the expansion tank, park the car in a safe place and do not continue driving. Obtain technical assistance.

Brake fluid

Check and refill the brake fluid



Fig. 190 Engine compartment: brake fluid reservoir cap.

The brake fluid reservoir is located in the engine compartment »» page 266.

Checking the brake fluid level

The brake fluid level must be between the **MIN** and **MAX** markings.

However, if the brake fluid level goes down noticeably in a short time, or drops below the **MIN** mark, there may be a leak in the brake system. Seek specialist assistance. A warning light on the instrument panel display monitors the brake fluid level »» page 84.

Changing brake fluid

We recommend that you have the brake fluid changed by a Technical Service.

⚠ WARNING

If the brake fluid level is low or unsuitable/old brake fluid is used, the brake system may fail or braking power may be reduced.

- Check the brake system and the brake fluid level regularly!
- When the brake fluid is used and brakes are subjected to extreme braking forces, bubbles of vapour form in the brake system. These bubbles can significantly reduce braking power, notably increasing braking distance, and could result in the total failure of the brake system.
- Be sure to always use the correct brake fluid. Only use brake fluid that expressly meets the VW 501 14 standard.
- You can buy VW 501 14 standard brake fluid in a SEAT dealership or a SEAT Official Service. If none is available, use only high-quality brake fluid that meets DIN ISO 4925 »»

CLASS 4 standards, or USA Standards FMVSS 116 DOT 4.

- The replacement brake fluid must be new.
- Brake fluid should be stored in the closed original container in a safe place out of reach of children. Risk of poisoning!

ⓘ CAUTION

Brake fluid should not come into contact with the vehicle paintwork, as it is abrasive.

♻️ For the sake of the environment

Brake fluid is an environmental pollutant. Collect any spilt service fluids and allow a professional to dispose of them.

Windscreen washer reservoir

Checking the level of the window washer tank and refilling it

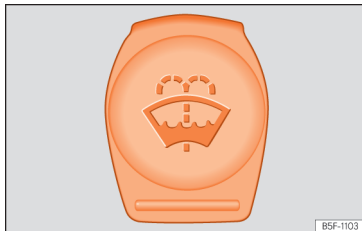


Fig. 191 In the engine compartment: window washer tank cap.

The window washer tank is in the engine compartment »» page 266.

Check the water level in the windscreen washer reservoir regularly and top up as required.

The window washer tank contains liquid detergent for the windscreen and rear window.

- Open the bonnet **▲** »» page 264.
- The window washer tank is marked with the **♻️** symbol on the cap.
- Check there is enough windscreen water in the reservoir.

Plain water is not enough to clean the windscreen and headlights. We recommend that you always add a product to the windscreen washer fluid.

Recommended windscreen wipers

- For the hottest seasons we recommend summer G 052 184 A1 for clear glass. Proportions of the mixture in the washer fluid tank: 1:100 (1 part concentrate per 100 parts water).
- All year round, G 052 164 A2 for clear glass. Approximate proportion of the winter mixture, up to -18°C (0°F): 1:2 (1 part concentrate per 2 parts water); otherwise, a 1:4 proportion of mixture in the washer fluid tank.

The capacity of the window washer tank can be found in »» page 302.

ⓘ CAUTION

If the water from the windscreen washer does not contain enough anti-freeze, it may freeze on the windscreen and rear window, reducing forward and rear visibility.

- In winter, ensure the windscreen washer contains enough anti-freeze.
- In cold conditions, you should not use the windscreen wiper system unless you have warmed the windscreen with the ventilation system. The antifreeze could freeze on the windscreen and reduce visibility.

ⓘ CAUTION

Never mix an unsuitable antifreeze or other similar additives with the windscreen washer water. A greasy layer may be formed on the windscreen which will impair visibility.

- Use clean water with a window cleaner recommended by SEAT.
- If necessary, add a suitable antifreeze to the water in the reservoir.

ⓘ CAUTION

Do not mix cleaning products recommended by SEAT with other products. This could lead to flocculation and may block the windscreen washer jets.

- When topping up service fluids, make absolutely certain that you fill the fluids into the correct reservoirs. Using the wrong fluids could cause serious malfunctions and engine damage!
- Lack of window washer fluid causes the view through the windscreen to be obscured.

12-volt battery

General information

The battery is located in the engine compartment and is almost **maintenance-free**. It is

checked as part of the Inspection Service. Nevertheless, check the terminals are clean and have the correct tightening torque, especially in summer and winter.

All work on batteries requires specialist knowledge. Please refer to a SEAT Official Service or a workshop specialising in batteries: risk of burns or exploding battery!

The battery must not be opened. Never try to change the fluid level of the battery. Otherwise explosive gas is released from the battery that could cause an explosion.

Battery warning indications



Wear eye protection.



Battery acid is extremely corrosive. Wear protective gloves and eye protection. Rinse any splashes of electrolyte with plenty of water.



Fires, sparks, open flames and smoking are prohibited.



The battery should only be charged in a well-ventilated zone. Risk of explosion!



Keep children away from acid and batteries!



Always follow the instruction manual.

Disconnecting the battery

The battery should only be disconnected in exceptional cases. When the battery is disconnected, some of the vehicle's functions

are lost. These functions will require resetting after the battery is reconnected.

When disconnecting the battery from the vehicle on-board network, disconnect first the negative cable and then the positive cable.

Deactivate the anti-theft alarm* before you disconnect the battery. Otherwise the alarm will be triggered.

Winter conditions

During the winter, the starting power may be reduced, and if necessary, the battery should be charged »»» ⚠



WARNING

Always be aware of the danger of injury and chemical burns as well as the risk of accident or fire when working on the battery and the electrical system:

- Wear eye protection. Protect your eyes, skin and clothing from acid and particles containing lead.
- Battery acid is extremely corrosive. Wear protective gloves and eye protection. Do not tilt the batteries. This could spill acid through the vents.
- Neutralise any electrolyte splashes on the skin, eyes or clothing with a soapy solution, and rinse off with plenty of water. If acid is swallowed by mistake, consult a doctor immediately.

»

- Fires, sparks, open flames and smoking are prohibited. When handling cables and electrical equipment, avoid causing sparks and electrostatic charge. Never short the battery terminals. High-energy sparks can cause injury.
- A highly explosive mixture of gases is released when the battery is under charge. The batteries should be charged in a well-ventilated room only.
- Keep children away from acid and batteries.
- Before working on the electrical system, you must switch off the engine, the ignition and all electrical devices. The negative cable on the battery must be disconnected. When a light bulb is changed, you need only switch off the light.
- Deactivate the anti-theft alarm by unlocking the vehicle before you disconnect the battery! The alarm will otherwise be triggered.
- When disconnecting the battery from the vehicle on-board network, disconnect first the negative cable and then the positive cable.
- Switch off all electrical devices before reconnecting the battery. Reconnect first the positive cable and then the negative cable. Never reverse the polarity of the connections. This could cause an electrical fire.

- Never charge a frozen battery, or one which has thawed. This could result in explosions and chemical burns. Always replace a battery which has frozen. A flat battery can also freeze at temperatures close to 0°C [+32°F].
- Ensure that the vent hose is always connected to the battery.
- Never use a defective battery. This could cause an explosion. Replace a damaged battery immediately.

⚠ CAUTION


- Do not expose the battery to direct sunlight over a long period of time, as the intense ultraviolet radiation can damage the battery housing.
- If the vehicle is left standing in cold conditions for a long period, protect the battery from "freezing". If it freezes it will be damaged.

Warning lamp

🔌 It lights up red

Alternator fault.

The control lamp lights up when the ignition is switched on. It should go out when the engine has started running.

If the control lamp  lights up while driving, the alternator is no longer charging the battery. You should immediately drive to the nearest specialised workshop.

You should avoid using electrical equipment that is not absolutely necessary because this will drain the battery.

Checking the battery electrolyte level

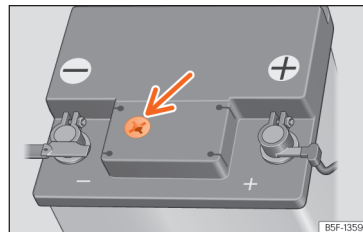



Fig. 192 Sight glass on the top of the 12 volt battery (schematic representation).

The electrolyte level should be checked regularly in high-mileage vehicles, in hot countries and in older batteries.

- Open the bonnet and then lift the cover that protects the front part of the battery **>>>**  in **Working in the engine compartment on page 264.**

- Check the colour display in the "magic eye" on the top of the battery.
- If there are air bubbles in the window, tap the window gently until they disperse.

The position of the battery is shown in the corresponding engine compartment diagram
»» page 266.

The "magic eye" indicator, located on the top of the battery changes colour, depending on the charge state and electrolyte level of the battery.

There are two different colours:

Yellow or colourless: The battery's electrolyte level is too low. Go to a specialised workshop to have the battery checked and replaced if necessary.

Black: The battery's electrolyte level is correct.

Charging or changing the battery

If you often drive short distances or if the vehicle is not driven for long periods, the battery should be checked by a specialised workshop between the scheduled services.

If the battery has discharged and you have problems starting the vehicle, the battery might be damaged. If this happens, we recommend you have the vehicle battery

checked by a Technical Service where it will be re-charged or replaced.

Charging the battery

The vehicle battery should be charged by a specialised workshop only, as batteries using special technology have been installed and they must be charged in a controlled environment.


Replacing a vehicle battery

The battery has been developed to suit the conditions of its location and has special safety features. If the battery must be replaced, consult a technical service for information on electromagnetic compatibility, the size and maintenance, performance and safety requirements of the new battery in your vehicle before you purchase one. SEAT recommends you have the battery replaced by a technical service.

Start-Stop systems (»» page 196) are equipped with a special battery. Therefore, it must only be replaced with a battery of the same specifications.

WARNING

- Always use only maintenance free batteries that do not run flat alone and whose properties, specifications and size correspond to the standard battery. The specifications are indicated on the battery case.

- Before starting any work on the batteries, you must read and observe the warnings
»»  in General information on page 273.

For the sake of the environment

- ⚠ Batteries contain toxic substances such as sulphuric acid and lead. They must be disposed of appropriately and must not be disposed of with ordinary household waste.

Wheels

Wheels and tyres

General notes

- When driving with **new tyres**, be especially careful during the first 500 km (300 miles).
- If you have to drive over a kerb or similar obstacle, drive very slowly and as near as possible at a right angle to the obstacle.
- Check from time to time if the tyres are damaged (punctures, cuts, cracks or dents). Remove any foreign objects embedded in the treads.
- Damaged wheels and tyres must be replaced immediately.
- Keep grease, oil and fuel off the tyres.
- Replace any missing valve caps as soon as possible.
- Mark the wheels before taking them off so that they rotate in the same direction when put back.
- When removed, the wheels or tyres should be stored in a cool, dry and preferably dark place.

Low profile tyres

Low profile tyres have a wider tread, a larger wheel diameter and a lower sidewall height. Therefore, its driving behaviour is more agile.

Low profile tyres may deteriorate more quickly than standard tyres, for instance due to strong knocks, potholes, manhole covers and kerbs. Correct tyre pressure is very important »» page 278.

To avoid damage to tyres and wheels, drive with special care when driving on roads in poor condition.

Visually check your wheels every 3000 km.

If the tyres or rims have received a heavy impact or have been damaged, have a specialised workshop check whether or not it is necessary to change the tyre.

Low profile tyres may deteriorate more quickly than standard tyres.

Concealed damage

Damage to tyres and rims is often not readily visible. If you notice unusual **vibration** or the car **pulling to one side**, this may indicate that one of the tyres is damaged. Reduce speed immediately if there is any reason to suspect that damage may have occurred. Inspect the tyres for damage. If no external damage is visible, drive slowly and carefully to the nearest specialised workshop and have the car inspected.

Foreign objects inserted in the tyre

- Do not remove foreign bodies if they have penetrated through the tyre wall!
- If the vehicle comes with a tyre mobility system, where necessary seal the damaged tyre as shown in section »» page 40. Use a specialised workshop for repair or replacement. SEAT recommends visiting a SEAT dealership for this.

The sealant at the lower part of the tyre tread wraps around the foreign body and provisionally seals the tyre.

Tyres with directional tread pattern

An arrow on the tyre sidewall indicates the direction of rotation on single drive tyres. Always note the direction of rotation indicated when mounting the wheel. This makes sure that optimal use is made of tyre properties in terms of aquaplaning, grip, excessive noise and wear.

Subsequent fitting of accessories

If you wish to change or fit wheels, rims or wheel trims, we recommend that you consult with a SEAT Official Service centre for advice regarding current techniques.

Speed symbols

The speed rating indicates the maximum speed permitted for the tyres.

P	max. 150 km/h [93 mph]
Q	max. 160 km/h [99 mph]
R	max. 170 km/h [106 mph]
S	max. 180 km/h [112 mph]
T	max. 190 km/h [118 mph]
U	max. 200 km/h [124 mph]
H	max. 210 km/h [130 mph]
V	max. 240 km/h [149 mph]



Some manufacturers use the letters "ZR" for tyres with a maximum authorised speed above 240 km/h [149 mph].

WARNING

- New tyres do not have maximum grip during the first 500 km. Drive particularly carefully to avoid possible accidents.
- Never drive with damaged tyres. This may cause an accident.
- If you notice unusual vibrations or if the vehicle pulls to one side when driving, stop the vehicle immediately and check the tyres.
- Never use old tyres or those with an unknown history of use.

New wheels and tyres

It is best to have all wheels and tyres serviced by a specialised workshop. There they have the required knowledge, the special tools and the corresponding spare parts.

- Even winter tyres lose their grip on ice. If you have installed new tyres, drive the first 500 km carefully and at a moderate speed.
- All four wheels must be fitted with tyres of the same type, size (rolling circumference) and, if possible, tread pattern.
- When changing tyres, do not change just one; change at least two on the same axle.
- If you want to equip your vehicle with a combination tyres and rims that are different to those fitted in the factory, inform your specialised workshop before purchasing them  

The sizes of the rims and tyres approved for your vehicle are listed in the vehicle documentation (e.g. EC Certificate of Conformity or COC document¹⁾). The vehicle documentation varies depending on the country of residence.

If the type of spare wheel is different from the normal wheels — e.g. in the case of winter tyres or particularly wide tyres — the spare wheel should only be used temporarily in the

event of a puncture, and the vehicle should be driven with care. Refit the normal road wheel as soon as possible.


Manufacturing date

The manufacturing date is also indicated on the tyre sidewall (or on the inside face of the wheel):

DOT ... 2218 ...

it means, for example, that the tyre was manufactured in the 22nd week of 2018.

WARNING

- Use only combinations of tyres and rims, as well as suitable wheel nuts, approved by SEAT. Otherwise the vehicle may be damaged, causing an accident.
- For technical reasons it is not possible to use wheels of other vehicles; in some cases not even wheels from the same vehicle model should be used.
- Always ensure that the tyres you have chosen have adequate clearance. When selecting replacement tyres, do not rely entirely on the nominal tyre size marked on the tyre, since the nominal tyre size can differ significantly depending on the manufacturer. Lack of clearance can damage the tyres or the vehicle and, as a result, endanger road safety. Risk of accident! 

¹⁾ COC = certificate of conformity.

- Only use tyres that are over 6 years old in an emergency, and drive with due care.
- The fitting of tyres with run-flat properties is not permitted on your vehicle! Prohibited use can cause accidents or can damage your vehicle.
- If decorative hubcaps are subsequently fitted, make sure that they allow enough air in to cool the braking system. Risk of accident!

For the sake of the environment

Old tyres must be disposed of according to the laws in the country concerned.

Note

- A SEAT Service Centre should be consulted to find out whether wheels or tyres of different sizes to those originally fitted by SEAT can be fitted, and to find out about the combinations allowed between the front axle (axle 1) and the rear axle (axle 2).
- Never mount used tyres if you are not sure of their "previous history".

Tyre life

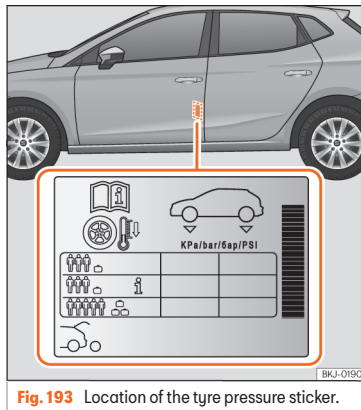


Fig. 193 Location of the tyre pressure sticker.

Correct inflation pressures and sensible driving habits will increase the useful life of your tyres.

- Check tyre pressure at least once a month, and also prior to any long trip.
- The tyre pressure should only be checked when the tyres are *cold*. Do not reduce the pressure of warm tyres.
- Adjust tyre pressure to the load being carried by the vehicle »» **Fig. 193**.
- In vehicles with a tyre pressure indicator, save the modified tyre pressure »» **page 282**.

- Avoid fast cornering and hard acceleration.
- Inspect the tyres for irregular wear from time to time.

Tyre pressure

The tyre inflation pressures are listed on a sticker on the rear of the front left door frame »» **Fig. 193**.

Insufficient or excessive pressure greatly reduces the useful life of the tyres and adversely affects vehicle performance and ride. Correct inflation pressures are very important, especially at **high speeds**.

Depending on the vehicle, tyre pressure can be adjusted to medium load to improve driving comfort (tyre pressure **i**) »» **Fig. 193**. When driving with comfort tyre pressure fuel consumption may increase slightly.

The tyre pressure must be adjusted according to the load the vehicle is carrying. If the vehicle is going to carry the maximum load, the tyre pressure should be increased to the maximum value indicated on the sticker »» **Fig. 193**.

Do not forget the spare wheel when checking the tyre pressures: Keep this spare wheel inflated to the highest pressure required for the road wheels.

In the case of a minimised temporary spare wheel (125/70 R16 or 125/70 R18), inflate to a

pressure of 4.2 bar as indicated on the tyre pressure label » **Fig. 193.**

Driving style

Fast cornering, heavy acceleration and hard braking (squealing tyres) all increase tyre wear.

Wheel balance

The wheels on new vehicles are balanced. However, certain circumstances may lead to imbalance (run-out), which is detected as vibrations in the steering wheel.

Unbalanced wheels should be rebalanced, as they otherwise cause excessive wear on steering, suspension and tyres. A wheel must also be rebalanced when a new tyre is fitted or if a tyre is repaired.

Incorrect wheel alignment

Incorrect running gear alignment causes excessive tyre wear, impairing the safety of the vehicle. If you notice excessive tyre wear, you should check wheel alignment at a SEAT Official Service.

⚠ WARNING

Unsuitable handling of the wheels and tyres may lead to sudden tyre pressure losses, to tread separation or even to a blow-out.

- The driver is responsible for ensuring that all of the vehicle tyres are correctly inflated to the right pressure. The recommended tyre pressure is indicated on the label » **Fig. 193.**

- Check tyre pressures regularly and ensure they are maintained at the pressures indicated. Tyre pressure that is too low could cause overheating, resulting in tread detachment or even burst tyres.

- When the tyres are cold, tyre pressure should be that indicated on the label » **Fig. 193.**

- Regularly check the cold inflation pressure of the tyres. If necessary, change the tyre pressure of the vehicle tyres while they are cold.

- Regularly check your tyres for damage and wear.

- Never exceed the maximum permitted speed or loads specified for the type of tyre fitted on your vehicle.

♻ For the sake of the environment

Under-inflated tyres will increase fuel consumption.

Tread wear indicators

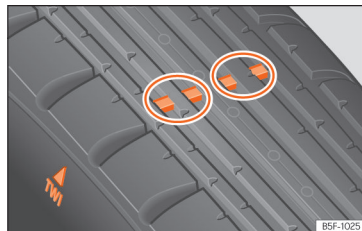


Fig. 194 Tyre profile: tread wear indicators.

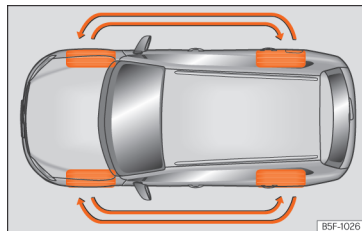



Fig. 195 Interchanging tyres.

Wear indicators around 1.6 mm high can be found on the base of the original tyre treads, ordered at regular intervals and running across the tread » **Fig. 194.** The letters "TWI" or triangles on the sidewall of the tyre mark the position of the wear indicators. »

The minimum permitted profile depth¹⁾ have been reached when the tyres have worn down to the wear indicators. Replace the tyres with new ones »» .

Changing wheels around

To ensure that the wear is equal on all tyres the wheels should be changed round from time to time according to the system »» **Fig. 195**. The useful life of all the tyres will then be about the same time.

WARNING

The tyres must be replaced at the latest when the tread is worn down to the tread wear indicators. Failure to follow this instruction could result in an accident.

- Particularly in difficult driving conditions such as wet or icy roads. It is important that the tyre tread be as deep as possible and be approximately the same on the tyres of both the front and the rear axles.
- The scant driving safety due to insufficient tread depth is particularly evident in vehicle handling, when there is a risk of “aquaplaning” in deep puddles of water and when driving through corners, and braking is also adversely affected.

- The speed has to be adapted accordingly, otherwise there is a risk of losing control over the vehicle.

Wheel nuts

The **wheel nuts** are matched to the rims. When installing different wheels (for instance alloy wheels or wheels with winter tyres) it is important to use the correct wheel nuts with the right length and correctly shaped bolt heads. This ensures that wheels are fitted securely and that the brake system functions correctly.

The wheel nuts must be clean and turn easily.

A special adapter is required to turn the anti-theft wheel nuts* »» page 44.

WARNING

Wheel nuts should never be greased or oiled.

- Use only wheel nuts which belong to the wheel.
- If the prescribed torque of the wheel nuts is too low, they could loosen whilst the vehicle is in motion. Risk of accident! If the

tightening torque is too high, the wheel nuts and threads can be damaged.

CAUTION

See »» page 47 to find out the recommended tightening torque for wheel nuts for steel and alloy rims.

Winter tyres

- Winter tyres must be fitted **on all four** wheels.
- Only use winter tyres that are approved for your vehicle.
- Please note that the maximum permissible speed for winter tyres may be lower than for summer tyres.
- Also note that winter tyres are no longer effective when the **tread** is worn down.
- After fitting the wheels you must always check the tyre pressures. When doing so, take into account the correct tyre pressures listed on the rear of the front left door frame »» page 278.

In winter road conditions winter tyres will considerably improve vehicle handling. The

¹⁾ Follow the regulations of the country you are driving in.

design of summer tyres (width, rubber compound, tread pattern) gives less grip on ice and snow. This applies particularly to vehicles equipped with **wide section tyres** or with **high speed tyres** (code letters H, V or Y on the sidewall).

Only use winter tyres of the correct type approved for your vehicle. The sizes of these tyres are specified in the vehicle's documents (e.g. EC Certificate of Conformity or COC¹⁾). The vehicle documentation varies depending on the country of residence.

Winter tyres lose a great deal of their properties when the **tread** is worn down to a depth of 4 mm.

The performance of winter tyres is also severely impaired by **ageing**, even if the tread is still much deeper than 4 mm.

A code letter indicating the speed limit is stamped on all winter tyres »» page 276.

Vehicles capable of exceeding these speeds must have an appropriate **sticker** attached so that it is visible to the driver. Suitable stickers are available from the SEAT Official Service and specialised workshop. Please note the regulations to this effect in your country.

"All-weather" tyres can also be used instead of winter tyres.

Using winter tyres with V-rating

Please note that the generally applicable 240 km/h (149 mph) speed for winter tyres with the letter V is subject to **technical restrictions; the maximum permissible speed for your vehicle may be significantly lower**. The maximum speed limit for these tyres depends directly on the maximum axle weights for your car and on the listed weight rating of the tyres being used.

It is best to contact a SEAT Official Service to check the maximum speed which is permissible for the V-rated tyres fitted on your car on the basis of this information.

WARNING

Exceeding the maximum speed permitted for the winter tyres fitted on your car can cause tyre failure, resulting in a loss of control of the vehicle – risk of accident.

For the sake of the environment

When winter is over, change back to summer tyres at an appropriate moment. In temperatures above +7°C [+45°F], performance will be improved if summer tyres are used. Fuel consumption, wear and noises while driving will all be reduced.

Snow chains

Snow chains should **only be used on the front wheels**.

- Check that they are correctly seated after driving for a few yards; correct the position if necessary, in accordance with the manufacturer's fitting instructions.
- Keep your speed below 50 km/h (30 mph).
- If there is a danger of being trapped despite having mounted the chains, it is best to disable the driving wheels (ASR) in the ESC »» page 233, **Connecting and disconnecting the ESC and ASR***.

Snow chains will improve *braking ability* as well as *traction* in winter conditions.

For technical reasons snow chains may only be used with the following wheel rim/tyre combination. »

¹⁾ COC = certificate of conformity.

Tyres	Wheel rim	Chains
185/70 R14	5Jx14 ET38	Max. link 13.5 mm
185/65 R15	5.5Jx15 ET40	
185/60 R16	6Jx16 ET45	
195/55 R16	6Jx16 ET45	Max. link 9 mm
185/60 R16	6.5Jx16 ET47	
195/55 R16	6.5Jx16 ET47	
215/45 R17	7Jx17 ET51	
215/40 R18	7Jx18 ET51	
Other dimensions do not allow chains		

Remove any central wheel trims and the rim ring before fitting snow chains.

⚠ WARNING

The use of unsuitable or incorrectly fitted chains could lead to serious accidents and damage.

- Always use the appropriate snow chains.
- Observe the fitting instructions provided by the snow chain manufacturer.
- Never exceed the maximum permitted speeds when driving with snow chains.

ⓘ CAUTION

- Remove the snow chains to drive on roads without snow. Otherwise they will im-

pair vehicle handling, damage the tyres and wear out very quickly.

- Wheel rims may be damaged or scratched if the chains come into direct contact with them. SEAT recommends the use of covered snow chains.

Tyre pressure loss indicator*

Control lamp

⚠ It lights up

The tyre pressure of a wheel is much lower than the value set by the driver »»» ⚠ in Tyre pressure monitor indicator on page 283.

Or: Fault in the tyre pressure gauge.

Several control and warning lamps light up for a few seconds when the ignition is switched on while the function is verified. They will switch off after a few seconds.

⚠ WARNING

Observe the safety warnings »»» ⚠ in Control and warning lamps on page 85.

Tyre pressure monitor indicator



Fig. 196 Centre console: tyre pressure loss indicator button.

The tyre pressure monitor indicator compares wheel revolutions and, with this information, the tread of each wheel using the ABS sensors.

The tyre pressure monitor indicator warns of any change in the tread diameter of a wheel ⚠.

Wheel tread change

The wheel diameter changes when:


- Tyre pressure is changed manually.
- Tyre pressure is insufficient.
- The tyre structure is damaged.
- The vehicle is unbalanced because of a load.

- The wheels on an axle are subject to a heavier load (e.g. with a heavy load).
- The vehicle is fitted with snow chains.
- The temporary spare wheel is fitted.
- The wheel on one axle is changed.

There may be a delay in the reaction of the tyre pressure monitoring indicator (⚠) or it may not indicate anything under certain circumstances (e.g. sporty driving, snow-covered or unpaved roads, or when driving with snow chains).

Calibrate the tyre pressure monitoring indicator

After changing the tyre pressure or replacing one or more wheels, the tyre pressure monitoring indicator must be recalibrated. Do the same, for example, when the front and rear wheels are swapped.

- Switch the ignition on.
- Use the button **CAR /**  **> SETTINGS > Tyres** »» page 90 to save the new tyre pressure in the Easy Connect system.
- *Vehicles without the Easy Connect system:* press and hold button (⚠) **SET** »» Fig. 196 until a sound is heard.

When driving, the system self-calibrates the tyre pressure provided by the driver and the wheels fitted. After a long journey with varied

speeds the programmed values are collected and monitored.

With the wheels under very heavy loads, the tyre pressure must be increased to the total recommended tyre pressure before calibration »» Fig. 193.

If the tyre monitor system button is pressed down, the new tyre pressures are confirmed.

WARNING

When the tyres are inflated at different pressures or at a pressure that is too low then a tyre may be damaged resulting in a loss of control of the vehicle and a serious or fatal accident.

- If the lamp (⚠) lights up, reduce speed immediately and avoid any sudden turning or braking manoeuvre. Stop when possible, and check the tyre pressure and status.
- The tyre monitoring system can only operate correctly if all of the tyres are inflated to the correct pressure when cold.
- If a tyre has not been punctured and it does not have to be changed immediately, drive to the nearest specialised workshop at a moderate speed and have the tyre checked and inflated to the correct pressure.

Note

- Driving for the first time with new tyres at a high speed can cause them to slightly ex-

pand, which could then produce an air pressure warning.

- Do not only rely on the tyre monitoring system. Regularly check your tyres to ensure that the tyre pressure is correct and that the tyres are not damaged due to puncture, cuts, tears and impacts/dents. Remove objects from the tyres only when they have not pierced the tyres.
- The tyre pressure monitoring indicator does not function when there is a fault in the ESC or ABS »» page 231.
- If the battery is disconnected, the yellow warning lamp (⚠) lights up after turning the ignition on. This should turn off after a brief journey.

Spare wheel

Location and use of the temporary spare wheel

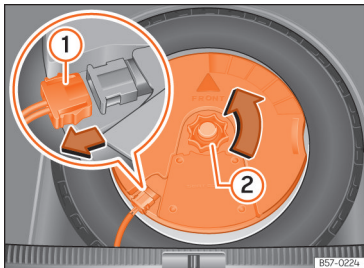


Fig. 197 In the luggage compartment: remove the subwoofer.

The temporary spare wheel is stored under the floor panel in the luggage compartment and is attached by a thumbnut.

The temporary spare wheel has been designed to be used for short periods of time. Have the tyres checked and replaced as soon as possible at a SEAT Official Service or at a specialised workshop.

The spare wheel must not be switched for a spare wheel from another vehicle.

Removing the temporary spare wheel

- Lift and hold up the floor panel to remove the temporary spare wheel »» page 133.
- Turn the thumb wheel anti-clockwise.
- Take out the temporary spare wheel.

Getting the spare wheel out of vehicles with BEATS Audio 6 speakers (with subwoofer)*

To remove the spare wheel, you must first remove the subwoofer.

- *Vehicles without a variable floor in the luggage compartment:* pull the floor of the luggage compartment (carpet) upwards to get it out.
- *Vehicles with a variable luggage compartment floor:* lift and secure the floor luggage compartment as explained in »» page 133.
- Disconnect the *subwoofer* »» Fig. 197 ① speaker cable.
- Turn the securing wheel in an anti-clockwise direction »» Fig. 197 ②.
- Remove the *subwoofer* speaker and the spare wheel.
- When re-mounting the spare tyre, place the *subwoofer* on the base of the wheel rim with care. When doing so, the tip of the "FRONT" arrow on the *subwoofer* should point forward.
- Reconnect the speaker cable and firmly rotate the securing wheel clockwise so that the

subwoofer system and wheel are firmly in place.

Chains

For technical reasons, snow chains must not be used on the temporary spare wheel.

If you have a puncture on one of the front wheels when using snow chains, fit the temporary spare wheel in place of one of the rear wheels. Fit the snow chains on the rear wheel that you have removed and replace the punctured front wheel with this wheel.

⚠ WARNING

- After fitting the temporary spare wheel, check the tyre pressures as soon as possible. Failure to do so may cause an accident. The tyre pressure is listed on the back of the left front door frame »» Fig. 193.
- Do not drive at over 80 km/h (50 mph) when the temporary spare wheel is fitted on the vehicle: risk of accident!
- Never travel more than 200 km using a temporary spare wheel.
- Avoid heavy acceleration, hard braking and fast cornering: risk of accident!
- Never use more than one temporary spare wheel at the same time, risk of accident.
- No other type of tyre (normal summer or winter tyre) may be fitted on the compact temporary spare wheel rim.

- If you are driving using the spare wheel, the ACC system could automatically switch off during the journey. Switch off the system when starting off.

Maintenance

SEAT Maintenance Programme

Service intervals

Service work and the Digital Maintenance Plan

Log of services performed (“Digital Maintenance Plan”)

The SEAT dealership or a specialised workshop records Service receipts in a central system. Thanks to this comprehensive documentation of the service history, it is possible to reproduce the services performed any time. SEAT recommends requesting a Service receipt after every service carried out containing all the services carried out on the system.

Whenever there is a new service the receipt is replaced with a current one.

The Digital Maintenance Plan is not available in some markets. In this case, your SEAT dealer will inform you about the current documentation of the work.

Service works

In the Digital Maintenance Plan, your SEAT authorised service or specialised workshop documents the following information:

- When each one of the services was carried out.
- Whether a specific repair has been suggested, e.g. changing the brake pads in the near future.
- If you have expressed a special request for the maintenance. Your Service Advisor will write the work order.
- The components or fluids that were changed.
- The date of the next service.

The Long Life Mobility Warranty is valid until the next inspection. This information is documented in all checks performed.

The type and the volume of the service may vary from one vehicle to another. A specialised workshop will be able to provide specific information on the jobs for your vehicle.

WARNING

If the services are insufficient or not performed and if the service intervals are not observed, the vehicle may be immobilised in traffic cause an accident and severe injuries.

- **Make sure that any repairs are carried out by a SEAT authorised service or specialised workshop.**

CAUTION

SEAT cannot be held liable for any damage to the vehicle due to insufficient work or of lack of availability of spare parts.

Note

Regular services on the vehicle not only maintain its value, but also its correct operation and road safety. For this reason, conduct the services in accordance with SEAT guidelines.

Set Service or Flexible Service Intervals

Services are classified as **oil change service** and **inspection**. The service interval display on the instrument panel display serves as a reminder of the next service.

Depending on the features, the engine and the conditions of use of the car, either the **Fixed service** or the **Flexible service** will be applied for an oil change service..

How to know which type of service needs to his vehicle

- Check the tables below:

Oil change service ^{a)}		
PR No.	Type of service	Service interval
Q11	Fixed	Every 5000 km or after 1 year^{b)}
Q12		Every 7500 km or after 1 year^{b)}
Q13		Every 10000 km or after 1 year^{b)}
Q14		Every 15000 km or after 1 year^{b)}
Q16	Flexible	According to the service interval display

^{a)} The data are based on normal conditions of use.

^{b)} Whatever happens first.

Inspection Service^{a)}

According to the service interval display

^{a)} The data are based on normal conditions of use.

Particular characteristics of the Flexible Service

Regarding the **Flexible Service**, the oil change service only has to be performed when the vehicle needs it. To calculate when

you have to carry out this service, take into account the individual conditions of use and personal driving style. A major component of the flexible service is the use of LongLife oil instead of conventional engine oil.

Bear in mind the information about the specifications of the engine oil according to the VW standard »» page 266.

If you do not want to the flexible service you can select the fixed service. However, a fixed service may affect service costs. The Service Advisor will gladly advise you.

Service interval display

At SEAT, the dates of the services are indicated by the service interval display on the instrument panel »» page 81 or in the **Vehicle settings** menu of the infotainment system »» page 86.

The service interval display gives information for service dates that involve an engine oil change or an inspection. When the time for the corresponding service comes, additional work required, such as the change of brake fluid and the spark plugs, can be carried out.

Information about the terms of use

The service intervals and groups are usually based on **normal conditions of use**.

If, on the other hand, the vehicle is under **adverse conditions of use**, some of the work must be carried out before the next service period or even between service intervals.

Conditions of use adverse include:

- The use of fuel with a high sulphur content.
- Frequent short trips.
- Letting the engine idle for a long period of time, as in the case of taxis.
- Using the vehicle in areas with thick dust.
- Frequent driving with a trailer (depending on equipment).
- Using the vehicle mostly in situations with a lot of traffic and stops (e.g. in a city).
- Using the vehicle mostly in winter.

This applies especially for the following parts (depending on equipment):

- Dust and pollen filter
- Air Care allergen filter
- Air filter
- Toothed chain
- Particulate filter
- Engine oil

The Service Advisor of your specialised workshop will gladly inform you about the need of performing service work between »

normal service intervals, always considering the conditions of use of your vehicle.

WARNING

If the services are insufficient or not performed and if the service intervals are not observed, the vehicle may be immobilised in traffic and cause accidents and severe injuries.

- Have the services conducted at authorised SEAT services or specialised workshops.

CAUTION

SEAT cannot be held liable for any damage to the vehicle due to insufficient work or of lack of availability of spare parts.

Service sets

Sets of services include all the **maintenance works** needed to ensure the safety and the smooth running of the vehicle (**depending on the conditions of use and the features of the vehicle**, such as the engine, gearbox, or operating fluids). Maintenance services are divided into *inspection* and *review* services. Consult the details of the jobs required for your vehicle at:

- Your SEAT authorised service
- Your specialised workshop

Due to technical reasons (continuous development of components) the sets of services may vary. Your SEAT authorised service or specialised workshop is always receiving updates in time.

Additional service offers

Approved spare parts

Original SEAT Spare Parts have been conceived for their vehicles and approved by SEAT, with a special emphasis on safety. These parts correspond exactly to the manufacturer's requirements in terms of design, accuracy of the measurements and materials. The original SEAT Spare Parts have been conceived exclusively for your vehicle. For this reason, we always recommend the use of Original SEAT Spare Parts. SEAT cannot be held liable for the safety and suitability of parts from other manufacturers.

Approved spare parts

Approved spare parts, following the manufacturer's requirements, are an additional service to you, offering the possibility of replacing complete sets, such as: light engine, gearboxes, heads, control units, electrical components, etc.

These parts are, **approved parts**, and are the same as the factory parts, which are also approved spare parts.

Original accessories

We recommend you only use SEAT Original Accessories and SEAT approved accessories for your vehicle. The reliability, safety and suitability of these accessories have been inspected specifically for this type of vehicle. SEAT cannot be held liable for the safety and suitability of parts from other manufacturers.

SEAT Service Mobility

Since the moment you purchase your SEAT vehicle you will be able to enjoy the benefits and coverage of the SEAT Mobility Service.

For the first two years after the purchase, your new SEAT vehicle is automatically covered by the SEAT Mobility Service without additional costs.

If you wish to enjoy this service after this period, you can extend SEAT Mobility as long as you carry out the recommended Inspection and Maintenance Services at a SEAT Authorised Service.

If your SEAT vehicle is immobilised due to a fault or an accident, our assistance services will help you keep moving.

Take into account that the SEAT Mobility Service differs depending on the country in which the vehicle was purchased. For further information ask your SEAT dealership or the SEAT website in your country.

Warranty

Fault-free operation warranty

SEAT Authorised Services ensure the perfect condition of new vehicles. Check the purchase agreement or complementary additional documentation provided by your Technical Service to see the conditions and the terms of the warranty. Consult further information in this regard in your SEAT Official Service.

Vehicle maintenance

Maintenance and cleaning

Basic observations

Regular and careful care helps to maintain the value of your vehicle. In addition, it may become a prerequisite to demand the warranty in the event of corrosion damage and deficiencies in the paint coat of the bodywork.

Specialised workshops have the necessary care products. Please follow the instructions for application on the packaging.

WARNING

- **Cleaning products and other materials used for car care can be damaging to your health if misused.**
- **Always keep care products in a safe place, out of the reach of children. Danger of poisoning!**

For the sake of the environment

- **When purchasing car care products, chose products that are compatible with the environment.**
- **The waste from car-care products should not be disposed of with ordinary household waste.**

Washing the vehicle

The longer you take to clean the tanks, e.g. remains of insects, bird excrements, tree resin or anti frost salt adhered to your vehicle, the more damage it can cause to the surface. High temperatures, for instance strong sunlight, further intensify the damage.

Before washing the car, soften the dirt using plenty of water.

To remove encrusted dirt such as insects, bird droppings or tree resin, use a lot of water and a microfibre cloth.

Have the underside of the vehicle washed after the end of the anti frost salts in winter.

High pressure cleaning equipment

When washing the vehicle with a high-pressure cleaner, always follow the operating instructions for the equipment. This applies particularly to the operating pressure and the distance between the spraying water. Do not aim the jet directly to the side window gaskets, doors, covers or the panoramic sunroof*; the same applies to tyres, rubber hoses, soundproofing material, sensors* or camera lenses*. Keep a distance of at least 40 cm.

Do not remove snow and ice with a high-pressure cleaner.



Do not use a nozzle that sprays the water out in a direct stream or one that has a rotating jet for forcing off dirt.

The water temperature must not exceed 60°C.

Automatic car washes

Spray the vehicle before starting the car wash.

Make sure that the windows and the panoramic sunroof* are closed and the windscreen wipers are deactivated. Bear in mind the instructions of the car wash tunnel operator, especially if your vehicle has detachable parts.

Use of car washes without brushes if possible.

Washing by hand

Clean your vehicle from top to bottom with a soft sponge or with a brush. Only use cleaning products that do not contain solvents.

Washing vehicles with a matte paint by hand

To prevent damage to the vehicle when washing it, first remove the thicker dust and dirt. To remove traces of insects, grease and fingerprints, it is best to use a special cleaner for matte paint.

Apply the product with a microfibre cloth. To avoid damaging the surface of the paint, do not apply too much pressure.

Rinse with plenty of water. Then clean it with a neutral cleaning product and a soft microfibre cloth.

Rinse the vehicle again with plenty of water and then leave it to dry. Remove traces of water with a leather cloth.

WARNING

- Only wash the vehicle with the ignition switched off or according to the specifications of the car wash tunnel operator. Risk of accident!
- When cleaning the underbody or the inside of the wheel arches, protect yourself from sharp or pointy metal parts. Risk of cut!
- After cleaning the brakes could act more slowly due to moisture or, in winter, the ice on the brake discs and pads. Risk of accident! In this case the brakes should be dried by pressing the brake pedal several times.

CAUTION

- Before washing the vehicle in an automatic car wash, please make sure to retract the exterior mirrors to prevent them from being damaged. The electric folding*

exterior mirrors should only be folded electrically!

- Do not wash the vehicle in direct sunlight. Risk of damaging the paint job!
- Do not use sponges, abrasive household sponges or similar to clean insect remains. Risk of damaging the surface!
- Vehicle parts with matte paint:
 - Do not use polish or hard wax. Risk of damaging the surface!
 - Never select washing programs that include the use of wax. This could damage the appearance of matte paint.
 - Do not put stickers or magnets on parts with matte paint, as removing them may damage the paint.

For the sake of the environment

The car should only be washed in special wash bays. These places are prepared to prevent oily water from getting into the public drains.

Cleaning and maintenance instructions

The cleaning and maintenance of individual components of the vehicle can be checked in the following tables. The contents should be understood merely as a recommendation. Go to your specialised workshop if you have

special questions or parts that are not listed. Take the general considerations into account »» **△** in **Take special care with...** on page 294.

Cleaning the exterior

Windscreen wipers

Problem	Solution
Dirt	Soft cloth with wipers

Headlights / Tail lights

Problem	Solution
Dirt	Soft sponge with neutral soap solution ^{a1}

^{a1} Neutral soap solution: two tablespoons maximum in 1 litre of water

Sensors / Camera lenses

Problem	Solution
Dirt	<i>Sensors:</i> soft cloth with a solvent-free cleaning product <i>Camera lenses:</i> soft cloth with an alcohol-free cleaning product
Snow/ice	Hand brush/Anti frost spray with no solvents

Wheels

Problem	Solution
Antifreeze salt	Water
Brake abrasion dust	Acid-free special cleaning product

End exhausts

Problem	Solution
Antifreeze salt	Water, if a steel cleaning product is required

Covers / Trims

Problem	Solution
Dirt	Neutral soap solution ^{a1} , if a steel cleaning product is required

^{a1} Neutral soap solution: two tablespoons maximum in 1 litre of water

Paint

Problem	Solution
Paint flaws	Check the paint's colour code in an authorised service and restore with a touch-up pencil
Spilled fuel	Immediately rinse with water
Environmental rust tank	Apply rust remover and then apply hard wax. Go to your specialised workshop if you have any queries

Problem	Solution
Corrosion	Have your specialised workshop take care of this
The water does not create droplets on the clean paint	Maintain with hard wax (at least 2 times a year)
No shine despite sober maintenance/paint	Treat with suitable wax and apply paint preservative afterwards if the wax used does not contain preservative ingredients
Tanks, e.g. insect remains, bird droppings, tree sap, road salt	Immediately soften with water and remove with a microfibre cloth
Fat-based dirt, e.g. cosmetic products or sunscreen	Delete immediately with a neutral soap solution ^{a1} and a soft cloth

^{a1} Neutral soap solution: two tablespoons maximum in 1 litre of water

Carbon fibre parts

Problem	Solution
Dirt	Clean the same way as painted parts »» page 289 »

Decoration slides

Problem	Solution
Dirt	Soft sponge with neutral soap solution ^{a1}

^{a1} Neutral soap solution: two tablespoons maximum in 1 litre of water

Interior cleaning

Windows

Problem	Solution
Dirt	Apply windscreen cleaner and then dry with a cloth

Covers / Trims

Problem	Solution
Dirt	Neutral soap solution ^{a1}

^{a1} Neutral soap solution: two tablespoons maximum in 1 litre of water

Plastic parts

Problem	Solution
Dirt	Damp cloth
Encrusted dirt	Neutral soap solution ^{a1} , if possible solvent-free plastic cleaner

^{a1} Neutral soap solution: two tablespoons maximum in 1 litre of water

Displays/instrument panel

Problem	Solution
Dirt	Soft cloth with a liquid crystal display cleaner

Control panels

Problem	Solution
Dirt	Soft brush, then soft cloth with neutral soap solution ^{a1}

^{a1} Neutral soap solution: two tablespoons maximum in 1 litre of water

Seat belts

Problem	Solution
Dirt	Neutral soap solution ^{a1} , allowed to dry before retracting

^{a1} Neutral soap solution: two tablespoons maximum in 1 litre of water

Fabrics, artificial, Alcantara leather

Problem	Solution
Particles of dirt stuck to surfaces	Vacuum cleaner
Water-based dirt, e.g. coffee, tea, blood etc.	Absorbent cloth and neutral soap solution ^{a1}

Problem	Solution
Grease-based dirt, e.g. oil, make-up, etc.	Apply a neutral soap solution ^{a1} . Absorb the dissolved grease and paint particles drying with an absorbent cloth, in case you must treat it with water afterwards
Special dirt, e.g. pens, nail polish, dispersion paint, shoe cream etc.	Special stain remove: dry with an absorbent cloth, if applicable, apply neutral soap solution afterwards ^{a1}

^{a1} Neutral soap solution: two tablespoons maximum in 1 litre of water

Natural leather

Problem	Solution
Recent dirt	Cotton cloth with neutral soap solution ^{a1}
Water-based dirt, e.g. coffee, tea, blood etc.	Recent stains: absorbent cloth Dry stains: stain remover suitable for leather
Grease-based dirt, e.g. oil, make-up, etc.	Recent stains: absorbent cloth and suitable stain remover for leather Dry stains: grease solvent spray
Special dirt, e.g. pens, nail polish, dispersion paint, shoe cream etc.	Stain remover suitable for leather

Problem	Solution
Care	Apply preservative cream regularly to protect from sunlight. Use a colour preservative if required

^{a1} Neutral soap solution: two tablespoons maximum in 1 litre of water

Carbon fibre parts

Problem	Solution
Dirt	Clean like plastic parts

Take special care with...

Headlights/tail lights

- Do not clean the headlights/tail lights with a dry cloth or sponge.
- Do not use cleaning products that contain alcohol. Risk of cracks!

Wheels

- Do not use for paint wax or other abrasive products.
- If the protective coating on the paint of the rim has been damaged due to stone impacts, scratches, etc., the damage should be repaired immediately.

Camera lenses

- Do not use hot or warm water to remove ice or snow from the camera lenses. Risk of cracking the lens!
- To clean the camera lens, never use abrasive cleaning products or products with alcohol. Risk of scratches and cracks!

Windows

- Remove snow and ice from windows and exterior mirrors with a plastic scraper only. To avoid scratches, the scraper should only be pushed in one direction and not moved to and fro.
- Never remove snow or ice from windows and rearview mirrors with warm or hot water. Risk of cracks on the windows!
- To prevent damage to the heating of the rear window, do not put stickers over the heating elements.

Covers/trims

- Do not use cleaning products or chrome based cleaning agents.

Paint

- The vehicle must be free from dirt and dust before applying wax or care products. Risk of scratches!
- Do not apply wax or care products if the vehicle is exposed to direct sunlight. Risk of damaging the paint job!

- The ambient rust deposits must not be removed through friction. Risk of damaging the paint job!
- Remove cosmetic products and sunlight immediately. Risk of damaging the paint job!

Displays/instrument panel

- The screens, the instrument panel and the trim around it must not be cleaned dry. Risk of scratches!
- Make sure that the instrument panel is switched off and cooled down before cleaning.
- Make sure that no liquid leaks between the instrument panel and the trim. Risk of damage!

Control panels

- Make sure that no liquid leaks into the control panels. Risk of damage!

Seat belts

- Do not remove the seat belts to clean them.
- Seat belts and their components must never be cleaned with chemical products, nor should they be allowed to come into contact with corrosive liquids, solvents or sharp objects. Risk of damaging the fabric!
- If you find any damage to the belt webbing, belt fittings, the belt retractor or the buckle, ask your specialised workshop to replace the belt in question.



Fabrics/artificial leather/Alcantara leather

- Do not treat artificial leather/Alcantara leather with leather cleaning products, solvents, wax polish, shoe cream, stain removers or similar products.
- If the stain is very hard to remove, take the vehicle to a specialised workshop to have it removed there. This will prevent damage.
- Do not use steam cleaners, brushes, hard sponges, etc. to clean.
- Do not turn on seat heating* to dry the seats.
- Sharp objects on clothing, such as zips, rivets or belts can damage the surface.
- Open Velcro, e.g. on clothes can damage the seat upholstery. Make sure that Velcro fasteners are closed.

Natural leather

- Never use solvents, wax polish, shoe cream, spot removers or similar products on leather.
- Sharp objects on clothing, such as zips, rivets or belts can damage the surface.
- Do not use steam cleaners, brushes, hard sponges, etc. to clean.
- Do not turn on seat heating* to dry the seats.
- Avoid exposing leather to direct sunlight for long periods, otherwise it may tend to lose some of its colour. If the car is left for a pro-

longed period in the bright sun, it is best to cover the leather.

WARNING

Do not use water-repellent coatings on the windscreen. In bad visibility conditions such as humid weather, darkness or when the sun is in its lowest point, visibility may be impacted. Risk of accident! Such coatings can also cause the windscreen wiper blades to make noise.

Note

- **Remains of insects can be removed much more easily with previously treated paint.**
- **Regular car care treatments can prevent deposits of ambient rust.**

Remove the vehicle from traffic

If you want to leave your vehicle stationary for a long period of time, contact a qualified workshop. They will gladly inform you about the necessary measures, such as anti-corrosion protection, Service and storage.

Also take into account instructions regarding the vehicle's battery »» page 273.

Accessories and modifications to the vehicle

Accessories, spare parts and repair work

Introduction

Always ask your dealer or specialist retailer for advice before purchasing accessories and replacement parts.

Your vehicle is designed to offer a high standard of active and passive safety. For this reason, we recommend that you ask a SEAT Official Service for advice before fitting accessories or replacement parts. Your SEAT Official Service has the latest information from the manufacturer and can recommend accessories and replacement parts which are suitable for your requirements. They can also answer any questions you might have regarding official regulations.

We recommend only using **SEAT accessories** and **genuine SEAT parts**®. SEAT has tested these parts and accessories for suitability, reliability and safety. SEAT Official Services have the necessary experience and facilities to ensure that the parts are installed correctly and professionally.

Any **retro-fitted equipment** which has a direct effect on the vehicle and/or the way it is driven, such as a cruise control system **or electronically-controlled suspension**, must be approved for use in your vehicle and bear the **e** mark (the European Union's authorisation symbol).

If **any additional electrical devices** are fitted which do not serve to control the vehicle itself (for instance a refrigerator box, laptop or ventilator fan, etc.), they must bear the **CE** sign (manufacturer conformity declaration in the European Union).

WARNING

Accessories, for example telephone holders or cup holders, should never be fitted on the covers, or within the working range of the airbags. Otherwise, there is a danger of injury if the airbag is triggered in an accident.

Technical modifications

Unauthorised modifications to the electronic components, software, wiring or data transfer in the vehicle may cause malfunctioning.

You will appreciate that your SEAT dealership cannot be held liable for any damage caused by modifications and/or work performed incorrectly.

For this reason we recommend asking official SEAT service centres to do any necessary work using **genuine SEAT parts®**.

WARNING

Incorrectly performed modifications or other work on your vehicle can lead to malfunctions and cause accidents.

Radio telephones and office equipment

Radio transmitters (fixed installation)

Any retrofit installations of radio transmitters in the vehicle require prior approval. SEAT generally authorises in-vehicle installations of approved types of radio transmitters provided that:


- The antenna is installed correctly.
- The aerial is installed on the exterior of the vehicle (and shielded cables are used together with non-reflective aerial trimming).
- The effective transmitting power does not exceed 10 Watts at the aerial base.

A SEAT Official Service and specialised workshop will be able to inform you about options for installing and operating radio transmitters with a *higher* transmitting power.

Mobile radio transmitters

Commercial mobile telephones or radio equipment might interfere with the electronics of your vehicle and cause malfunctions. This may be due to:

- No external aerial.
- External aerial incorrectly installed.
- Transmitting power more than 10 W.

You must, therefore, do not operate portable mobile telephones or radio equipment *inside the vehicle* without a properly installed external aerial **»»** .

Please note also that the maximum range of the equipment can only be achieved with an *external* aerial.

Business equipment

Retrofit installation of business or private equipment in the vehicle is permitted, provided the equipment cannot interfere with the driver's immediate control of the vehicle and that any such equipment carries the **CE** mark. Any retrofit equipment that could influence the driver's control of the vehicle must have a type approval for your vehicle and must carry the **e** mark.

WARNING

Mobile telephones or radio equipment which is operated inside the vehicle without **»**

a properly installed external aerial can create excessive magnetic fields that could cause a health hazard.

Note

- The posterior fitting of electric and electronic equipment in this vehicle affects its licence and could lead to the withdrawal of the vehicle registration document under certain circumstances.
- Please use the mobile telephone/radio operating instructions.

Information for the user

Information for the user

Information stored by the control units

Storage of accident data (Event Data Recorder)

Your vehicle has an event data recorder (EDR).

The EDR's function is to record data in the event of a mild or serious accident. These data are used to support the analysis of how different vehicle systems behaved.

The EDR records, over a reduced time range (normally 10 seconds or less), dynamic driving data and data from the restraint systems, such as:

- How different vehicle systems worked.
- Whether the driver and the occupants were wearing their seat belts.
- How hard the acceleration or brake pedal was pressed.
- Vehicle speed.

These data will provide a better understanding of the circumstances of the accident.

Data from the driving assist systems are also recorded. This includes data such as whether the systems were inactive or active and if such action had an impact on the vehicle's dynamic behaviour, changing its path in the aforementioned situations, accelerating or decelerating the vehicle.

Depending on vehicle equipment, this includes data from systems such as:

- Adaptive Cruise Control (ACC)
- Emergency brake assistance system (Front Assist).
- Park Pilot system

The EDR data are only recorded in specific accident situations. No data are recorded in normal driving conditions.

No audio or video data inside or around the vehicle are recorded. Under no circumstances are personal data such as name, age, or gender recorded. Nevertheless, third parties (such as criminal proceedings authorities) may relate the contents of the EDR data to other data sources and create a personal reference in the context of an accident investigation.

In order to read the EDR data it is necessary to access (if legally permitted to do so) the vehicle's OBD ("On-Board-Diagnose") interface while the vehicle is switched on.

SEAT will not have access to EDR data unless the owner (or, in "Leasing" cases, the lessee or hirer) gives their consent. There may be exceptions to this, depending on legal or contractual provisions.

Due to legal requirements in safety-related products, SEAT may use the EDR data for field research and in order to improve vehicle system quality. Any data used for the purposes of research will be treated anonymously (in other words, no reference will be made to the vehicle, their owner or the lessee/hirer).

Other important information

Environmental compatibility

Environmental protection is a top priority in the design, choice of materials and manufacture of your new SEAT.

Constructive measures to encourage recycling

- Joints and connections designed for easy dismantling.
- Modular construction to facilitate dismantling.
- Increased use of single-grade materials. »

- Plastic parts and elastomers are marked in accordance with ISO 1043, ISO 11469 and ISO 1629.

Choice of materials

- Use of recycled materials.
- Use of compatible plastics in the same part if its components are not easily separated.
- Use of recycled materials and/or materials originating from renewable sources.
- Reduction of volatile components, including odour, in plastic materials.
- Use of CFC-free coolants.

Ban on heavy metals, with the exceptions dictated by law [Annex II of ELV Directive 2000/53/EC]: cadmium, lead, mercury, hexavalent chromium.

Manufacturing methods

- Reduction of the quantity of thinner in the protective wax for cavities.
- Use of plastic film as protection during vehicle transport.
- Use of solvent-free adhesives.
- Use of CFC-free coolants in cooling systems.
- Recycling and energy recovery from residues (RDF).
- Improvement in the quality of waste water.

- Use of systems for the recovery of residual heat (thermal recovery, enthalpy wheels, etc.).
- The use of water-soluble paints.

Recycling of electrical or electronic devices

All electrical or electronic devices (EED) that are not permanently fitted in the vehicle must be marked with the following symbol:



This symbol indicates that EED must not be discarded as home waste but through selective waste collection.

Information about the EU Directive 2014/53/EU

Simplified EU compliance declaration

Your vehicle has different radioelectrical devices. The manufacturers of these devices declare that they comply with Directive 2014/53/EU when legally required.

The full text of the EU compliance declaration is available online at the following address:

www.seat.com/generalinfo



Addresses of the manufacturers

According to the Directive 2014/53/EU, all relevant components must include the address of the manufacturer.

The address of the manufacturers of components that, due to their size or nature, cannot include a sticker are listed below, as long as it is legally required:

Radioelectrical equipment fitted in the vehicle	Addresses of the manufacturers
Radiofrequency remote control key	Della KGaA Hueck & Co. Rixbecker Straße 75 59552 Lippstadt, GERMANY
Radio frequency remote control (auxiliary heater)	Digades GmbH Äußere Weberstraße 20 02763 Zittau, GERMANY
Transmitted-Receiver (independent heating)	Webasto Thermo & Comfort SE Friedrichshafener Str. 9 82205 Gilching, GERMANY

Radioelectrical equipment fitted in the vehicle	Addresses of the manufacturers
Radar sensors for assistance systems	ADC Automotive Distance Control Systems GmbH Peter-Dornier-Straße 10 88131 Lindau, GERMANY
	Robert Bosch GmbH Postfach 16 61 71226 Leonberg, GERMANY

Frequency bands, station power

Radioelectrical equipment ^{a)}	Frequency band	Max. station power	Valid for models
Radiofrequency remote control (vehicle)	433.05-434.78 MHz	10 mW (ERP)	All SEAT models
	433.05-434.79 MHz	10 mW	
	868.0-868.6 MHz	25 mW	
	434.42 MHz	32 µW	
Radio frequency remote control (auxiliary heater)	868.7-869.2 MHz (869.0 MHz)	25 mW	Leon, Ateca and Tarraco
	868.0-868.6 MHz (868.3 MHz)	3.1 mW	Alhambra
Transmitted-Receiver (independent heating)	868.0-868.6 MHz (868.3 MHz)	23.5 mW	Alhambra
	868.7-869.2 MHz (869.0 MHz)	23.5 mW	Leon, Ateca and Tarraco
Bluetooth	2402-2480 MHz	6 dBm	All SEAT models
	2400-2483.5 MHz	10 dBm	

»

Information for the user

Radioelectrical equipment ^{a)}	Frequency band	Max. station power	Valid for models
Connection to the external antenna of the car	GSM 900: 880-915 MHz	33 dBm	Leon, Ateca, Alhambra and Tarraco
	GSM 1800: 1710-1785 MHz	30 dBm	
	WCDMA FDD I: 1920-1980 MHz	24 dBm	
	WCDMA FDD III: 1710-1785 MHz	21 dBm	
	WCDMA FDD VIII: 880-915MHz	21 dBm	Tarraco and Leon
	LTE FDD1: 1920-1980 MHz	23 dBm	
	LTE FDD3: 1710-1785 MHz	23 dBm	
	LTE FDD7: 2500-2570 MHz	23 dBm	
	LTE FDD8: 880-915 MHz	23 dBm	
	LTE FDD20: 832-862 MHz	23 dBm	
Wireless hotspot	2400-2483.5 MHz	10 dBm	Leon, Ateca and Tarraco
Keyless Access	434.42 MHz	32 μ W	Ibiza, Arona, Leon, Ateca and Tarraco
Radar sensors for assistance systems	76 GHz-77 GHz	28.2 dBm	Leon and Alhambra
		35.0 dBm	Ibiza, Arona, Ateca and Tarraco
	24050-24250 MHz	20 dBm	Arona, Ateca, Tarraco and Alhambra
Wireless charging	110-120 kHz	10 W	Ibiza, Arona, Leon, Ateca and Tarraco
	111-120 kHz	10 W	New Leon
Instrument panel	125 kHz	40 dB μ A/m	Ibiza, Arona, Ateca, Tarraco and Alhambra

Radioelectrical equipment ^{a)}	Frequency band	Max. station power	Valid for models
Online Connectivity Unit	EGSM900: 880-915 MHz	33 dBm	Ibiza, Arona, Leon, Ateca and Tarraco
	DCS1800: 1710-1785 MHz	31 dBm	
	UMTS FDD 1: 1920-1980 MHz	24 dBm	
	UMTS FDD 3: 1710-1785 MHz	24 dBm	
	UMTS FDD 8: 880-915 MHz	24 dBm	
	E-UTRA FDD 1: 1920-1980 MHz	23.5 dBm	
	E-UTRA FDD 3: 1710-1785 MHz	23.0 dBm	
	E-UTRA FDD 7: 2500-2570 MHz	23.5 dBm	
	E-UTRA FDD 8: 880-915 MHz	23.0 dBm	
	E-UTRA FDD 20: 832-862 MHz	23.5 dBm	
E-UTRA FDD 28: 703-748 MHz	23.0 dBm		

^{a)} The commissioning or authorisation of radioelectrical technology may be restricted in some European countries, forbidden or only allowed with additional requirements.

Hereby, Molex CVS Dabendorf GmbH declares that the radio equipment type LTE-MBC-EU2 is in compliance with Directive 2014/53/EU. The full text of the EU declaration of conformity is available at the following internet address:

<http://www.molex.com/doc>

Technical data

Indications about the technical data

Important information

Introduction

The values indicated in the technical data may differ depending on optional equipment or version of the model, as well as in the case of special vehicles and equipment for certain countries.

The information in the official vehicle documentation takes precedence at all times.


Abbreviations used in the Technical Specifications section

kW	Kilowatt, engine power measurement.
PS	Pferdestärke [horsepower], formerly used to denote engine power.
rpm, 1/min	Revolutions per minute - engine speed.
Nm	Newton metres, unit of engine torque.
CZ	Cetane number, indication of the diesel combustion power.
RON	Research octane number, indication of the knock resistance of petrol.

Vehicle identification data

Vehicle ID number

The vehicle ID number can be found in the following places:

- In the infotainment system using the button **CAR** /  > **SETTINGS** > **Service** > **Vehicle ID number**.
- One the vehicle's data label.
- In front, under the windscreen.
- To the right in the engine compartment.

Type plate

The type plate is located on the vehicle's right hand door frame. Vehicles for certain export countries do not have a type plate.

Fuel consumption

Approved consumption values are derived from measurements performed or supervised by certified EU laboratories, according to the legislation in force at the time [for more information, see the Publications Office of the European Union on the EUR-Lex website: © European Union, <http://eur-lex.europa.eu/>] and apply to the specified vehicle characteristics.

The values relating to fuel consumption and CO₂ emissions can be found in the documen-

tation provided to the purchaser of the vehicle at the time of purchase.

Fuel consumption and CO₂ emissions depend on the equipment/features of each individual vehicle, as well as on the driving style, road conditions, traffic conditions, environmental conditions, load or number of passengers.

Filling capacities

Tank level

Petrol and diesel engines	40 l, 7 l reserve
Natural gas engine^{a)}	approx. 13.8 kg Additional petrol tank: 9 l, of which approx 7.6 l is a reserve

^{a)} The capacity depends on the efficacy and characteristics of the natural gas pumps. The capacity indicated is based on a minimum loading pressure of 200 bar.

Capacity of the windscreen washer fluid container

Windscreen washer fluid container	approx. 3 litres
-----------------------------------	------------------

Weights

Load on the roof

The maximum authorised roof load for your vehicle is 75 kg.

Empty weight, total weight, axle loads

The empty weight of the vehicle with driver (75 kg) was calculated according to the (EU) 1230/2012 standard. Optional equipment can increase the empty weight, which means that the possible useful load decreases proportionally.

Trailer weight

The maximum permitted drawbar load on the ball head of the towing bracket is **50 kg**.

WARNING

The values indicated for the maximum permitted weights must not be exceeded.
There is a risk of accident and damage!

Engine specifications

Petrol engines	1.0 MPI Start-Stop	1.0 MPI Evo Start-Stop	1.0 TSI Start-Stop
Power output in kW (PS) at 1/min	55 (75)/6,200	59 (80)/6,250	70 (95)/5,500
Maximum torque (Nm at 1/min)	95/3,000-4,300	93/3,750	175/1,500-4,000
No. of cylinders/displacement (cm ³)	3/999	3/999	3/999
Fuel	Super 95 / Normal 91 (with a slight power loss) ROZ		
Gearbox	manual	manual	manual
Top speed (km/h)	167 (IV)	169 (V)	a)
Acceleration from 0-100 km/h (seconds)	14.7	14.7	a)
Maximum authorised weight (kg)	1,525-1,620 ^{b)}	1,525-1,620 ^{b)}	1,545-1,640 ^{b)}

a) Data not available as this edition goes to print.

b) Varies depending on the features.

Petrol engines	1.0 EcoTSI Start-Stop			1.6 MPI	
Power output in kW (PS) at 1/min	70 (95)/5,000-5,500	85 (115)/5,000-5,500		81 (110)/5,800	
Maximum torque (Nm at 1/min)	175/2,000-3,500	200/2,000-3,500		155/3,800-4,000	
No. of cylinders/displacement (cm ³)	3/999	3/999		4/1,598	
Fuel	Super 95 / Normal 91 (with a slight power loss) ROZ				
Gearbox	manual	manual	automatic	manual	automatic
Top speed (km/h)	182 (IV)	193 (V)	193 (VI)	190	192
Acceleration from 0-100 km/h (seconds)	10.9	9.3	9.5	10.4	10.8
Maximum authorised weight (kg)	1,545-1,640 ^{a)}	1,565-1,660 ^{a)}	1,585-1,680 ^{a)}	1,545-1,640 ^{a)}	1,575-1,670 ^{a)}

a) Varies depending on the features.

Indications about the technical data

Natural gas / petrol engine	1.0 TGI Start-Stop
Power output in kW [PS] at 1/min	66 [90]/4,000-5,500
Maximum torque [Nm at 1/min]	160/1,800-3,800
No. of cylinders/displacement [cm ³]	3/999
Fuel	CNG
	Super 95 / Normal 91 (with a slight power loss) ROZ
Gearbox	manual (VI)
Top speed [km/h]	180 (V)
Acceleration from 0-100 km/h (seconds)	12.1
Maximum authorised weight [kg]	1,690
Diesel engines	1.6 TDI CR Start-Stop
Power output in kW [PS] at 1/min	70 [95]/2,750-4,600
Maximum torque [Nm at 1/min]	250/1,500-2,600
No. of cylinders/displacement [cm ³]	4/1,598
Fuel	Diesel according to standard EN 590, min. 51 CN
Gearbox	manual
Top speed [km/h]	182 (IV)
Acceleration from 0-100 km/h (seconds)	11.3
Maximum authorised weight [kg]	1,655-1,750 ^{a1}

^{a1} Varies depending on the features.

Dimensions

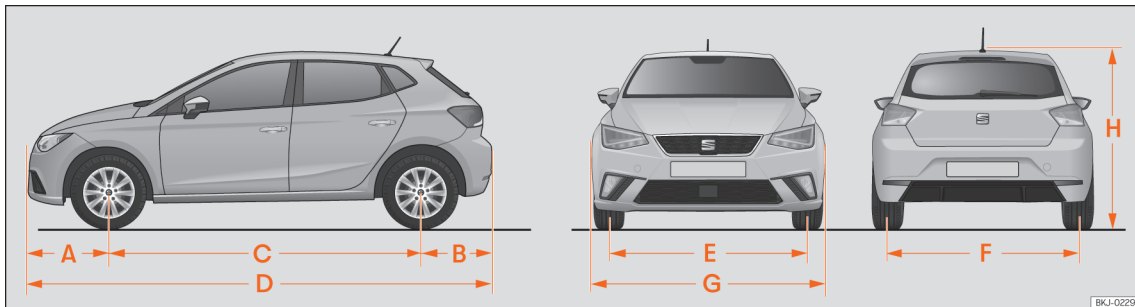


Fig. 198 Dimensions.

Fig. 198		IBIZA
A/B	Front and rear projections (mm)	796/699
C	Wheelbase (mm)	2,564
D	Length (mm)	4,059
E/F	Front/rear ^{d)} track width (mm)	1,525/1,505
G	Width (mm)	1,780
H	Height at kerb weight (mm)	1,444

^{d)} This data will change depending on the type of wheel rim. Values for wheel 185/70 R14 ET38.

Index

Numbers and Symbols

12-volt battery

assisted start	49
charging	275
disconnect and connect	82, 273
replacement	275
winter operations	273

A

ABS

see Anti-lock brake system	231
----------------------------------	-----

ACC	222
-----------	-----

Accessories	139, 294
-------------------	----------

Activating SEAT CONNECT	158
-------------------------------	-----

Active cylinder management (ACT)

status indication	71
-------------------------	----

Adapting the playback volume	153
------------------------------------	-----

Adaptive Cruise Control	222
-------------------------------	-----

control and warning lamp	223
--------------------------------	-----

indications on the screen	225
---------------------------------	-----

malfunction	227
-------------------	-----

noises	227
--------------	-----

operation	223
-----------------	-----

special driving situations	225
----------------------------------	-----

AdBlue

control and warning lamps	260
---------------------------------	-----

information	260
-------------------	-----

loading	261
---------------	-----

minimum filling capacity	260
--------------------------------	-----

specification	261
---------------------	-----

tank capacity	260
---------------------	-----

Adjust

front seats	126
-------------------	-----

headrest	127
----------------	-----

lights	120
--------------	-----

seats	13
-------------	----

time	77
------------	----

Adjusting the seat belt	20
-------------------------------	----

Airbags	22
---------------	----

description	22
-------------------	----

Airbag system	22
---------------------	----

activation	23
------------------	----

control lamp	24
--------------------	----

deactivation of the front airbag	26
--	----

description	22
-------------------	----

front airbags	24
---------------------	----

how it works	23
--------------------	----

Air conditioning

Climatronic	141
-------------------	-----

manual air conditioning	142
-------------------------------	-----

usage instructions	143
--------------------------	-----

Air recirculation	144
-------------------------	-----

Air vents	144
-----------------	-----

Alternator

warning lamp	274
--------------------	-----

Ambient lighting	121
------------------------	-----

Android Auto™

Disconnecting	165
---------------------	-----

establish connection	165
----------------------------	-----

menu	164
------------	-----

requirements	164
--------------------	-----

special characteristics	165
-------------------------------	-----

Anti-lock brake system	231
------------------------------	-----

Anti-puncture	40, 41
---------------------	--------

Anti-puncture kit	40
-------------------------	----

check after 10 minutes	43
------------------------------	----

components	41
------------------	----

inflating the tyre	41
--------------------------	----

sealing the tyre	41
------------------------	----

Anti-puncture set	40
-------------------------	----

Anti-theft alarm system	105
-------------------------------	-----

trailer	245
---------------	-----

Anti-trap function

sunroof	114
---------------	-----

sunshade blind (glass roof)	114
-----------------------------------	-----

windows	112
---------------	-----

Antifreeze	269
------------------	-----

Apple CarPlay

Disconnecting	164
---------------------	-----

establish connection	164
----------------------------	-----

menu	163
------------	-----

requirements	163
--------------------	-----

special characteristics	164
-------------------------------	-----

Applications (apps)	163
---------------------------	-----

Aspects to think about before starting the vehicle	12
--	----

ASR

see Traction control system	231
-----------------------------------	-----

Assistance systems

adaptive cruise control	222
-------------------------------	-----

cruise control	213
----------------------	-----

driver alert system	76
---------------------------	----

emergency braking (Front Assist)	219
--	-----

front radar	212
-------------------	-----

general notes	211
---------------------	-----

parking aid Plus	236
------------------------	-----

rear parking aid	238
------------------------	-----

safety advice	211
---------------------	-----

speed limiter	216
---------------------	-----

- system limits 211
 tyre control 282
 Tyre pressure monitor indicator 282
 Assisted start 49
 Audible warning
 control and warning lamps 84
 lights 115
 unbuckled seat belt 16
 Auto Lock (central locking) 99
 Automatic car wash 290
 Automatic dipped beam headlight control ... 115
 Automatic gearbox 199
 control lamp 199
 downhill assistant 203
 driving tips 202
 emergency release of the selector lever... 205
 ignition key extraction lock 191
 kick-down 202
 operating fault 202
 selector lever lock 200
 selector lever positions 199
 steering wheel with shift paddles 201
 tiptronic 199, 201
 towing 52
 Average fuel consumption 70
- B**
- Backrest of the rear seat
 folding 128
 raise 128
 Bag hooks 138
 Battery 97
 Before starting the vehicle 12
 Belt tightening 21
 Biodiesel 259
- Blown bulbs
 change a bulb 59
 Bluetooth® 156
 profiles 156
 Bonnet 264, 266
 opening and closing 265
 Brake fluid 271
 Brakes 228
 brake fluid 271
 brake servo 228
 braking assistant 231
 new brake pads 228
 Braking assistant 231
 Braking system
 warning lamp 228
- C**
- Capacities
 AdBlue tank 260
 natural gas tank 256
 window washer water 272
 Care
 see Cleaning the vehicle 289
 Catalytic converter 263
 Central locking 98
 anti-theft alarm 105
 central locking switch 101
 emergency lock 108
 Keyless Access 101
 remote control key 100
 selective unlocking system 100
 settings 100
 Cetane index (diesel fuel) 259
- Change a bulb 59
 dipped beam headlights 61
 DRL/side light (daytime running light) 61
 front fog light 62
 interior light and reading light 64
 luggage compartment lighting 64
 main beam headlights 60
 number plate light 63
 tail light bulb 62
 turn signal 61
 Change the wiper blades 48
 Changing a wheel 43
 subsequent work 47
 wheel nuts 45
 Changing parts 294
 Checking levels
 engine compartment 266
 Check lists
 requirements for Android Auto™ 164
 requirements for Apple CarPlay 163
 requirements for MirrorLink® 165
 Childproof locks
 electric windows 110
 Child seats
 group classification 29
 ISOFIX system 33
 safety instructions 30
 securing with the seat belt 36
 Top Tether system 33, 35
 Cleaning the vehicle
 high pressure cleaning equipment 289
 special care 293
 vehicle exterior 291
 vehicle interior 292
 wash the vehicle 289

- Climatronix 141
 Clocks
 set the time 77
 Closing 98
 bonnet 265
 sunroof 113
 windows 110
 Clutch (lamp) 204
 Coming Home 118
 Connectivity 156
 WLAN access point 166
 Connectivity Box 189
 Contact 191
 Control and warning lamps 84
 adaptive cruise control 223
 adBlue 260
 airbags 26
 airbag system 24
 alternator 274
 anti-lock brake system ABS 231
 ASR 231, 233
 audible warning 84
 braking system 228
 cruise control (GRA) 213
 diesel preheating system 262
 EDL 231
 electromechanical steering 206
 electronic parking brake 228
 emissions control 262
 engine coolant 80
 engine management 262
 engine oil 267
 ESC 231, 233
 fuel reserve 78
 gear change 204
 lights 115
 particulate filter 262, 263
 press on the brake 219, 222
 refuelling 78, 255
 replacement 199
 seat belt 16
 speed limiter 216
 Start-Stop 196
 steering column lock 206
 tyre pressure loss indicator 282
 Controls and displays
 overview 67
 Controls on the steering wheel 91, 94
 Convenience close function
 windows 111
 Convenience open function
 windows 111
 Cooling system
 check the coolant 270
 refilling coolant 270
 Copyright 154
 Correct sitting position 13
 driver 13
 Cruise control 213
 control and warning lamp 213
 operation 215
 Current 139
 Current documentation attached 146
- D**
- Dangers of not using the seat belt 18
 Data label 302
 Data transfer 157
 Deactivating SEAT CONNECT services 161
 Deactivation of cylinders
 see Active cylinder management (ACT) 71
 Deactivation of the front airbag 26
 Diesel
 engine oil 266
 particulate filter 263
 preheating 191
 refuelling 259
 Disposal
 seat belt tensioners 21
 Distance control
 see Adaptive Cruise Control 222
 Door cylinder 108
 Door handle 108
 Door lock 108
 Doors 107
 child lock 109
 Downhill assistance function 203
 Downhill assistant 203
 Drawers 137
 Drink holder
 bottle holder 138
 Driver
 see Correct sitting position 13
 Driver alert system 76
 Driving
 driving on flooded roads 210
 economical 209
 parking on inclines 234
 park on upward slopes 234
 safe 12
 trips abroad 120, 210
 with trailer 247, 248, 253
 Driving data 74
 Driving data indicator 74

- Driving mode 207
- Driving on flooded roads 210
- Driving profile 207
- DSG 199
- Duplicate keys 96
- Dust and pollen filter 140
- Dynamic headlight range control 120

- E**
- e-Call 38
- E10
 - see Ethanol (fuel) 259
- EDL
 - see Electronic differential lock 231
- Electric
 - windows 110
- Electrical accessories
 - see Power socket 139
- Electric windows 110
- Electrolyte 274
- Electromechanical steering 206
 - lamp 206
- Electronic differential lock 231
- Electronic engine torque management
 - [XDS] 232
- Electronic immobilizer 108, 195
- Electronic parking brake
 - lamp 228
- Electronic self-locking 231
- Electronic Stability Control (ESC) 231
- Emergencies 38
 - anti-puncture kit 40
 - changing a wheel 43
 - changing the battery 275
 - emergency vehicle towing 52
 - fire extinguishers 39
 - first aid kit 39
 - hazard warning lights 119
 - jump leads 49
 - replace a blown fuse 57
 - vehicle tool kit 40
 - warning triangle 39
- Emergency braking assist system 212
 - indications on the screen 219
 - malfunction 219
 - operation 221
 - system limitations 222
 - temporarily deactivating 221
- Emergency braking warning 119
- Emergency call 38
- Emergency call service 38
- Emergency locking of the front passenger
 - door 108
- Emergency opening
 - driver's door 108
 - rear lid 110
- Emergency operation
 - front passenger door 108
 - gear selector lever 205
- Emissions control system
 - AdBlue 260
 - catalytic converter 263
 - control lamp 262
 - particulate filter 263
- Engine
 - assisted start 49
 - noises 193
 - preheating 191
 - running in 208
 - Start-Stop system 196
 - starting 191
- Engine and ignition
 - automatic ignition disconnection 192
 - emergency start 195
 - My Beat 195
 - preheat the engine 193
 - starting the engine 193
 - starting the engine with Press & Drive 193
 - switching off the engine 194
- Engine compartment 264, 266
 - battery 273
 - brake fluid 271
 - coolant 269, 270
 - engine oil 268
 - opening and closing 265
 - safety instructions 264
 - window washer tank 272
- Engine coolant 269
 - check the level 270
 - control lamp 80
 - G12evo 269
 - G12 plus-plus 269
 - G13 269
 - specifications 269
 - temperature indicator 80
 - warning lamp 80
- Engine failure
 - control lamp 262
- Engine management 262
 - control lamp 262
- Engine oil
 - change 266, 269
 - checking the oil level 268
 - consumption 268

- dipstick 268
inspection service 266
maintenance frequencies 266
refill 268
specifications 266
- Engine oil pressure
control lamp 267
- Engine specifications 304
- Enlarge
the luggage compartment 128
- Environment
ecological driving 209
environmental compatibility 297
refuelling 255
- Environmental tip
refuelling 255
- Equipment 139, 294
telephone interface 185
- ESC
electronic stability control (ESC) 231
multi-collision brake 232
Sport mode 233
- Ethanol (fuel) 259
- Event Data Recorder 297
- Exhaust gases 262
- Exterior lighting
change a bulb 59
- Exterior mirrors
driving with a trailer 243
folding 125
fold manually 124
heated 125
settings 125
- Exterior view 7, 8
- External antenna 295
- external audio sources
adapting the playback volume 153
- Extinguisher 39
- F**
- Fabrics: clean 292
- Factors that have a negative influence on
safe driving 12
- Fastening rings 134
- Filling capacities
fuel tank 302
window washer tank 302
- Filling the tank 255
- First aid kit
housing 39
- Fog lights with cornering light function 118
- Frequency bands 172
- Front airbags 24
- Front Assist
see Emergency braking assist system 219
- Front drink holders 139
- Front fog light bulb 62
- Front passenger front airbag
control lamp 24
- Fuel
diesel 259
ethanol 259
fuel gauge 78
identification 257
natural gas 259
petrol 258
refuelling 255
saving 209
- Fuel consumption
inertia disconnection 209
why does consumption increase? 262
- Fuel gauge 78
control lamp 78
- Fuel tank cap
opening and closing 255
- Fuel tank flap
opening and closing 255
- Full-LED headlights 59
- Full Link 162
applications 163
settings 163
symbols 163
- Fuses 55
colour coded 56
fuse box 56, 57
preparations for replacing fuses 57
recognise blown fuses 57
replace 57
- G**
- Gear-change recommendation 205
- Gearbox DSG
see Automatic gearbox 199
- Gear change
engage the gears (manual change) 198
manual gearbox 198
- Gear indication 205
- Glove compartment 137
- H**
- Handbrake 230
- Hangers 138

- Hazard warning lights 119
- Head-on collisions and the laws of physics ... 18
- Head-protection airbags
safety instructions 28
- Headlights
change a bulb 59
trips abroad 120
- Headrest 127, 128
- Heating and fresh air 142
- Hill driving assistant 230
- Horn 67
- I**
- Identification of fuels 257
- Identifying letters on engine (LDM)
display 74
- Identity accreditation 159
- Ignition 191
- Ignition key extraction lock 191
- Ignition lock 191
- Inertia mode 203
- Information profiles 70
- Infotainment 86, 146
adapt menus 152
Android Auto™ 164
Apple CarPlay 163
before first use 146
connecting and disconnecting 152
customise 152
customised menus 152
drop-down menu 152
executing functions 152
function buttons 87
initial configuration 88
Internet access 167
- Media mode 175
- MirrorLink® 165
navigation 178
operating 152
overview and controls 150
Radio mode 171
safety instructions 146
share a WLAN connection 167
sound settings 153
system settings 153
telephone interface 185
vehicle information 89
vehicle settings 90
Wi-Fi Protected Setup (WPS) 167
WLAN 167
- Infotainment system
see Infotainment 86
- Inspection 266, 286
- Inspection service 266
- Instrument panel 68, 69
control and warning lamps 84
digital (SEAT Digital Cockpit) 70
display 69
indications on the screen 71, 73
menu structure 73
service intervals display 81
use with the multifunction steering wheel ... 83
use with the wiper lever 83
- Instrument panel display 70, 71
- Instrument panel lighting 121
- Interior door handle 67
- Interior mirror
anti-dazzle 124
- Interior monitoring and the anti-tow system
activation 106
- Interior view 11
- Interlock button 200
- ISOFIX 33
- ISOFIX system 33
- J**
- Jack 40
position points 46
- Jump leads 49
- Jump start 49
description 50
- K**
- Keyless Access
Keyless Entry 101
Keyless Exit 101
Press & Drive 192
special characteristics 103
starting the engine 193
unlocking and locking the vehicle 101
- Keyless Access lock and ignition system:
see Keyless Access 101
- Keyless Entry
see Keyless Access 101
- Keyless Exit
see Keyless Access 101
- Keys
assign a key 96
changing the battery 97
remote control 96
spare key 96
synchronise 98
unlock and lock 100, 108
vehicle key 96

- Key switch 26
- Kick-down
 automatic gearbox 202
 driving profile 208
- L**
- Leather: clean 292
- Leaving Home 118
- Legal provisions 160
- Levels control 302
- Licenses 154
- Lift the vehicle 46
- Light range control 120
- Lights 115
 audible warnings 115
 AUTO 115
 change a bulb 59
 coming home 118
 control and warning lamps 115
 control lighting 121
 controlling the lights 115
 cornering light 118
 daylight 116
 dipped beam headlights 115
 fog light 117
 fog light with cornering light function 118
 headlight range control 120
 instrument lighting 121
 interior light and front reading lights 64
 interior lights 121
 leaving home 118
 luggage compartment lighting 64
 main beam headlight lever 117
 main beam headlights 115
 motorway light 116
- number plate light 63
- reading lights 121
- side lights 115
- switch 115
- switching on and off 115
- turn signal lever 117
- Loading the luggage compartment
 fastening rings 134
 general advice 131
 luggage compartment 110, 131
 positioning the load 131
 positioning the luggage 131
 roof carrier system 135
 trailer 246
- Load on the roof 135
 technical data 135
- Lock and unlock
 in the locking cylinder 108
 with Keyless Access 101
 with the central locking switch 101
- Luggage compartment 110, 131
 emergency unlocking 110
 luggage compartment lighting 121
 storing the rear shelf 132
 variable luggage compartment floor 133
- Luggage compartment floor 133
- Luggage compartment shelf
 storing 132
- Lumbar support 126
- M**
- Main beam headlight lever 117
- Maintenance
 see Service 286
- Maintenance frequencies 266
- Malfunctions
 adaptive cruise control 227
 clutch 204
 emergency brake assistance system (Front Assist) 219
 replacement 204
 sunroof 112
 towing device 244
- Manual gearbox 198
 towing 52
- Mats 15
- Media Mode 175
- MirrorLink®
 Disconnecting 166
 establish connection 165
 menu 165
 requirements 165
 settings 163
 special characteristics 166
- Mirrors
 adjusting the exterior mirrors 125
 anti-dazzle interior 124
 see also Mirrors 124
- Mobile 295
- Mobile phones 295
- Multi-collision brake 232
- Multifunction display 74
- Multifunction steering wheel
 without voice control 94
 with voice control 91
- Multimedia 171, 190
 favourites 176
 play 176
 select source 176
 use streaming services 176

My Beat 195

N

Natural gas 259
 fuel gauge 79
 fuel tank cap 256
 LNG 256
 refuelling 256, 259
 special characteristics 256

Navigation 178
 decrease the navigation map 179
 detailed view 184
 edit route 183
 enter an address for a guide destination ... 181
 favourite destinations 182
 frequent destinations 182
 functions 180
 function: entering destination 181
 increase the navigation map 179
 last destinations 182
 learn usage pattern 184
 limitations 179
 managing the map 179
 map 179, 182
 navigation announcements 178
 offroad mode 182
 Other options 184
 route details 183
 saved data 179, 184
 saved destinations 182
 save destination 182
 split screen 184
 symbols 180
 use contact details 183

use the map 182
 use the map to enter the destination 182

Noise
 brakes 228
 ESC 231
 refuelling natural gas 256
 tyres 276, 280

Number of seats 14

O

Octane (petrol) 258
 Odometer 69, 70
 partial 72
 total 72

Oil change 269
 One-touch signalling function 117
 Online services 157
 Opening 98
 bonnet 265
 sunroof 113
 tank cap 255, 256
 windows 110

Opening and closing 98
 bonnet 265
 by remote control 100
 doors 107
 in the locking cylinder 108
 rear lid 110
 sunroof 113
 tank cap 255, 256
 windows 110
 with the central locking switch 101

Operating fault
 automatic gearbox 202

Operation in winter
 battery 273
 diesel 259
 salt on the roads 123
 snow chains 281
 tyres 280

Original accessories 288
 Original SEAT Spare Parts 288
 Overview (left hand drive) 9
 Overview (right hand drive) 10
 Ownership accreditation 159

P

Painting the vehicle
 care 291

Panoramic sliding sunroof
 see Sunroof 112

Parking 233

Parking aid
 automatic activation 237
 fault 238, 239
 parking aid plus 236
 rear parking aid 238
 sensors and camera: clean 291
 setting the indications and audio signals 238, 239
 surroundings warning 236
 towing device 239
 trailer mode 238
 visual indication 237

Parking aid system
 see Parking aid 234, 236, 238

Parking distance warning system
 see Parking aid 234, 236, 238

Parking (automatic transmission) 202

- ParkPilot
 see Parking aid 234, 236, 238
- Particulate filter 263
- Pedals 14, 15
- Petrol
 additives 258
 particulate filter 263
 refuelling 258
- Places with risk of explosion 186
- Places with special regulations 186
- Power socket 139
- Power sockets
 trailer 244
- Power steering
 see Electromechanical steering 206
- Preheating 191
- Preheating system
 control lamp 262
- Preheat the engine 193
- Press & Drive
 start button 192
 starting the engine 193
- R**
- Radar sensors 212
- Radio 171
 equipment 172
 frequency bands 172
 preset buttons 172
 symbols 172
 tune station 172
 [TP] Traffic information 173
- Radio-operated remote control
 see Keys 96
- Radio mode 171
- Radio screen: clean 292
- Radio telephones 295
- Rain sensor 123
 function control 123
- Raise the vehicle 46
- Rear fog light
 control lamp 115
- Rear lid 110
- Rear lights
 remove the tail light 62
- Rear mounting
 towing device 253
- Rear parking aid 238
- Rear seat
 folding down and raising the backrest 128
- Rear View Camera 239
- Rear window wiper 122
- Refuelling
 control lamp 78
 fuel gauge 78
 gas tank indicator 79
 natural gas 256
 opening the fuel tank flap 255
- Releasing the seat belt 19
- Remote control key
 unlock and lock 100
- Repair work 294
- Requirements for Apple CarPlay 163
- Reverse assist 239
 display 240
 parking 240
 special characteristics 240
 usage instructions 240
- Reverse instructions 239
- Reverse (automatic gearbox) 200
- Revolution counter 69, 70, 78
- Roof carrier 134
 fix the crossbars 135
- Roof carrier system 134
- Roof rack 134
- Rotation direction
 tyres 47
- Running in
 new brake pads 228
 new engine 208
 new tyres 276
- S**
- S-PIN 159
- Safe 195
- Safe driving 12
- Safe security system 104
- Safety
 child safety 29
 child seats 29
 safe driving 12
- Safety equipment 12
- Safety instructions 146
 head-protection airbags 28
 seat belt tensioners 21
 side airbags 27
 using child seats 30
 using seat belts 17
- Save fuel
 inertia mode 203
- Screen 69
 clean 154
- Seat
 removable covers 129

- Seat belts 16
 adjustment 19
 control lamp 16
 fitting the seat belt strap 20
 protective function 17
 purpose 16, 22
 safety instructions 17
 unfastened 18
- Seat belt tensioners 21
 control lamp 24
- SEAT CONNECT 157
 deactivate 161
 faults 161
 legal provisions 160
- SEAT Digital Cockpit 70
 information profiles 70
 navigation map 71
- SEAT Drive Profile 207
- Seat heating 145
- SEAT Ident 159
- Seats
 adjusting the headrests 127
 backrest of the rear seat 128
 fitting the headrest 128
 heating 145
 incorrect positions 14
 manual adjustment 126
 number of seats 14
 removing the headrest 128
- SEAT Service Mobility 288
- Seat's Mobility Service 288
- Selective catalytic reduction 260
- Selective unlocking system 100
- Selector lever lock 200
- Selector lever (automatic gearbox)
 emergency unlocking 205
 positions 199
- Selling the vehicle 160
- Service
 Digital Maintenance plan 286
 flexible service 286
 inspection 286
 oil change service 286
 proof of Service 286
 services 286
 service sets 288
 service works 286
 set service intervals 286
 terms of use 287
- Service interval display 287
- Service intervals 81
- Service Menu
 identifying letters on engine 74
 restart the oil service 74
 restart Trip 74
 service intervals display 74
 time 74
- Service notification: consult 81
- Set of vehicle keys 96
- Shift paddles (automatic transmission) 201
- Side airbags
 safety instructions 27
- Snow chains 281
- Sound settings 153
- Sound system 155
- Spanner symbol 81
- Spare parts 294
- Spare wheel 284
- Special characteristics
 Android Auto™ 165
 Apple CarPlay 164
 MirrorLink® 166
 towing 51, 53
 tow start 51
 trailer mode 247
- Speed limiter 216
 control lamp 216
 indication on display 216
 operating 218
- Speed symbol 276
- Speed warning 75
- Sport Mode 233
- Stabilisation of the towing vehicle and trailer
 combination 248
- Start-Stop 196
- Start-Stop system
 disconnect and connect 198
 driver indications 196
 how it works 196
 lamps 196
 stopping and starting the engine 196
 the engine does not turn off 196
 the engine starts by itself 196
- Starter button 192
- Starting up the engine 191
- Start the engine by towing 52
 special characteristics 51
- Status display 73
 ACT 209
 active cylinder management status [ACT] .. 71
 adaptive cruise control 225
 compass indication 73
 doors, bonnet and rear lid open 72

- ECO 73
- Emergency brake assistance system (Front Assist) 219
- gear-change recommendation 72
- identifying letters on engine 73
- instrument panel 71
- odometer 72
- outside temperature 72
- SEAT Drive Profile 207
- selector lever positions 72, 199
- service intervals 81
- speed limiter 216
- speed warning 72
- time 77
- tyre control 282
- warning and information messages 75
- Steering
- control lamp 206
- electromechanical steering 206
- steering assist 206
- Steering assist 206
- Steering wheel
- adjust 15
- controls 91, 94
- shift paddles (automatic transmission) 201
- Storage compartment 136
- drawers 137
- glove compartment 137
- glove compartment light 121
- on-board documentation 137
- on the front passenger side 137
- other object holders 138
- storage bag in the seat 138
- Storage compartment accessories
- see Storage 136
- Storage of accident data 297
- Storing objects
- fastening rings 134
- loading the trailer 246
- positioning the load 131
- positioning the luggage 131
- roof carrier 134
- roof carrier system 134, 135
- trailer 241
- trailer mode 247
- Sun blind 126
- sliding roof 113
- Sun protection 126
- Sunroof 112
- anti-trap function 114
- closing 113
- malfunction 112
- opening 113
- Sunshade blind
- anti-trap function (glass roof) 114
- Switch
- hazard warning lights 119
- Switching off
- telephone 186
- telephone interface 186
- System settings 153
- T**
- Tail lights
- change a bulb 59
- Technical data 302
- fuel consumption 302
- load on the roof 135
- vehicle dimensions 306
- vertical load on the tow hitch 241
- weights 303
- Technical modifications 295
- Telephone
- contacts 189
- disconnecting 186
- favourites 189
- pairing a mobile phone 187
- Phone book 189
- send messages 188
- speed dial buttons 189
- to call 188
- Telephone interface 185
- places with risk of explosion 186
- Temperature indicator
- exterior 72
- Time
- adjust 74, 77
- Tiptronic (automatic transmission) 199, 201
- To change the battery
- of the vehicle key 97
- To park the vehicle 233
- Top Tether 33, 35
- Top Tether System 33, 35
- Torque
- wheel nuts 47
- Touch screen 150
- Touch zones 150
- Towable loads
- loading the trailer 246
- Tow cable 243, 244
- Tow hook
- fitting 250
- place in the reserve position 249

- removing 252
 - safety check 251
 - Towing bracket device 248
 - description 248
 - operation and conservation 249
 - Towing device 248
 - fitting later 253
 - malfunction 244
 - Towing the vehicle 51, 53
 - automatic gearbox 52, 53
 - front towline anchorage 54
 - manual gearbox 52, 53
 - rear towline anchorage 54
 - special characteristics 51, 53
 - tow bar 52
 - towing cable 52
 - towing prohibited 52
 - with towing device 52
 - Traction control system 231
 - Trademarks 154
 - Traffic information (TP) 173
 - Traffic programme
 - see Traffic information (TP) 173
 - Trailer 241, 248
 - adjusting the headlights 247
 - anti-theft alarm 245
 - connecting 244, 253
 - exterior mirrors 243
 - hitching 244
 - LED tail lights 243, 245
 - loading 246
 - malfunction 244
 - parking aid 238, 239
 - power socket 244
 - retrofitting a towing bracket 253
 - safety lug 253
 - stabilisation of the towing vehicle and trailer combination 248
 - tail lights 243, 245
 - technical requirements 243
 - towable loads 246
 - towing cable 243, 244
 - trailer mode 247
 - vertical load on the tow hitch 241, 246
 - Trailer mode
 - see Trailer 241
 - Transportation of children 29
 - Trips abroad
 - headlights 120
 - petrol 210
 - Turning off the lights 115
 - Turning on the lights 115
 - Turning the ignition on and off 191
 - Turn signal lever 117
 - Tyre Mobility System
 - see Anti-puncture kit 40
 - Tyre monitor system 282
 - Tyre pressure 278
 - Tyre pressure loss indicator
 - Tyre pressure monitor indicator 282
 - Tyre profile 279
 - Tyre repair kit 40
 - see also Anti-puncture kit 40
 - Tyre repairs 40
 - Tyres
 - accessories 276
 - change 43
 - directional tread pattern 47
 - foreign objects inserted 276
 - new tyres 277
 - speed symbol 276
 - tread wear indicators 279
 - tyre pressure 278
 - useful life 278
 - with directional tread pattern 276
 - Tyre tread depth 279
 - Tyre wear 279
- ## U
- Unlock and lock
 - by remote control 100
 - doors 107
 - with Keyless Access 101
 - with the central locking switch 101
 - USB 190
 - USB port 190
- ## V
- Vanity mirror 126
 - Variable luggage compartment floor 133
 - Vehicle
 - data label 302
 - identification data 302
 - identification number 302
 - lending or selling 160
 - parking on inclines 234
 - parking on upward slopes 234
 - raise 46
 - unlocking and locking with Keyless Access 101
 - vehicle ID number 302
 - Vehicle battery
 - electrolyte level 274
 - Vehicle care
 - wiper blade service position 48

- Vehicle conservation products 289
- Vehicle dimensions 306
- Vehicle information 89
- Vehicle location 160
- Vehicle maintenance 289
- Vehicle seats 14
- Vehicle settings 90
- Vehicle tool kit 40
- Vehicle wallet compartment 137
- Vertical load on the tow hitch 241
- loading the trailer 246
- voice control 169
- Android Auto™ 165
- Siri™ (Apple CarPlay™) 164
- Volume
- set for external audio sources 153
- W**
- Warning symbols
- see Control and warning lamps 84
- Warning triangle 39, 119
- Warranty 289
- Washing the vehicle
- conserving the exterior of the vehicle 289
- high pressure cleaning equipment 289
- Weights 303
- Wheel balance 278
- Wheel central trim 43
- Wheel nuts 45, 280
- anti-theft device 44, 45
- caps 44
- torque 47
- Wheels
- change 43, 47
- changing 279
- changing a wheel 43
- new wheels 277
- snow chains 281
- spare wheel 284
- wheel central trim 43
- wheel nuts 280
- wheel trim 44
- Wheel spanner 40
- Wheel trim 44
- remove 44
- Wi-Fi 156
- Window controls 110
- Windows
- automatic opening/closing 111
- automatic operation 111
- convenience closing 111
- convenience opening 111
- Window washer
- window washer lever 122
- Window washer system 272
- Window washer water
- check 272
- filling quantities 272
- refill 272
- Windscreen heating 141
- Windscreen washer 122
- Windscreen wipers 122
- functions 123
- lift the blade 48
- rain sensor 123
- reposition the blade 48
- service position 48
- special characteristics 122
- thermal washing ejectors 123
- Winter conditions
- sunroof 112
- trailer 241
- Winter tyres 280
- Wiper and rear window wiper blades
- cleaning 48
- replacement 48
- service position 48
- Wiper blades
- cleaning 291
- Wireless Charger 189
- Wireless charging 189
- WLAN 166
- X**
- XDS 232

SEAT S.A. is permanently concerned about continuous development of its types and models. For this reason we ask you to understand, that at any given time, changes regarding shape, equipment and technique may take place on the car delivered. For this reason no right at all may derive based on the data, drawings and descriptions in this current handbook.

All texts, illustrations and standards in this handbook are based on the status of information at the time of printing. Except for error or omission, the information included in the current handbook is valid as of the date of closing print.

Re-printing, copying or translating, whether total or partial is not allowed unless SEAT allows it in written form.

SEAT reserves all rights in accordance with the "Copyright" Act.

All rights on changes are reserved.

 This paper has been manufactured using bleached non-chlorine cellulose.

© SEAT S.A. - Reprint: 15.07.20

Inglés 6F0012720BH (07.20)



6F0012720BH

